

SYMPATHETIC DETONATION OF AMMONIUM NITRATE AND AMMONIUM NITRATE-FUEL OIL

By R. W. Van Dolah, F. C. Gibson,
and J. N. Murphy

* * * * * report of investigations 6746

www.ARblast.osmre.gov

US Department of Interior
Office of Surface Mining
Reclamation and Enforcement



Kenneth K. Eltschlager
Mining/Explosives Engineer
3 Parkway Center
Pittsburgh, PA 15220
Office: 412.937.2169
Cell: 724.263.8143
Keltschlager@osmre.gov

UNITED STATES DEPARTMENT OF THE INTERIOR
Stewart L. Udall, Secretary

BUREAU OF MINES
Walter R. Hibbard, Jr., Director

This work was supported by many companies contributing through the Manufacturing Chemists' Association, Washington, D.C.

This publication has been cataloged as follows:

Van Dolah, Robert W

Sympathetic detonation of ammonium nitrate and ammonium nitrate-fuel oil, by R. W. Van Dolah, F. C. Gibson, and J. N. Murphy. [Washington] U. S. Dept. of the Interior, Bureau of Mines [1966]

34 p. illus., tables. (U. S. Bureau of Mines. Report of investigations 6746)

Based on work supported by many companies contributing through the Manufacturing Chemists' Association, Washington, D. C.

I. Ammonium nitrate. I. Title. II. Title: Ammonium nitrate-fuel oil. (Series)

TN23.U7 no. 6746 622.06173

U. S. Dept. of the Int. Library

CONTENTS

	<u>Page</u>
Abstract.....	1
Introduction.....	1
Acknowledgments.....	3
Equipment and procedures.....	4
Experimental design.....	4
Donors.....	5
Acceptors.....	6
Instrumentation.....	7
Velocity of detonation.....	9
Pressure gages on donors and acceptors.....	9
Foil switches.....	9
Nonelectric methods.....	10
Photography.....	10
Blast pressure.....	12
Safety precautions.....	13
Materials.....	13
Results.....	14
Instrumental data analyses.....	18
Discussion and conclusions.....	24
References.....	30
Appendix A.--Chronology of program, 1964.....	31
Appendix B.--Estimate of standard deviation of up-and-down results.....	33

ILLUSTRATIONS

Fig.

1. Charge arrangements, using different booster sizes with hard and soft ends.....	6
2. Donor and acceptor in place, and donor booster showing installation of RDX pellets.....	7
3. Instrumentation applied to charge system used in sympathetic detonation studies.....	8
4. Camera with barricade removed and its placement for typical shot..	11
5. Bank of flashbulbs used to provide supplemental lighting for Dynafax camera.....	11
6. BRL self-recording pressure gage separated from case and gage record.....	12
7. Up-and-down results, Series I and II.....	14
8. Up-and-down results, Series III, IV, and V.....	15
9. Up-and-down results, Series VI and VII.....	16

ILLUSTRATIONS--Continued

<u>Fig.</u>	<u>Page</u>
10. Up-and-down results, Series VIII, IX, and X.....	17
11. Schematic of charge-sand barrier arrangement (shot 59).....	18
12. Typical oscillograms (shot 5) from which velocity and pressure are obtained.....	18
13. Oscillograms of velocity records produced in acceptors.....	20
14. Dynafax sequence (shot 32) taken at 20,000 frames per second.....	23
15. Distance-time plot of shock/fragments across gaps for 40-inch donors.....	24
16. Fragment velocities determined by use of foil switches.....	25
17. Blast pressures from AN-FO.....	26
18. Maximum charge separation (53 feet) employed in test series in which a hard-end donor and an AN-FO acceptor were used.....	27
19. Effects of diameter and temperature on initiation pressure.....	28

TABLES

1. Distances used in Bruceton design for three AN-FO donors.....	5
2. Distances determined for 50 percent initiations with correspond- ing K factors.....	17
3. Velocities of detonation determined for AN-FO donors.....	21
4. Summary of initiation result and acceptor detonation velocities..	22
5. K factors from various sources.....	29
B-1. Normalized up-and-down results.....	33

SYMPATHETIC DETONATION OF AMMONIUM NITRATE AND AMMONIUM NITRATE-FUEL OIL

by

R. W. Van Dolah,¹ F. C. Gibson,² and J. N. Murphy³

ABSTRACT

An investigation was made of the distances over which sympathetic detonation of ammonium nitrate (AN) and ammonium nitrate-fuel oil (AN-FO) might be expected. Large-scale gap tests used two types of AN-FO donor charges in three sizes with AN, both at ambient and elevated temperatures, and AN-FO acceptor charges. Donor sizes were varied to test the validity of a scaling law commonly used in quantity distance tables. The up-and-down experimental design was chosen to determine the 50-percent initiation point efficiently. The acceptor charges were instrumented to indicate initiation and to determine detonation velocity. Other electronic techniques for measuring the rate of growth, stability of detonation, and detonation pressures were employed. Air shock and fragment velocities between charges were measured by electronic and photographic methods, and determination of side-on air-blast pressures and impulse duration were made for about half the shots.

Separation distances between donor and acceptor were found to be larger than anticipated both for the AN and the AN-FO. With AN-FO acceptors and a 16-gage steel faced donor, one initiation occurred at a separation of 53 feet or nearly 16-charge diameters; with AN, initiation occurred at 4 to 5-1/2-charge diameters.

INTRODUCTION

Production of ammonium nitrate, in common with other fertilizers, has been undergoing a very rapid expansion in recent years, amounting to about 4,000,000 short tons in the United States during 1963. The fear of ammonium

¹ Research director.

² Project coordinator, explosives physics.

³ Electrical engineer, explosives physics.

All authors are with the Explosives Research Center, Bureau of Mines, Pittsburgh, Pa.

nitrate as a potential explosive, generated by the disaster at Texas City in 1947, has been much allayed by the excellent nonexplosive record that fertilizer-grade ammonium nitrate has had since that time. In the last few years, however, fertilizer-grade ammonium nitrate has been increasingly used as the major ingredient in low-cost and efficient blasting agents; the most popular is a mixture of ammonium nitrate and from 5 to 6 percent fuel oil. Much of the ammonium nitrate-fuel oil is mixed at mine or quarry sites and sometimes actually in the borehole. Increasingly, however, the trend is to a premixed product supplied by explosives manufacturers or by operators of small blending plants located in mining and quarrying districts. Thus, substantial quantities of fertilizer-grade ammonium nitrate are now found near ammonium nitrate blasting agents which, although less susceptible to accidental initiation than conventional explosives, are, nonetheless, powerful explosives.

It has generally been recognized that ammonium nitrate in close proximity to explosives should itself be considered an explosive for determining separation distances of the combined explosive and ammonium nitrate from inhabited buildings, passenger-carrying railroads, public highways, etc. For while raw ammonium nitrate is an insensitive and weak explosive, it is, nonetheless, capable of producing severe damage if it detonates. The Bureau of Mines has recommended "when stocks of ammonium nitrate and AN-FO are stored close to each other, the explosion potential of a fire occurring in either should be based on the sum of the two stocks" (3);⁴ however, the term "close" is not clearly defined. The Ordnance Safety Manual (12) states: "When class 12 materials" (ammonium nitrate is one) "are exposed to high explosives and/or missiles that may initiate the class 12 materials to detonation they shall be considered as class 9 materials and quantity-distance separation shown in tables 1738-1741 shall apply. When located in areas where fire hazard materials only are involved, they should be considered as class 2" (fire hazard only). Again there is a question of what constitutes exposure.

In the absence of pertinent data, the American Table of Distances (6) for intermagazine separation has been frequently used, although there has been a strong feeling that the tabulated distances, being based on what has been considered a safe separation for high explosives, were over-conservative in the instance of insensitive materials such as ammonium nitrate. The required separations frequently made the selection of a suitable site for a mixing plant difficult, if not impossible.

The basic problem can be illustrated by considering an ammonium nitrate-fuel oil mixing plant where ammonium nitrate is received in rail cars on a siding near the mixing plant. The mixer may have in process 1,000 to 2,000 pounds, with the mixed material being accumulated in a truck or van-type trailer for temporary storage and ultimate transportation to a blasting site. Three distances are of interest (1) separation of the cars of raw ammonium nitrate, containing 50 tons or more each, from the AN-FO in process; (2) the separation of mixed material in the van, perhaps amounting to 30,000 pounds, from this same material in the mixer; and (3) separation of raw ammonium nitrate from AN-FO in the van.

⁴ Underlined numbers in parentheses refer to items in the list of references at the end of this report.

Since only limited and small-scale data applicable to the problem were available, the Bureau of Mines was asked by the explosives and ammonium nitrate industries to undertake an investigation of the problem. A cooperative agreement was established between the Bureau and the Manufacturing Chemists' Association. Separately, the Manufacturing Chemists' Association contracted with E. I. duPont de Nemours and Company, Inc., to supply the Bureau field party with necessary materials and services for preparation of the charges. The investigation was carried out in the Barrens of northern Wisconsin at a site approximately 22 miles west of Ashland. This location was chosen because the duPont Company had successfully conducted field trials with charges of the size planned for this program without disturbance to residential areas (the nearest was about 12 airline miles away from the firing site). An ad hoc committee consisting of industry and Bureau representatives was formed to lay out the experimental work and to advise the Bureau as the program progressed.

ACKNOWLEDGMENTS

This investigation was conducted under the terms of a cooperative agreement with the Manufacturing Chemists' Association with financial support provided by the following: Allied Chemical Corp., New York; American Cyanamid Co., Wayne, N. J.; Apache Powder Co., Benson, Ariz.; Armour Agricultural Chemical Co., Atlanta, Ga.; Atlas Chemical Industries, Inc., Wilmington, Del.; Canadian Industries, Ltd., Montreal, Quebec, Canada; Collier Carbon and Chemical Corp., Los Angeles, Calif.; The Consolidated Mining and Smelting Co. of Canada, Ltd., Trail, British Columbia, Canada; The Dow Chemical Co., Midland, Mich.; E. I. duPont de Nemours & Co., Inc., Wilmington, Del.; The Ensign-Bickford Co., Simsbury, Conn.; Escambia Chemical Corp., Albany, Ga.; Hercules Powder Co., Wilmington, Del.; Monsanto Co., St. Louis, Mo.; National Powder Co., Eldred, Pa.; Phillips Petroleum Co., Bartlesville, Okla.; Southern Nitrogen Co., Inc., Savannah, Ga.; Spencer Chemical Division, Gulf Oil Corp., Kansas City, Mo.; Trojan Powder Co., Allentown, Pa.; United States Powder Co., Division of Commercial Solvents Corp., Terre Haute, Ind.; U.S. Steel Corp., Pittsburgh, Pa.

The special ad hoc committee headed by Harrie W. Backes, Monsanto Co., and including William J. Taylor of Atlas Chemical Industries, Inc.; S. J. Porter, representing Spencer Chemical Division, Gulf Oil Corp.; and Frank A. Loving of the E. I. duPont Nemours & Co., Inc., gave frequent and helpful advice. C. H. Winning, of the Eastern Laboratory, and B. A. Semb and his plant staff at Barksdale, Wis., both of duPont, cooperated splendidly and made possible the accelerated pace of the field work. Acknowledged as well is the generosity and assistance of the Explosive Kinetics Group, Ballistic Research Laboratories, Aberdeen Proving Ground, Md.; especially, Ralph Reisler who visited the site to familiarize and instruct Bureau personnel in operation, maintenance, and handling of BRL self-recording pressure gages.

EQUIPMENT AND PROCEDURES

Experimental Design

The experimental design chosen comprised a series of large-scale gap tests in which AN-FO donors were separated by selected distances from raw ammonium nitrate or AN-FO acceptors. Because of concern that the AN-FO might sometimes be present in fragment-producing containers, both plastic-end and 16-gage steel-end donor charges were employed. The acceptor charges were uniformly 40 inches in diameter and 40 inches long; this diameter was chosen because it was amply greater than the critical diameter (the smallest diameter at which detonation is capable of propagating) of the ammonium nitrate chosen--less than 12 inches.⁵ Most of the work was done with similar 40- by 40-inch donors, although smaller donors were used in an attempt to verify the validity of the usual scaling law for quantity-distance tables which is expressed by the equation

$$S = KW^{1/3}$$

where S is the distance in feet, K is a constant of proportionality, and W is the weight in pounds. The distances were varied shot to shot, employing the Bruceton up-and-down method (2, 4), with the distance being increased or decreased depending upon the previous result in the same series. Thus, if initiation of the acceptor charge occurred, for the next shot in the same series (same size donor, same end on the donor charge, and same acceptor charge) the distance was increased. Conversely, if initiation failed to result, the distance was decreased. The Bruceton method, by thus concentrating the trials in the vicinity of the median--the point at which initiation is expected in 50 percent of the trials--is an efficient means of determining the median value. A logarithmic rather than a linear scale of distances was used as extensive application of the Bruceton method had indicated that results obtained with this scale were frequently more normally distributed than when a linear scale was used--normal distribution is a basic assumption of the method. The method also requires that the interval chosen be in the range of one-half to two times the standard deviation (σ) of the population. It is difficult to meet this requirement in advance of the experiment but again reliance was placed on past experience, which indicated that 0.06 units on the common logarithm scale was a reasonable estimate of the standard deviation. A 2σ interval was chosen as being the most efficient interval with which to determine a completely unknown median point as a large interval would waste fewer trials in locating its approximate value than would a small interval; this choice resulted in the scales and actual distances given in table 1. Efficiency was most important because of the cost of the field trials, both in manpower and materials, and the short time before the onset of hunting season and winter (appendix A).

Several charge arrangements were employed to gain an insight into the effect of as many parameters as possible in the time available. All charges were contained in laminated cardboard tubes originally intended for use as

⁵Information supplied by E. I. duPont de Nemours & Co., Inc.

concrete forms. The donors varied by linear scale factors of two and were 10 by 10 inches, 20 by 20 inches, and 40 by 40 inches; typical arrangements are shown in figure 1. The acceptors were all 40 by 40 inches, and the ends facing the donor charge were, with the exception of two shots, of the soft-end type.

TABLE 1. - Distances used in Bruceton design for three AN-FO donors

40-inch size		20-inch size		10-inch size	
Log ₁₀	Gap interval, inches	Log ₁₀	Gap interval, inches	Log ₁₀	Gap interval, inches
1.60	40	1.30	20	1.00	10
1.72	53	1.42	26	1.12	13.2
1.84	70	1.54	35	1.24	17.4
1.96	92	1.66	46	1.36	23
2.08	121	1.78	60	1.48	30.2
2.20	160	1.90	80	1.60	40
2.32	210	2.02	105	1.72	53
2.44	278	2.14	139	-	-
2.56	366	-	-	-	-
2.68	483	-	-	-	-
2.80	636	-	-	-	-

All charges were placed on wooden platforms and, with the exception of a few early shots, had plywood formers to maintain the cylindrical shape of the charges. The donors were aligned on a common axis with the acceptors. Fortunately, the sandy subsoil of northern Wisconsin provided a convenient material for leveling and supporting the charges.

Donors

The donor charges consisted of a 95/5 mixture of AN and oil. The initiated end of the donor and the downstream (farthest away) end of the acceptor closures were two 1/2-inch plywood disks that snugly fitted the paper tubes; these were retained by a row of nails driven through the cardboard cylinders into the plywood. Hatches, about 12 by 12 inches, were cut into the top side of the cylinder near the midpoint for installing instrumentation and for loading the AN or AN-FO. Two types of downstream end closures were used on the donors (1) a soft end, consisting of a 4-mil polyethylene sheet (PE) supported by 1-inch strips of tape reinforced with glass fiber placed about 1 inch apart across the face of the charge, and (2) a hard end, employing a 1/16-inch-thick sheet steel plate held in place by small angle brackets--fabricated from the same plate material--and paper tape. The plate served as source of fragments or projectiles to increase the severity of the stimulus, that is, to supplement the shock with the metal fragments. As for the soft end, the shock was supplemented by bits of lower mass glass tape, polyethylene sheet, and unreacted pills.

The initiation system for the 40-inch donors consisted of an array of 45, 40-gram RDX pellets attached to 48-inch lengths of Primacord⁶ (fig. 2(A)).

⁶ Trade names are used in this report for identification only and endorsement by the Bureau of Mines is not implied.

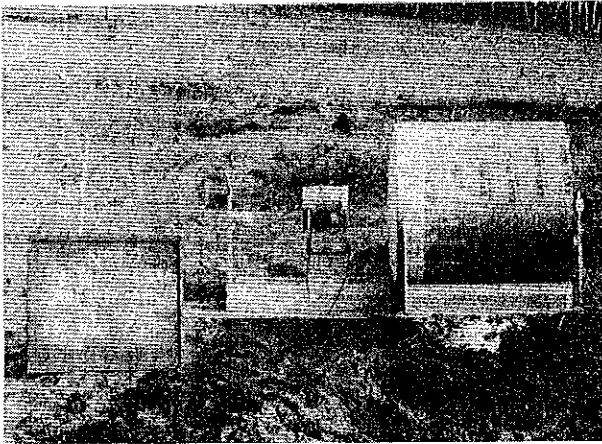

A

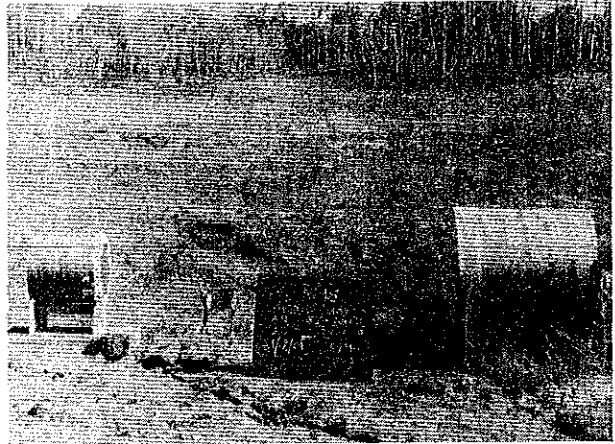

B

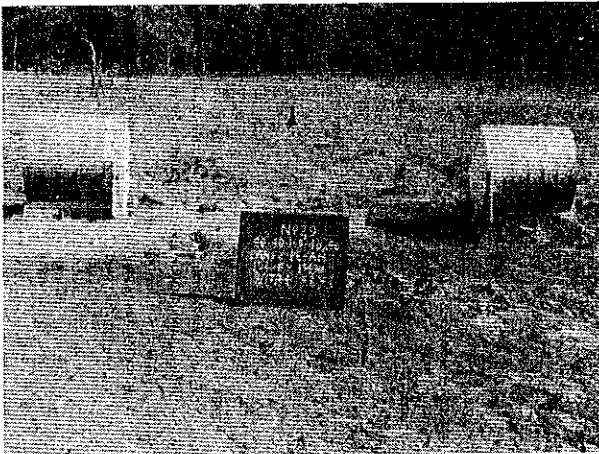

C

FIGURE 1. - Charge Arrangements, Using
 (A) 10'' x 10'' Booster; (B)
 20'' x 20'' Booster With Hard
 End; and (C) 40'' x 40'' Booster
 With Soft End.

The 20- by 20-inch donor employed 19 similar primers with 37-inch Primacord lines, and the 10- by 10-inch donor contained 9 primers with 23-inch lines. The outer ends of the Primacord were gathered onto a duPont HDP-1 booster connected to a Primacord line that extended about 300 feet from the charge to a point where an electric blasting cap was ultimately connected to the end of the firing line. The long line provided increased safety by isolating the large charge when final connections to the firing circuit were being made.

Acceptors

Both AN and AN-FO (95/5) were employed as acceptors. The AN was fired at elevated as well as ambient temperatures; the AN-FO was used only at ambient temperature. For the five AN shots at elevated temperatures, the material was brought to the site in 55 gallon drums in which it had been heated at the plant the previous night; the hot AN was always the first shot of the day and, to expedite the experiment, the charge containers were set up late in the afternoon of the preceding day. The hot AN was transferred in enameled buckets

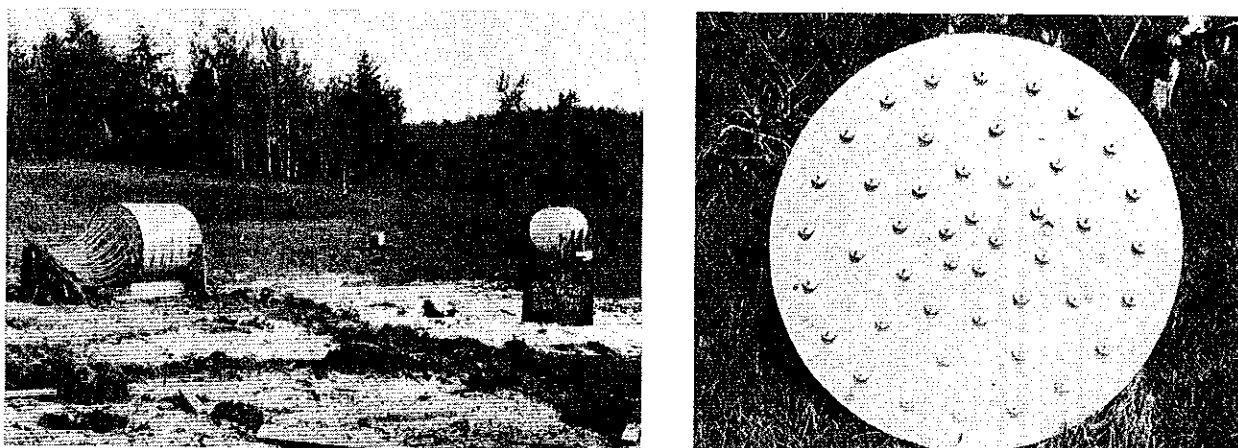

A *B*

FIGURE 2. - (A) Donor and Acceptor in Place; Prills Seen in Foreground Are Result of a Previous Failure of the Acceptor To Be Initiated With a 10" x 10" Donor at Gap Distance of 30 Inches. (B) Donor Booster Showing Installation of RDX Pellets.

to the charge containers. The materials at ambient temperature were transferred directly from 50 pound bags into the charge containers. The load of prills on the polyethylene-tape end caused it to bulge about $1\frac{1}{4}$ inch at the center, whereas the bulge of the metal end in the 40-inch charge was less than three eighths of an inch.

Instrumentation

To obtain as much quantitative information as possible from these large-scale shots of both AN and AN-FO, the instrumentation applied to the explosive system was varied widely. However, the design of the experiment required immediate interpretation of the basic result of each test to permit a choice of separation distance for the next test in the same series. Thus, all shots were immediately qualitatively assessed and classified as being positive (acceptor initiated) or negative (acceptor failed to initiate).

The charge site was in a shallow bowl-like arena, 500 feet across, with the instrumentation truck and preparation facilities located beyond the brow of a hill out of line-of-sight of the charges. The separation was about 800 feet. The 1-ton panel instrumentation truck had been previously equipped with recording instruments and firing control apparatus at the Explosives Research Center in Bruceton and had been driven to the test site in Wisconsin. The firing circuit was energized by a capacitor, charged to about 300 volts, and was protected with triple interlocks, that is, a keylock switch, and arm and fire switches. A time delay of 2 seconds was incorporated to permit activation of the spring-wound motors of air-blast pressure gages--in the vicinity of the charges--prior to firing.

Ten coaxial cables were used between the instrument truck and the charge site; however, two lines terminated in a junction box about 200 feet short of

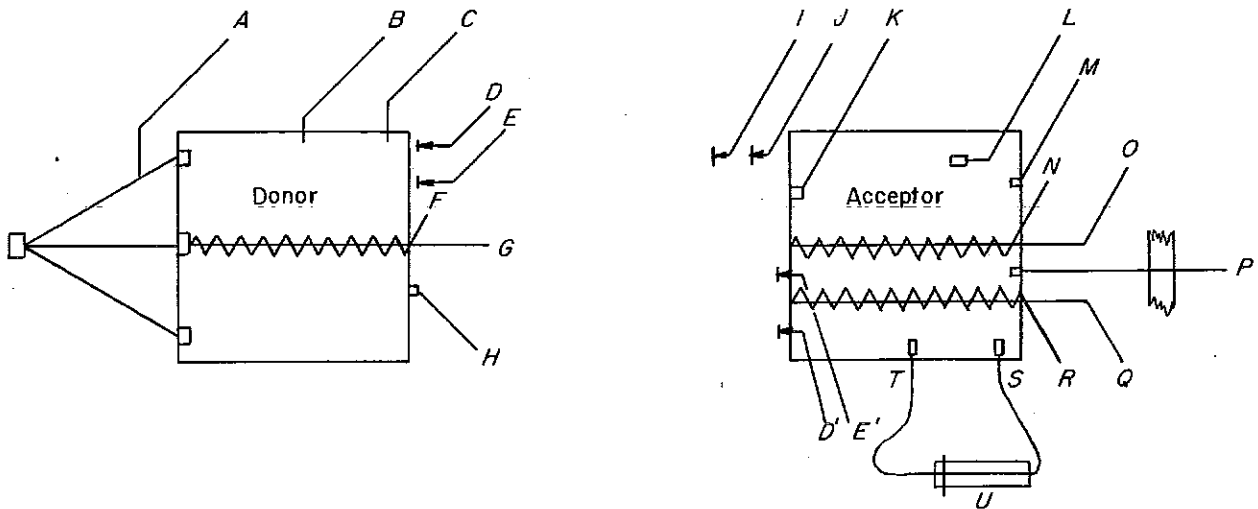

A	Primacord stub	H	Pressure gage	O	Velocity probe
B	do.	I	Foil switch	P	Tell-tale
C	do.	J	do.	Q	Velocity probe
D	Foil switch	K	Pressure gage	R	do.
E	do.	L	Primacord stub	S	D'Autrache primacord end
F	Velocity probe	M	Pressure gage	T	do.
G	do.	N	Velocity probe	U	Lead plate

FIGURE 3. - Instrumentation Applied to Charge System Used in Sympathetic Detonation Studies.

the charge in which constant current generators that were used for the continuous velocity probes were located. The underground box was protected by a metal cover weighted with sod during each shot.

Included in the truck were four oscilloscopes (three Tektronix 545-A single beam scopes and one 551 dual beam scope), all equipped with Polaroid cameras. Two Berkeley 10-mc counterchronographs were used both for time interval measurements and for determining the framing rate of a high-speed motion picture camera.

The oscilloscopes were employed predominately for velocity of detonation determinations and for determination of the pressures delivered at the downstream end of the acceptor.

The many types of instrumentation applied to the charges are shown in figure 3; however, no single shot included all this variety as one type was frequently interchanged with another to provide as much information as possible. Almost all of the shots used one or more continuous velocity probes and a pressure indicator gage in the acceptor as well as the D'Autrache velocity cord and an off-end telltale to be described later.

Synchronization of the oscilloscope sweeps with the explosive event was accomplished by electrical switches in or on the charges. Following common practice in explosive studies, the ionization accompanying detonation provided

precise switching for the instrumentation (1) sometimes one of the initiator Primacord lines, fig. 3, line A is used; frequently, however, Primacord stubs were employed as represented by lines B, C, and L; typically B and C are start and stop counter-chronograph switches with C also used for scope sweeps. Primacord-stub line L was, in all instances, used to synchronize the scope associated with pressure gage M.

Velocity of Detonation

Three coaxial (both ionization and pressure actuated) continuous-velocity probes are shown but only two were used on any given shot and one of these was always a probe O or N to indicate the presence of a detonation on the axis of the acceptor and its velocity. The continuous probe is analogous to a slide wire resistor, where the reaction either collapses a thin-wall aluminum tube onto an insulated resistance wire threaded through the tube or the ionization accompanying the detonation causes a short between an insulated wire and a core that may be either the aluminum tube or a separate conductor. If a constant current is maintained in the resistance circuit, the potential across the unaffected portion of the wire is proportional to the position of the detonation at any time. Displayed on an oscilloscope, a slope at any point on the voltage-time trace represents the instantaneous velocity. The ionization probes are represented as F, N, and R and the pressure-sensitive probes are G, O, and Q. Since the donor was well-boostered AN-FO, relatively few measurements were made on it, and it was found that the axial and off-axis probes in the acceptor provided results that exhibited the least ambiguity and were most easily interpreted. Because it is characteristic of detonations that are nonideal (for instance, AN under marginal initiation conditions) to provide erratic ionization, the collapsing probe in the acceptor was more satisfactory than the ionization probe.

The Primacord stub, L, in which an ionization probe was installed, the D'Autriche lines, T and S, and the telltale stub, P had nonelectric caps attached to facilitate initiation of the Primacord. This was not necessary for stubs B and C, introduced into the AN-FO donors.

Pressure Gages on Donors and Acceptors

Two pressure gage circuits were available; one gage (using one circuit) was always located at the downstream end of the acceptor at M to indicate the presence of a detonation and, in some instances, the other was used at either position H or K. The gage consists of a resistive element imbedded in a polyethylene mount. The dynamic resistance is determined by sensing the voltage across a component of the network that was provided at the charge to match the gage resistance to the line. The gage indicates approximate peak pressures delivered to the gage in the range from a few to more than seventy-five kilobars--a kilobar is approximately equal to 1,000 atmospheres.

Foil Switches

Foil switches actuated by fragments or shock waves, were used at various locations between the donor and acceptor charges; the time difference between

the arrival of the waves and/or fragments at two points was determined by counter-chronograph. Switches E and D were used in an attempt to determine the curvature of the wave front at the donor end; E' and D' were similarly employed at the acceptor face, and I and J were used to measure fragment or shock wave velocity.

Nonelectric Methods

Additional means of determining the occurrence of detonation in the acceptors included the D'Autriche method (10) for determination of velocities of detonation shown as U and telltale lengths of Primacord, P (fig. 3). The D'Autriche method uses an open loop of Primacord whose ends, with nonelectric caps attached, are inserted into the charge, T and S; the Primacord is then attached to a lead plate with the midpoint of the loop located near one end of the plate. The assembly is buried for protection against the blast. Since the end, T, is initiated ahead of the end, S; the detonation waves in each leg will collide at some point removed from the cord midpoint on plate, U. From the spacing between T and S, the velocity of the Primacord, and the distance between the cord midpoint and point of collision of the detonation waves, the velocity can then be calculated.

The telltale, P, is similar to one leg of the D'Autriche loop; however, the end having the nonelectric cap attached is inserted into the downstream end of the acceptor and the Primacord is passed transversely over a lead plate. Again, the system is buried for protection against blast and fragments. The plate is dented if the Primacord is initiated.

Post-shot inspection of the charge site offered supporting evidence for assessing the outcome of each shot. Craters were examined, and the presence of unconsumed prills were noted; however, with large donors and with charge separations of only a few diameters, the craters overlapped appreciably. In widely separated donor-acceptor shots involving only AN acceptors, thinly scattered prills were frequently found as a result of the failure of the reaction to develop until after much of the acceptor had been traversed by the reaction wave.

Photography

Full coverage of the shots was obtained with 35-mm black and white and color pictures and 16-mm motion pictures. Additionally, a Dynafax⁷ camera (fig. 4) was employed for high-speed sequences of some of the shots. This camera is capable of taking 224 frames as fast as 26,000 frames per second, although, mostly, a speed of 20,000 frames per second was chosen. A blast-resistant housing was fabricated, having a 1-inch-thick glass window, that permitted use of the camera as close as 100 feet to the shot, but it was generally placed at greater distances, as also shown in figure 4. The camera is of the nonsynchronous type, that is, continuously running; to photograph the shot it was necessary only to open the shutter by a solenoid control a few seconds before the shot time. The speed was preset by a variable

⁷Product of Beckman & Whitley, San Carlos, Calif. The trade name is used for identification only and endorsement by the Bureau is not implied.

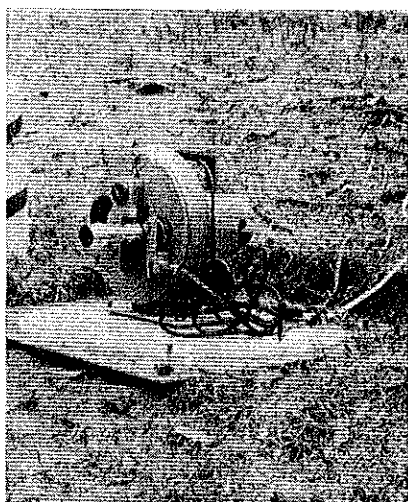

A



B

FIGURE 4. - Camera With Barricade Removed and Its Placement for Typical Shot.

transformer, using one of the counter-chronographs to measure the period from a pulse signal supplied by the rotating mirror in the camera.

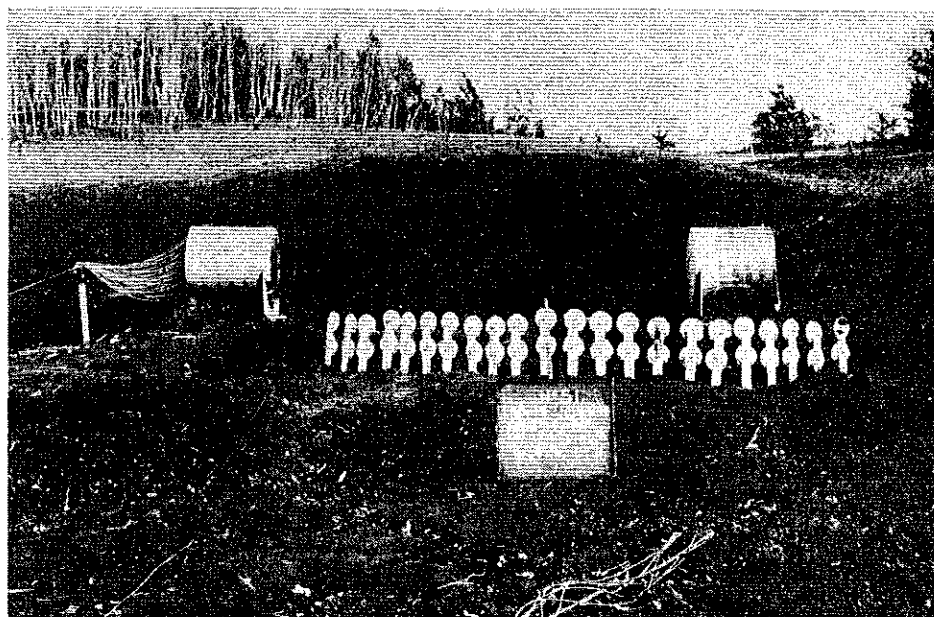

FIGURE 5. - Bank of Flashbulbs Used to Provide Supplemental Lighting for Dynafax Camera.

During early attempts to use the Dynafax camera, only film with a slow emulsion was available, and attempts were made to supplement the lighting with 44 No. 3 flashbulbs. These were series wired and synchronized to the shot by using the long Primacord firing line; the lamp arrangement is shown in figure 5. Additional capacitance was installed in the firing unit to minimize the lag in time to peak luminosity. Despite

these measures, the supplemental flash lighting did not noticeably increase picture quality. Faster film, including color, was obtained, and a decided improvement in photographic quality was realized.

Blast Pressure

Four gages, designed to determine pressure-time histories from large-scale explosive tests, were obtained from the Ballistic Research Laboratories (BRL). The gages are self recording, mechanically actuated, and require only an electrical signal a few seconds ahead of shot time to synchronize the gage to the shot. They contain a diaphragm sensor with a stylus that scratches a trace on a negator spring, employed both as motor drive and recording tape. The pressure trace, a baseline, and a 50-cps timing trace provided by an electromechanical oscillator are simultaneously recorded for use in pressure-record analyses; the pressure gage and a typical record are shown in figure 6. The gages are prepared before the shot, buried in the ground with the orifice plate at ground level, and then armed manually.

The deflection-time traces are converted to real time points by a microscope having a telecomputing readout head for x and y measurements which in turn are recorded by an automatic typewriter and paper-punch system. These data are combined with the calibration data and the final pressure-time curve is plotted automatically. The accuracy of the system is ± 5 percent when the blast lasts longer than 15 milliseconds, as it did in these shots.

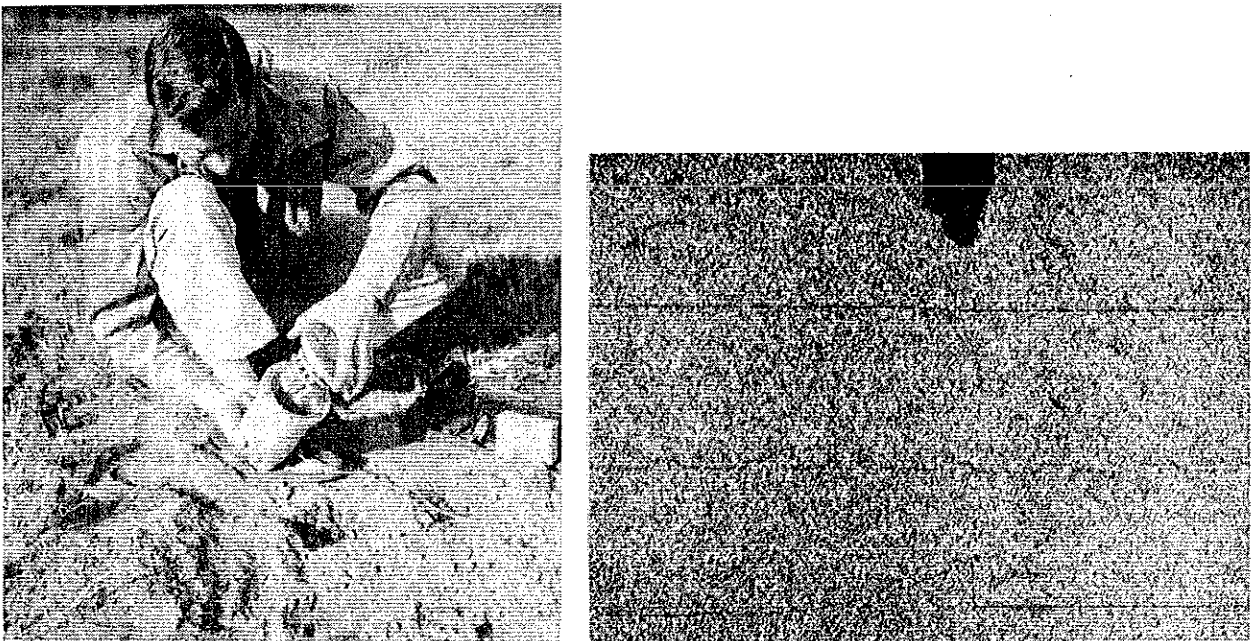

A

B

FIGURE 6. - (A) BRL Self-Recording Pressure Gage Separated From Case. (B) Gage Record, Magnified 10 X, Showing Top-Base Line, Center-50 cps Timing Wave and Lower-Pressure Wave; Increasing Time Is From Right to Left.

Most frequently, three gages were used at distances from the charges ranging from less than 100 feet to about 250 feet. The gages were located both off the downstream end and broadside to the charge axis.

Safety Precautions

Many steps were taken to isolate the long instrument lines extending to the charges from the electrical equipment in the truck. The 10 coaxial lines and the power and control line, having 12 pairs of conductors, were unbroken lengths of cable that terminated in male plugs in a junction box on the operating panel in the truck. Two sets of mating jacks were mounted in a Lucite panel; one set was connected to the instruments, the other was inert to provide a floating shunt for each line. Thus, at a glance, the positions of the plugs were readily determined. When the detonator was being attached, all lines were in the shunted safety position, and the terminal box was closed with a padlocked transparent cover. The firing line could only be energized by a key switch in series with separate arm and fire switches. One member of the two-man team, who installed the electric blasting cap on the long Primacord line, carried both keys.

A closed-circuit television system was employed for surveillance of the charge site after the area was cleared. The transistorized TV camera was mounted in a waterproof and blastproof housing and was located on a platform overlooking the charge about 100 yards away. The field of view included an area that generally encompassed the tree line on the rim of the bowl. The monitor was adjacent to the firing control panel and under continuous observation after all personnel had been evacuated.

Guards equipped with transistorized walkie-talkies occupied remote vantage points several hundred yards from the site fifteen minutes or more before the anticipated shot time. These points and one about 250 yards away on a nearby hilltop were in communication with the base radio station in the instrument truck during instrument checkout. Security of the site was confirmed during the early phase of the last minute of the countdown; the only holds necessary were a few caused by low-flying aircraft. A radio-equipped hilltop observation site was used for photographing the explosion and the final seconds of the countdown were used to synchronize the cameras with the event.

Materials

Samples were taken of the AN and AN-FO prills used in the acceptors for most of the 60 shots in the series. A few samples were taken of the AN-FO donor material. Prill size analyses were made using the U.S. standard sieve series with 10-, 12-, 14-, 16-, 18-, and 20-mesh screens. With most samples, 80 percent of the prills passed through mesh 10 (2.00 mm) and were retained on 12 (1.68 mm). An average of 0.7 percent (and a maximum not exceeding 3 percent passed through mesh 20 (0.84 mm) with the exception of samples from shots 2, 28, and 30; where the amounts passing 20 were 13.8, 11.2, and 4.6 percent, respectively; the latter two were samples of shots made at elevated temperatures (the material in one other hot shot had a normal amount of fines); samples for 1, 17, 23, 29, and 41 were not taken. Any effect of the increased

proportion of fines, such as an increase in sensitivity, was not discernible among the relatively few shots that were made in the series involving elevated temperatures.

Moisture analyses were made on the AN prills using a method in which 20-gram samples of the coarsest materials (that is, 2 mm) were heated over activated alumina at 50° C and 5-mm-Hg pressure for 72 hours. The AN-FO moisture content was determined by carbon tetrachloride distillation, using 100-gram samples of the coarsest prills and refluxing for 6 hours.

Analyses for moisture content showed a range from 0.01 to 0.09 percent of water; the AN that had been heated exhibited the lowest percentages, from 0.01 to 0.02 percent. Again, no effects on sensitivity can be related to these moisture levels.

RESULTS

The up-and-down results are shown in figures 7, 8, 9, and 10 for series I and II; III, IV, and V; VI and VII; and VIII, IX, and X, respectively.

The separation distance chosen for the first trial in series I was 40 inches, or one-charge diameter. This guess--which subsequently was found to be a poor one--was based on experience with small-diameter charges where failures to propagate are frequently observed with quite small gaps between

Series I

Donor: 40-by 40-inch AN-FO
 Donor end: polyethylene-tape
 Acceptor: 40-by 40-inch AN
 Temperature: Ambient

Gap	Shot No.	1	2	7	13	16	19	20	29	31	35	46	50	54	58
40"		Y		Y*											
53					Y										
70			N**			Y									
92							Y								
121								Y		Y		Y			
160									N	N		Y		N	
210														N	

S₅₀ = 149-inches

**Erroneously interpreted as negative

* 40-inches above grade

Series II

Donor: 40-by 40-inch AN-FO
 Donor end: Metal
 Acceptor: 40-by 40-inch AN
 Temperature: Ambient

Gap	Shot No.	3	4	5	6	8	11	14	33	49	51	53
70"		Y										
92												
121			Y									
160				Y				Y				
210				Y		N		Y		Y		
278					N				N		N	

S₅₀ = 226-Inches

FIGURE 7. - Up-and-Down Results, Series I and II. Y = acceptor initiated; N = acceptor failed to initiate.

Series III

Donor: 20- by 20- inch AN-FO	Gap \ Shot	9	10	12	15	18	32	
Donor end: Metal	No.							
Acceptor: 40- by 40- inch AN	80"				Y		Y	$S_{50} = 100\text{-inches}$
Temperature: Ambient	105	Y		N		N		
	139		N					

Series IV

Donor: 40- by 40- inch AN-FO	Gap \ Shot	17	23	27	47	48	60	
Donor end: Metal	No.							
Acceptor: 40- by 40- inch AN-FO	278"	Y						
Temperature: Ambient	366		Y					
	483			Y		Y		
	636				N		Y	$S_{50} = 636\text{-inches}$

Series V

Donor: 40- by 40- inch AN-FO	Gap \ Shot	22	25	28	30	41	
Donor end: Metal	No.						
Acceptor: 40- by 40- inch AN	210"		Y				
Temperature: 180°F	278	N		Y		Y	$S_{50} = 278\text{-inches}$
	366				N		

FIGURE 8. - Up-and-Down Results, Series III, IV, and V. Y = acceptor initiated; N = acceptor failed to initiate.

charges. Double gap increments in a series were sometimes employed in an attempt to bracket the 50-percent point with a minimum number of trials. The second shot was incorrectly interpreted as being negative because of the unreacted prills that were found near the crater after the shot and because the D'Autriche loop failed to yield a readable mark. Subsequently, both the presence of the unreacted acceptor material (in small amounts) and the erratic behavior of the D'Autriche loop could be related to the slow buildup of detonation, particularly at the periphery of the acceptor, with the blast dispersing prills from the periphery of the charge. When true failures were obtained, large quantities of prills were found (fig. 2) together with large pieces of the container; frequently, the end plate of plywood was recovered intact; at the same time, no crater was found at the site of the acceptor. However, error in interpreting the second trial resulted in several unnecessary shots.

Distance (S_{50}) at which initiation of the acceptors is expected to occur 50 percent of the time is indicated on the figures showing the up-and-down series and, except for series VI and X, is summarized in table 2 together with the K factors derived from the equation given earlier. Series VI was

Series VI

Donor: 10- by 10-inch AN-FO	Shot Gap\No.	21	24	26	34	40
Donor end: Metal	10"					N
Acceptor: 40- by 40-inch AN	13.2					
Temperature: Ambient	17.4					
	23					N
	30.2					N
	40					N
	53					N

Series VII

Donor: 40- by 40-inch AN-FO	Shot Gap\No.	37	39	42	45	56
Donor end: polyethylene-tape	160"	Y			Y	
Acceptor: 40- by 40-inch AN-FO	210			N	Y	S ₅₀ = 210-inches
Temperature: Ambient	278					
	366					N

FIGURE 9. - Up-and-Down Results, Series VI and VII. Y = acceptor initiated; N = acceptor failed to initiate.

terminated after a shot at only one-charge diameter failed to initiate the acceptor. As 10 inches is near the critical diameter for the raw AN used, further attempts were deemed unrewarding. Series X consisted of a single exploratory shot to demonstrate the effectiveness of barricades in reducing separating distances. The barricade consisted of a wall of sandwich construction in which two 4-foot by 8-foot by 3/4-inch plywood sheets, separated by 12 inches, were filled with the sandy subsoil at the site. A separation distance of 80 inches was chosen; this is one-half the distance at which initiations always occurred with similar charges (series II). This charge arrangement is shown schematically in figure 11. That a failure occurred in this shot is strong evidence for the efficacy of barricades in preventing sympathetic detonation.

None of the series was extensive enough to accurately determine the separation distances. Several S₅₀ values are suspect because they are based on only a few shots; this is particularly so in the instance of the metal-end acceptors, where only two trials were made (series IX). However, this series was merely an attempt to explore the effect of minimal shielding of the acceptor charge. The charge separation for the initial shot was a matter of much discussion but it was guessed that the metal end on the acceptor might neutralize the increased effectiveness of a metal-ended donor enough to yield results comparable to those in series I. The results appear to support this conclusion.

Series VIII

Donor: 20- by 20-inch AN-FO
 Donor end: polyethylene-tape
 Acceptor: 40- by 40-inch AN
 Temperature: Ambient

	Shot	36	38	43	44	57	
Gap	No.						
22"			Y				
26				Y	Y		S ₅₀ = 30-inches
35		N			N		

Series IX

Donor: 40- by 40-inch AN-FO
 Donor end: Metal
 Acceptor: 40- by 40-inch AN, metal end
 Temperature: Ambient

	Shot	52	55	
Gap	No.			
160"		Y		
210			N	S ₅₀ = 185-inches

Series X (Sand Barrier)

Donor: 40- by 40-inch AN-FO
 Donor end: Metal
 Acceptor: 40- by 40-inch AN
 Temperature: Ambient

	Shot	59
Gap	No.	
80"		N

FIGURE 10. - Up-and-Down Results, Series VIII, IX, and X. Y = acceptor initiated; N = acceptor failed to initiate.

TABLE 2. - Estimated distances determined for 50 percent initiations with corresponding K factors

Series	Donor size,	Donor end	Acceptor material ¹	Temperature	S ₅₀ , inches	K ₅₀ , ft/lbs ^{1/3}
I.....	40 x 40	PE ¹	AN.....	Ambient....	149	1.08
II.....	40 x 40	Metal.....	AN.....	...do.....	226	1.64
III.....	20 x 20	Metal.....	AN.....	...do.....	100	1.43
IV.....	40 x 40	Metal.....	AN-FO.....	...do.....	636	4.60
V.....	40 x 40	Metal.....	AN.....	180° F.....	278	2.02
VII.....	40 x 40	PE.....	AN-FO.....	Ambient....	210	1.52
VIII.....	20 x 20	PE.....	AN.....	...do.....	30	0.43
IX.....	40 x 40	Metal.....	AN, metal end..	...do.....	185	1.35

¹PE = Polyethylene sheet; AN = ammonium nitrate; AN-FO = ammonium nitrate-fuel oil.

In this program, the booster system gave nearly plane wave initiation of the donor, minimizing but not eliminating edge effects. The validity of the scaling law associated with this model was only poorly supported by the results. Since the weight varies with the cube of the linear dimension for the charges employed, the separation-weight equation can be rewritten as

$$S = KW^{1/3} = KL.$$

Thus, the 20- by 20-inch charges should have had separation distances half those of the 40- by 40-inch charges. This result is nearly obtained with metal-ended donors, 226 inches in series II and 100 inches in series III, but a five-fold ratio of distances was obtained in the two soft-end series (I and VIII) and, as described above, the 10-inch series (VI) failed to give useable data.

Instrumental Data Analyses

The data acquired from electronic instrumentation were qualitatively analyzed on the site for guidance in interpretation of results in terms of positive or negative initiation of the acceptor. These data were later reduced at the Explosives Research Center in Pittsburgh with the exception of the blast pressure gage records which were returned to BRL for reduction.

Typical of the oscillograms obtained for the detonation velocity and off-end pressure records are those shown in figure 12. In figure 12(A), shot 5, the detonation velocity in the 40-inch AN-FO donor is determined to be about 5.3 mm/ μ sec for the final one-third of the charge; whereas, the initial velocity in the first quarter of the charge averages about 3.7 mm/ μ sec.

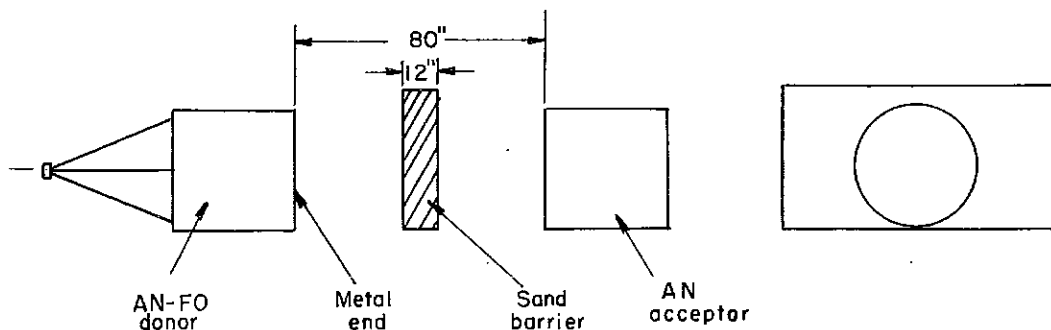
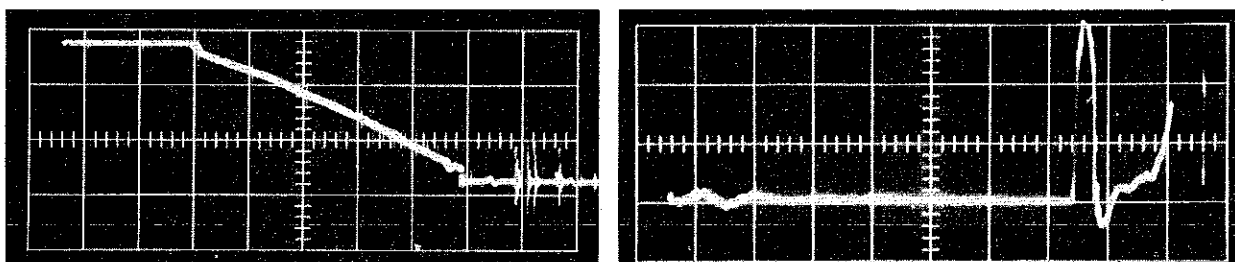

FIGURE 11. - Schematic of Charge-Sand Barrier Arrangement (Shot 59).



A

B

FIGURE 12. - Typical Oscillograms (Shot 5) From Which Velocity and Pressure Are Obtained. (A) AN-FO donor velocity-time increases from left to right (50 μ sec/div); distance from initiated end is from top to bottom. (B) AN acceptor pressure trace-time increases from left to right (10 μ sec/div); pulse shown at about 70 μ sec is peak pressure delivered to the gage.

The pressure pulse on the downstream end of an AN acceptor is shown in figure 12(B). The oscilloscope sweep rate was 10 $\mu\text{sec}/\text{division}$ and the peak pressure delivered to the gage was about 25 kilobars; a pressure of this magnitude is typical of that expected from a good detonation in AN. Synchronization was provided by using an ionization switch in a Primacord stub 25 cm ahead of the gage. Since the elapsed time from sweep start to pulse is about 70 μsec , an average detonation velocity of 3.6 mm/ μsec is indicated and is in agreement with the result obtained from the continuous probe.

Pressure records obtained from the shots in each series were analyzed for peak pressure. Those delivered at the end of the donor ranged from 50 to 70 kilobars, and the amplitude did not appear to be related to either size or end material; whereas, acceptor pressures at the downstream end ranged from <10 to >50 kilobars for the AN and AN-FO. Most of those >30 kilobars resulted from the AN-FO shots.

Typical velocity of detonation records for AN-FO and AN acceptors are shown in figure 13, representing a high-velocity detonation in AN-FO (shot 27), a low-velocity detonation in AN (shot 20), and an AN failure (shot 36). Since the synchronizing signal was obtained from the donor charge, the particle and/or shock transit time across the gap can be determined. For example, in the pressure-sensitive probe record of figure 13(A) (shot 27), the time interval to the point of change of slope, where the sweep is 500 $\mu\text{sec}/\text{division}$, is about 3,600 μsec . This represents an average particle velocity, across the gap of 483 inches, of about 3.4 mm/ μsec . A high-velocity detonation is indicated but actually the terminal velocity for the AN-FO acceptor (5.6 mm/ μsec) was determined from a simultaneously recorded trace, on another oscilloscope channel, in which five times expansion of the trace (100 $\mu\text{sec}/\text{div}$) was permitted by setting in a finite sweep delay of 3,000 μsec . A low-velocity detonation is shown in figure 13(B) for AN (shot 20) in which a 40-inch donor and a gap separation of 121 inches were used. Here, the sweep time is 200 $\mu\text{sec}/\text{division}$, and the pressure-sensitive probe indicated a uniform velocity of detonation in the AN of 1.34 mm/ μsec after a runup time of about 100 μsec over about 2 inches in the charge. A delay of 850 μsec over the 121-inch separation represents an average particle and/or shock velocity of 3.6 mm/ μsec . An ionization probe record is shown in figure 13(C) (shot 36) in which the sweep is 200 $\mu\text{sec}/\text{division}$; a failure is indicated by the decaying velocity and the lack of probe response beyond an interval of about 800 μsec .

Table 3 presents detonation velocity results from use of continuous probes (both ionization and pressure sensitive) on the donor axis and rates determined chronographically from the transit time for a 50-cm interval on the periphery (downstream end) of the donor charge. Higher rates were obtained as the charge size increased. The discrepancy between the rates on the axis and the periphery is probably due to edge effects. Thus, the material on the axis of the charge detonates in a more ideal manner than do the outer portions, probably owing to the long reaction zone in the detonation.

A summary of the results of the entire series, including terminal detonation rates from the axial and off-axis probes as well as those from the

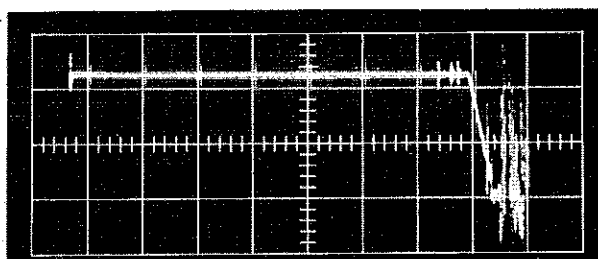

A

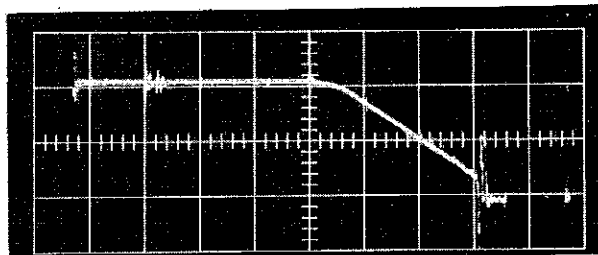

B

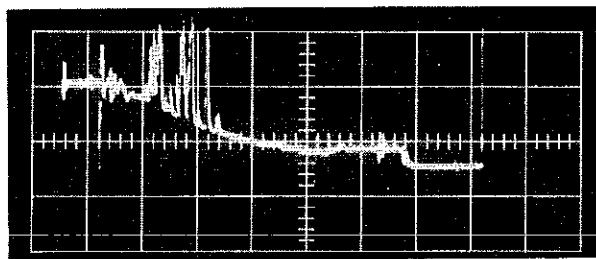

C

FIGURE 13. - Oscillograms of Velocity Records Produced in Acceptors: (A) AN-FO Showing High-Velocity Detonation (sweep $500 \mu\text{sec}/\text{div}$); (B) AN Showing a Low-Velocity Detonation (sweep $200 \mu\text{sec}/\text{div}$); and (C) a Failure in AN ($200 \mu\text{sec}/\text{div}$).

D'Autriche, are given in table 4. The axial velocities obtained for the raw AN at ambient temperature were dependent on the donor size and were influenced by the donor-end material, for instance, use of 20-inch-PE-end donors resulted in an average detonation velocity of $1.3 \text{ mm}/\mu\text{sec}$, and the highest velocities resulted from using the 40-inch metal-end donor where the average rate was $2.7 \text{ mm}/\mu\text{sec}$.

Only 40-inch donors were used with AN-FO acceptors, and the donor-end material exhibited little effect on the rates when the AN-FO detonated--the average was about $5.2 \text{ mm}/\mu\text{sec}$ for the metal-end donor and 5.1 for the PE-end donor as measured on the charge axis. Again, the D'Autriche rates were lower, and the scatter was more pronounced.

TABLE 3. - Velocities of detonation determined for AN-FO donors

Shot	End	Size, inches	Velocity of detonation, ¹ mm/ μ sec	
			Continuous probe, axis	Counter-chronograph, periphery
34.....	Metal.....	10 x 10	4.6	4.1
40.....	Metal.....	10 x 10	-	3.2
59A.....	Metal.....	10 x 10	3.1	2.4
Average.		-	3.9	3.3
32.....	Metal.....	20 x 20	4.6	4.1
38.....	PE ²	20 x 20	-	3.3
43.....	PE.....	20 x 20	-	3.2
44.....	PE.....	20 x 20	4.3	3.9
Average.		-	4.5	3.6
5.....	Metal.....	40 x 40	5.3	-
30.....	Metal.....	40 x 40	-	4.3
33.....	Metal.....	40 x 40	-	4.6
41.....	Metal.....	40 x 40	-	3.9
49.....	Metal.....	40 x 40	-	4.3
60.....	Metal.....	40 x 40	5.5	4.2
29.....	PE.....	40 x 40	-	4.3
31.....	PE.....	40 x 40	-	4.5
37.....	PE.....	40 x 40	-	4.3
39.....	PE.....	40 x 40	-	3.9
Average.		-	5.4	4.3

¹ Downstream half of the charge.

² PE = Polyethylene sheet.

Temperatures of the acceptors are given in table 4, the ambient ranging from 50° F to 78° F with an average of 60° F. The temperature of the heated AN ranged from 179° to 190° F, the average being 183° F.

The shock and/or fragment-velocities across the gap between the donors and acceptors were determined by analysis of the oscillograms and the Dynafax photographs. A typical high-speed photographic sequence is shown in figure 14 (shot 32); a 20- by 20-inch metal-end donor was used. Two photographic strips are shown in which the interframe time is 50 μ sec (adjacent frames on each strip are 100 μ sec apart). The sequence clearly shows the shock transversing the gap and the breakthrough of the metal fragments about 200 μ sec after the shock wave emerged from the donor. A plot of the velocities is shown in figure 15 in which reasonable agreement between the two methods is indicated. Average velocities (\bar{V}_g) are taken from the slope of the curve and range from a maximum of 5.3 mm/ μ sec to less than 4.0 mm/ μ sec for a standoff distance of 100 inches.

Fragment and shock velocities were also determined using foil switches. A plot of the fragment velocity versus distance from the donor is presented in figure 16. A peak velocity, based on an average velocity across a 20-cm increment is indicated at a distance of 30 cm from the donor end.

TABLE 4. - Summary of initiation result and acceptor detonation velocities

Shot	Donor		Gap, inches	Acceptor ¹		Result ²	Acceptor detonation velocity, mm/ μ sec		
	Size, inches	End ³		Material ³	Temperature, ° F		Axis	Off-axis	D'Autriche
1.....	40	PE	40	AN	-	Y	-	-	3.8
2.....	40	PE	70	AN	78	N	-	-	-
3.....	40	M	70	AN	65	Y	3.5	-	3.3
4.....	40	M	121	AN	69	Y	4.1	-	3.1
5.....	40	M	160	AN	63	Y	3.5	-	-
6.....	40	M	210	AN	69	Y	2.5	-	-
7.....	40	PE	40	AN	62	Y	3.6	-	-
8.....	40	M	278	AN	64	N	-	-	-
9.....	20	M	105	AN	65	Y	1.2	-	-
10.....	20	M	139	AN	62	N	-	-	-
11.....	40	M	210	AN	67	N	-	-	-
12.....	20	M	105	AN	67	N	-	-	-
13.....	40	PE	53	AN	65	Y	3.6	-	2.5
14.....	40	M	160	AN	65	Y	2.7	-	2.5
15.....	20	M	80	AN	68	Y	2.6	-	1.8
16.....	40	PE	70	AN	61	Y	3.7	-	-
17.....	40	M	278	AN-FO	64	Y	5.3	-	4.0
18.....	20	M	105	AN	52	N	-	-	-
19.....	40	PE	92	AN	61	Y	2.3	-	1.7
20.....	40	PE	121	AN	51	Y	1.8	-	-
21.....	10	M	53	AN	56	N	-	-	-
22.....	40	M	278	AN	179	N	-	-	-
23.....	40	M	366	AN-FO	57	Y	4.8	4.8	5.0
24.....	10	M	40	AN	52	N	-	-	-
25.....	40	M	210	AN	179	Y	3.3	4.0	3.1
26.....	10	M	30	AN	54	N	-	-	-
27.....	40	M	483	AN-FO	56	Y	5.6	5.3	4.2
28.....	40	M	278	AN	183	Y	1.3	1.4	-
29.....	40	PE	160	AN	59	N	-	-	-
30.....	40	M	366	AN	190	N	-	-	-
31.....	40	PE	121	AN	62	Y	1.3	-	-
32.....	20	M	80	AN	50	Y	2.2	-	1.7
33.....	40	M	210	AN	58	Y	1.3	-	1.7
34.....	10	M	23	AN	58	N	-	-	-
35.....	40	PE	160	AN	59	N	-	-	-
36.....	20	PE	35	AN	58	N	-	-	-
37.....	40	PE	160	AN-FO	58	Y	4.8	4.7	2.1
38.....	20	PE	22	AN	56	Y	1.5	1.4	-
39.....	40	PE	366	AN-FO	59	N	-	-	-
40.....	10	M	10	AN	59	N	-	-	-
41.....	40	M	278	AN	183	Y	-	1.6	-
42.....	40	PE	210	AN-FO	59	N	-	-	-
43.....	20	PE	26	AN	59	Y	1.3	1.3	-
44.....	20	PE	35	AN	57	N	-	-	-
45.....	40	PE	160	AN-FO	57	Y	5.1	4.9	4.3
46.....	40	PE	121	AN	57	Y	1.5	2.1	1.1
47.....	40	M	636	AN-FO	57	N	-	-	-
48.....	40	M	483	AN-FO	57	Y	4.9	4.9	-
49.....	40	M	278	AN	57	N	-	-	-
50.....	40	PE	160	AN	57	Y	1.7	-	1.2
51.....	40	M	210	AN	57	Y	1.4	1.6	-
52.....	40	M	160	³ AN	57	Y	3.8	-	1.5
53.....	40	M	278	AN	56	N	-	-	-
54.....	40	PE	210	³ AN	57	N	-	-	-
55.....	40	M	210	³ AN	56	N	-	-	-
56.....	40	PE	210	AN-FO	58	Y	5.5	5.5	4.3
57.....	20	PE	26	AN	58	Y	1.2	1.2	1.3
58.....	40	PE	160	AN	58	N	-	-	-
59.....	40	M	80	⁴ AN	56	N	-	-	-
60.....	40	M	636	AN-FO	57	Y	-	-	5.1

140" x 40" size used in all shots.

² PE = Polyethylene sheet; M = metal; AN = ammonium nitrate; AN-FO = ammonium nitrate--fuel oil;

Y = acceptor initiated; N = acceptor failed to initiate.

³ Metal end on acceptor.

⁴ Sand barrier.

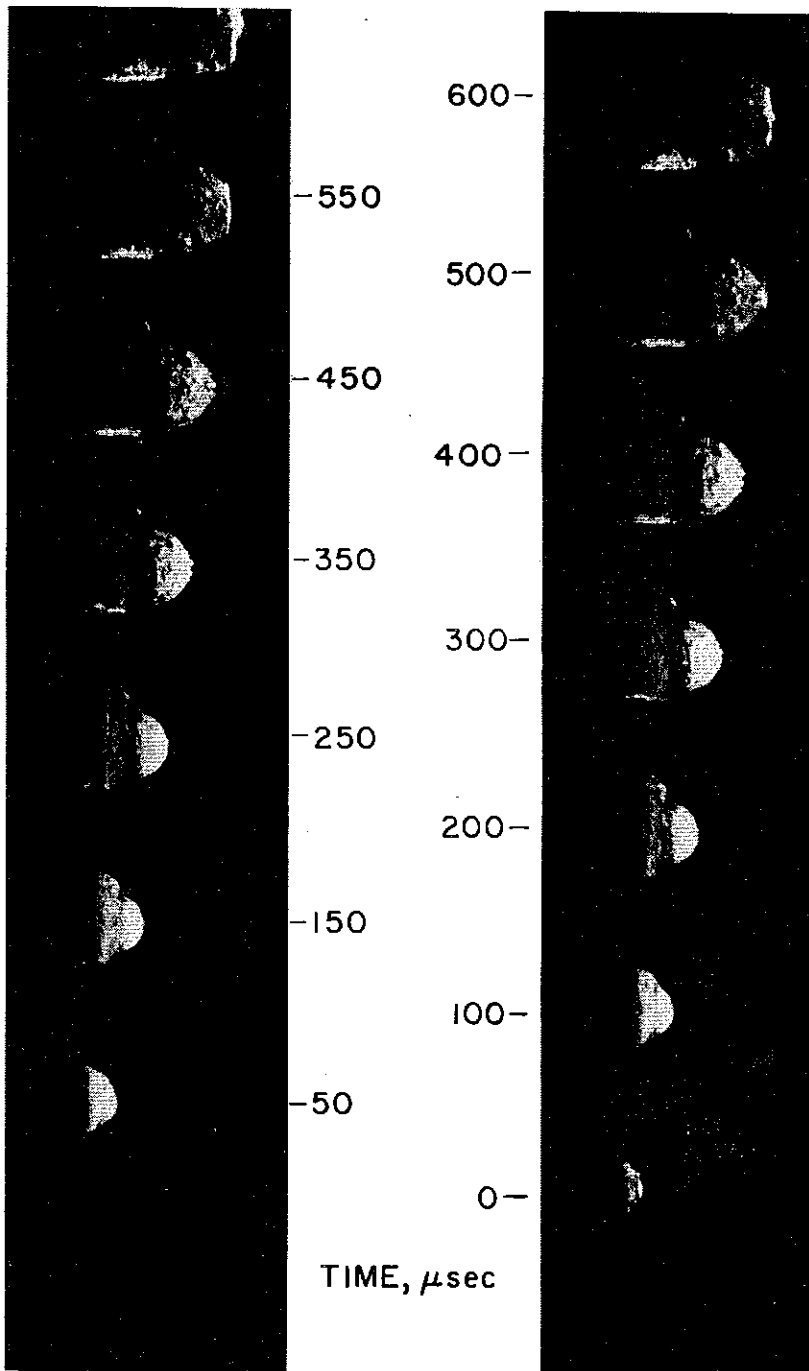

FIGURE 14. - Dynafax Sequence (Shot 32) Taken at 20,000 Frames per Second.

Peak overpressures were measured, using BRL gages for most of the shots. Obviously, when the acceptor failed to detonate, the blast pressure that was recorded was from only the AN-FO donor. However, when the acceptor detonated, the overpressure was due to the AN-FO donor plus that from the reaction in the acceptor.

The peak overpressures for the three donor sizes of AN-FO are shown in figure 17 in which the distances from the charge are normalized. The solid line in the figure is the expected overpressure from a TNT surface blast (7). Since the AN-FO data points closely fit the TNT curve, the peak pressures produced by AN-FO are essentially equivalent to that of TNT.

In those instances in which the acceptors detonated, the combined yield of the donor and acceptor was determined from the overpressure and, correcting for the AN-FO donor contribution, the yield for AN was calculated. The TNT equivalent of the AN varies from 20 to 60 percent, apparently depending on the completeness of reaction.

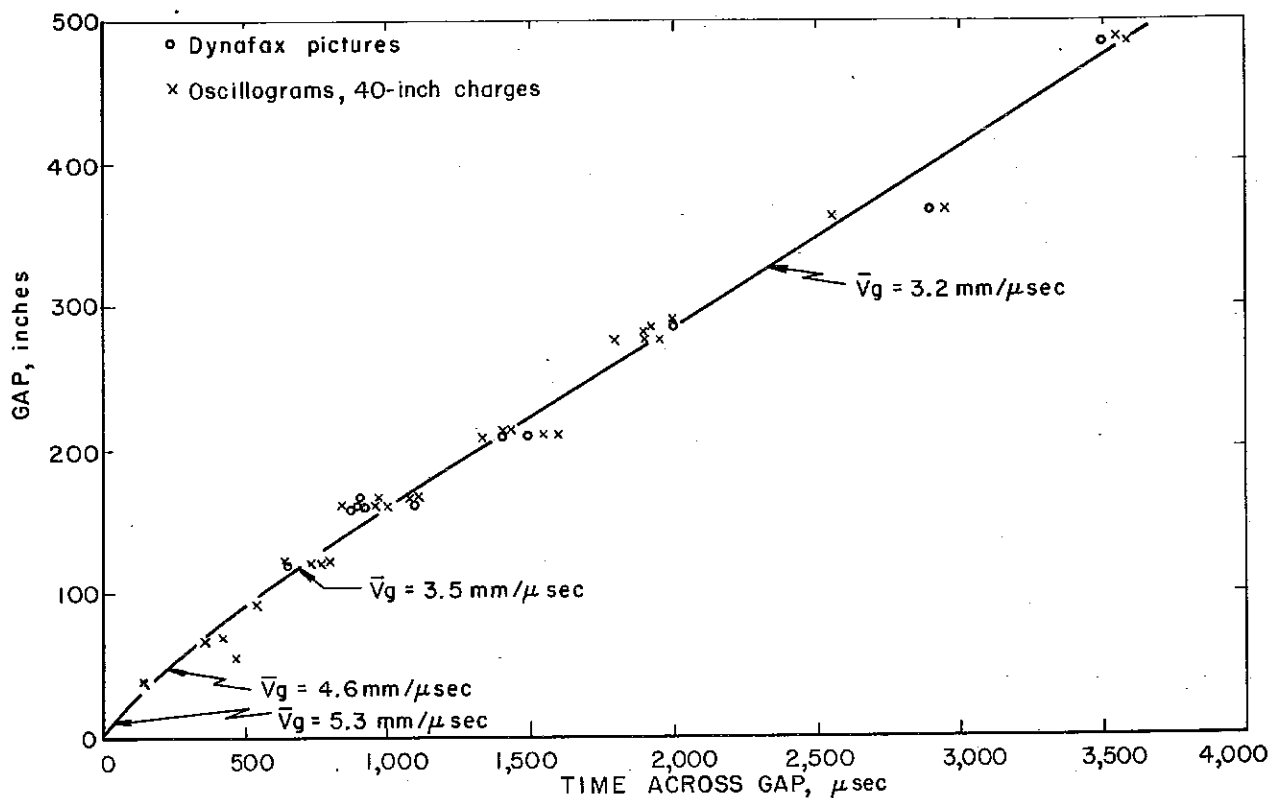

FIGURE 15. - Distance-Time Plot of Shock to Fragments Across Gaps for 40-Inch Donors.

DISCUSSION AND CONCLUSIONS

The distances across which AN or AN-FO can be initiated by an AN-FO donor are surprisingly large. The nearly 4-charge-diameter separation for the 40-by 40-inch soft-end donor and $5\frac{1}{2}$ charge-diameter separation for the metal-end donor, both for raw AN, were completely unanticipated; but perhaps the most surprising of all was initiation of one AN-FO acceptor 53 feet (nearly 16-charge diameters) away from a hard-end donor (fig. 18). Previous to this work, it was generally assumed because of small charge results that AN and even AN-FO were extremely resistant to initiation across an air gap. Practical experience in the field with small-diameter charges has been that any sizable gap between cartridges of AN or other nitrocarbonitrates generally caused failure of propagation. Also, the very low sensitivity of ammonium nitrate, as measured by the usual techniques, suggested that AN should fail to propagate across much smaller gap distances. The results obtained in this program suggest some reasons for these apparent discrepancies.

Strong evidence exists that the apparent insensitiveness of AN and AN-FO results largely from a manifestation of critical diameter effects, with these materials, particularly AN, having large critical diameters. Critical diameter is, of course, related to sensitivity in the overall sense inasmuch as it is a function of the ease with which the release of energy is initiated

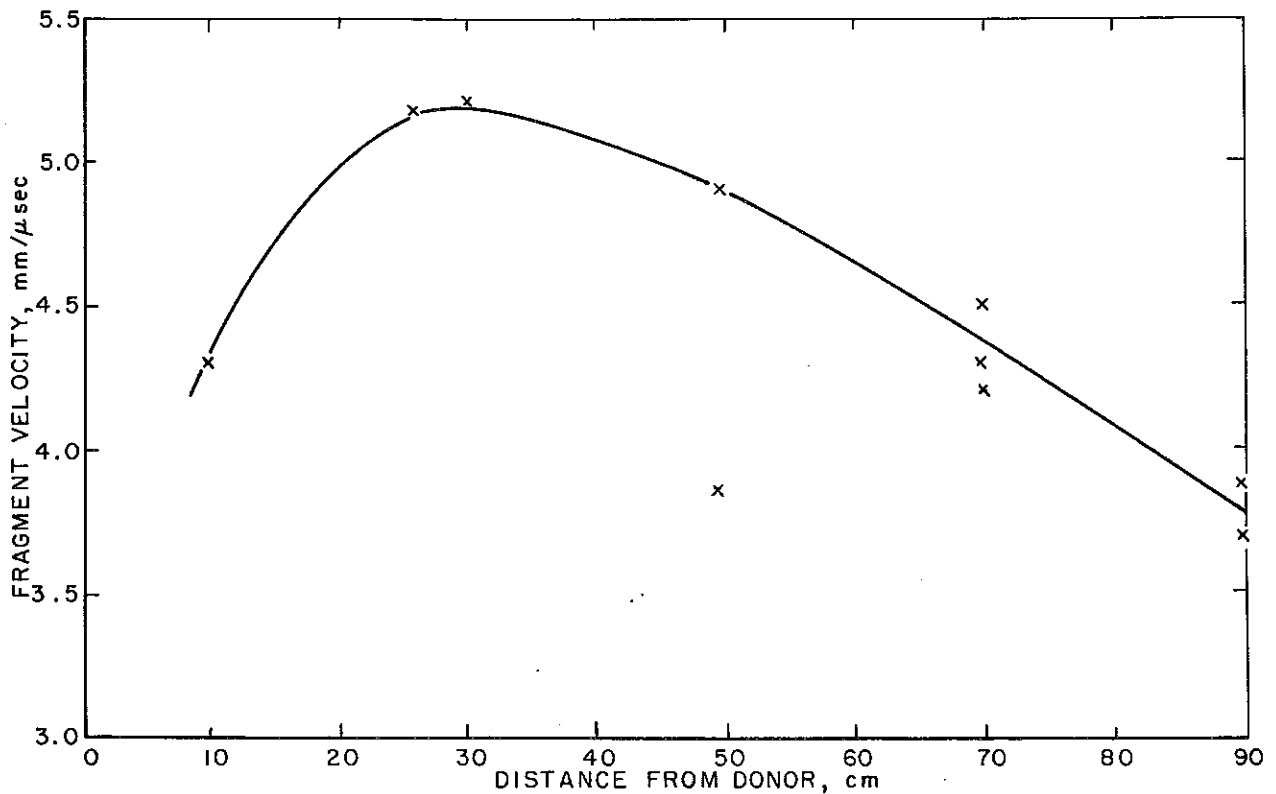

FIGURE 16. - Fragment Velocities, Near 40-Inch Metal-End Donors, Determined by Use of Foil Switches.

(activation energy), the amount of energy released per unit quantity, and its rate of release (reaction zone thickness). AN and AN-FO are less sensitive than typical dynamites and military-type explosives, but not as insensitive as is implied by the results obtained in small-scale tests. The answers lie in the ability of a marginally initiated reaction to grow to detonation. Recently, the mechanism of initiation of solid explosive charges has been rather satisfactorily elucidated in general terms, particularly with respect to growth to detonation after marginal initiation (8, 9). The effect of charge size on this growth is magnified with AN and AN-FO because reaction zone widths are probably very large, and the rate of energy release is relatively low. These two statements relate to the non-ideal detonation characteristics of AN and AN-FO; an ideal detonation represents the condition at which the material detonates at maximum velocity. A relationship between initiating pressure and charge diameter, shown schematically in figure 19, indicates that for a given temperature there is a minimum diameter below which no shock is capable of initiating detonation (critical diameter). Similarly, a minimum shock pressure is indicated for initiation of detonation at infinite charge diameters. The effect of temperature is included in the plot; a higher temperature reduces the initiating pressure at a given charge diameter, or conversely, higher charge temperature leads to a lower critical diameter.

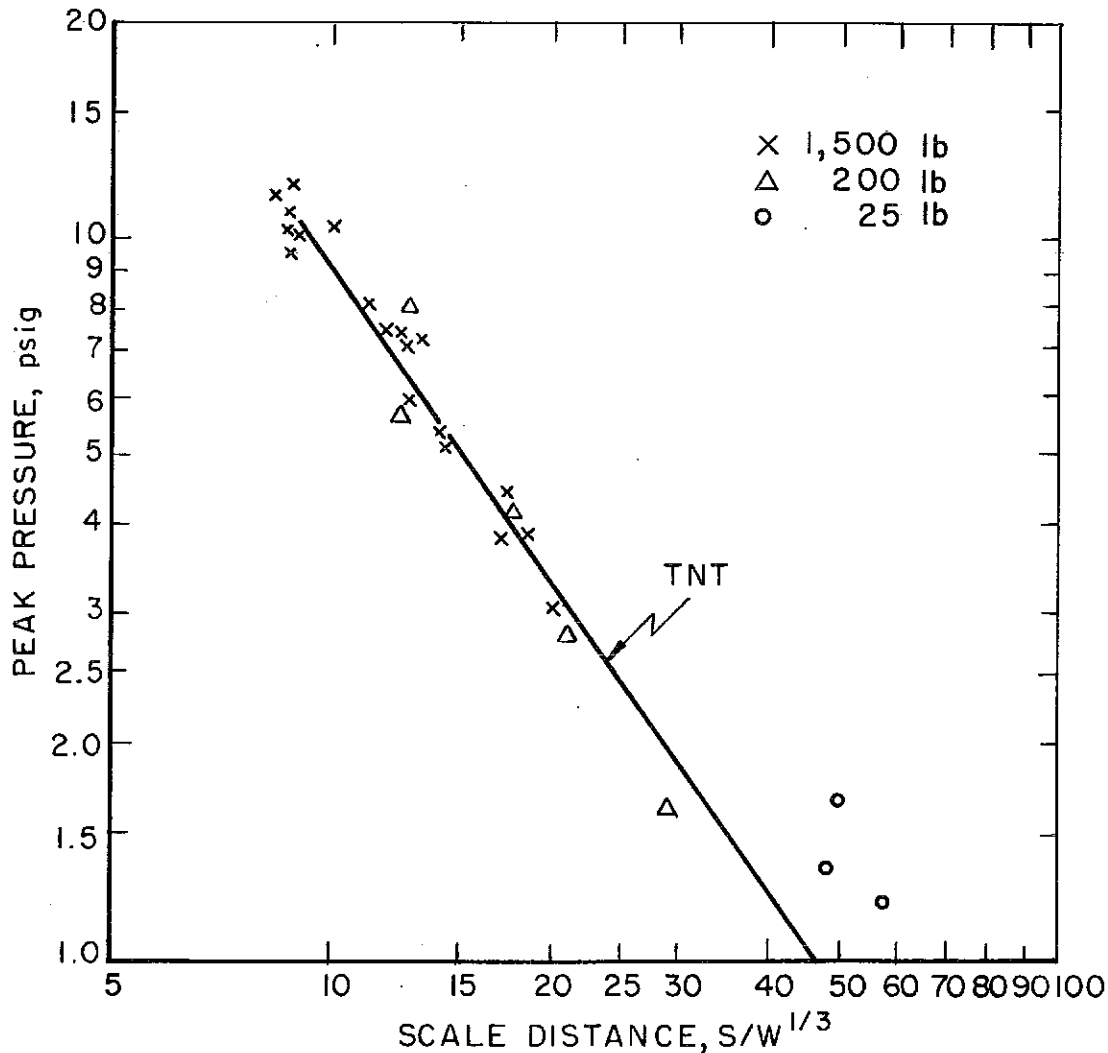

FIGURE 17. - Blast Pressures From AN-FO.

The continuous probe data obtained in this program supports this concept of growth to detonation. The axial probe records on acceptor charges that detonated show almost immediate pickup of a detonation and more or less a steady velocity through the charge. Off-axis probes showed a considerable time delay before initiation of detonation. The growth from the axis outward as the reaction proceeds through the charge is substantiated by results frequently obtained with the D'Autriche loop--only one end, most probably the downstream end of the loop, was initiated--and often neither end was initiated although the axial probe showed the presence of a continuous reaction wave having a reasonable velocity.

Another consideration suggests the reasonableness of this model. The shock wave impacting on the acceptor charge has a maximum amplitude and a maximum impulse at the charge axis. The growth of reaction along the axis should be most rapid because of symmetry where the inertia of the surrounding material provides confinement and the resulting high pressure facilitates



FIGURE 18. - Maximum Charge Separation (53 Feet) Employed in Test Series in Which a Hard-End Donor and an AN-FO Acceptor Were Used. One positive and one negative result occurred for this arrangement.

rapid decomposition. The experimental design was deliberately chosen to maximize these effects because it was felt that even the 40-inch-diameter charges might be marginal in size when modeling stores of materials that could amount to many tons. The charges were aligned on a common axis and near-plane wave initiation of the donor was employed in an attempt to simulate a core in the center of a much larger pile facing a similar core in another very large pile. Most previous work related only the size of the donor to the separation distance and did not take into consideration the potential for growth to detonation if the shock pressure can be maintained for a sufficiently long period and if there is sufficient mass in the acceptor to provide self-confinement during the growth phase.

The basic goal of the program was to establish safe separation distances, and the data presented so far have comprised only distances at which initiation is expected in 50 percent of the trials. Simple statistical considerations show that no easy solution to the problem of adequate separation distances is possible. If trials are conducted at a level that gives no initiations, a very large number of trials are required for confidence in the results. If one attempts to go from a distance for 50 percent probability of initiation to one of low probability, the standard deviation of the population and the distribution of the population must be known. The usual approach is to assume a normal distribution of results and to estimate the standard deviation; the up-and-down procedure provides a mechanism for doing this. But it must be realized that estimates so derived cannot be very precise,

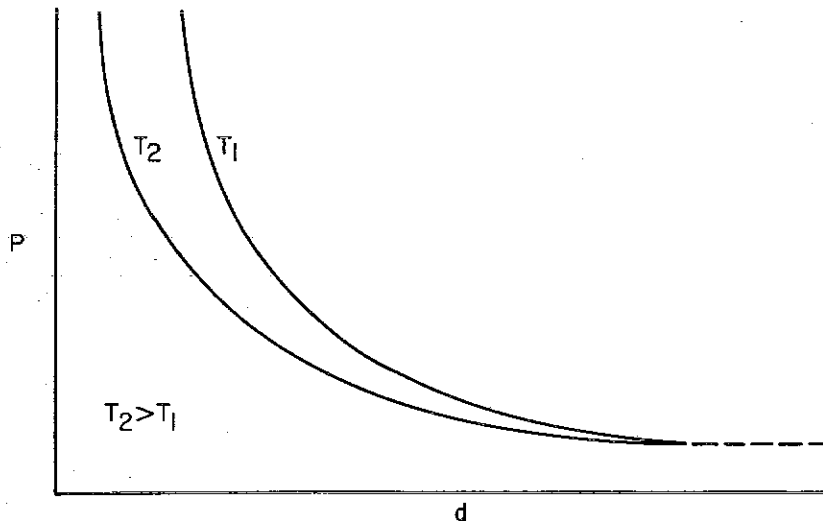

FIGURE 19. - Effects of Diameter (d) and Temperature (T) on Initiation Pressure (P).

examination of the up-and-down data gives some support. With a 2σ interval, only one level in each series had both positive and negative results, the next greater distance gave all negative results, and the next smaller distance gave all positive results.

The various tables of separation distances that are available have little in common. The American Table of Distances is the most widely accepted in this country. This table has stood the test of time but experience has largely been with barricaded magazines; the factor of 2 proposed by the table for unbarricaded magazines has not been rigorously established. K factors from the American Table of Distances for unbarricaded magazines, derived from doubling the barricaded distances, are listed in table 5 together with K factors for Nitramon⁸ and dynamite, derived from tables in the Blaster's Handbook (5) and a K factor for unbarricaded magazines from distances in the Ordnance Safety Manual (13). The duPont data for dynamite were based on 100-percent-failure distances, using dynamite donors weighing as much as 20,000 pounds but with small acceptor charges. The basis for the Ordnance Safety Manual distances is not known. In contrast, Robinson (11) suggests that the distance for sympathetic detonation is about the same as the radius of the crater produced by the donor, for which he gives the relationship $W = 4L^{2.25}$ -- where L is the radius of the crater in feet, and W is the weight in pounds. This converts to the more usual formula of $L = .54 W^{.44}$. The results of the present investigation clearly indicate the fallacy of limiting the radius of sympathetic detonation to that of the crater.

For comparison and without implying that these necessarily represent a suitable choice for determining separation distances, K factors for AN-FO and AN based on an increase of 3σ (standard deviation) over the median values are also listed in table 5. The AN value is approximately twice that for Nitramon

⁸Nitramon is a trade-marked brand of nitrocarbonitrate produced by E. I. duPont de Nemours & Co., Inc.

because the up-and-down method is deliberately chosen to be an economical means of determining the median. Appendix B gives the computation of a standard deviation using normalized up-and-down data from all of the series. The derived value of $0.05 \log_{10}$ units is in reasonable agreement with the guess of $0.06 \log_{10}$ units assumed in designing the experiment. Caution is again urged that this estimated standard deviation may be in error. However, an

examination of the up-and-down data gives some support. With a 2σ interval, only one level in each series had both positive and negative results, the next greater distance gave all negative results, and the next smaller distance gave all positive results.

separation distances and the value for AN-FO lies between that given for dynamite (Blasters' Handbook) and, for smaller quantities of explosives, in the American Table of Distances.

TABLE 5. - K factors from various sources

Charge weight, pounds	K ¹					m + 3σ ⁵	
	A.T.D. ²	NCN ³	Dynamite ³	OSM ⁴			
					AN	AN-FO	
1,000.....	7.2	1.2	5.5	11	2.3	6.4	
10,000.....	7.2	1.2	5.5	11	2.3	6.4	
30,000.....	7.2	1.2	5.5	11	2.3	6.4	

¹ From equation $S = KW^{1/3}$.

² Twice the K factor derived from the American Table of Distance to correct for unbarricaded magazines.

³ Derived from distances for 100 percent failures with unbarricaded Nitramon (NCN) and dynamite quoted in Blasters' Handbook, p. 142. (See (6).)

⁴ Derived for unbarricaded, above-ground magazines from Ordnance Safety Manual Table 1741, p. 17-61, May 15, 1958.

⁵ Median gaps found for raw AN and AN-FO with missile-producing donors increased by three standard deviations.

At the conclusion of this program it seemed clear that this investigation should be extended if a completely satisfactory table of separation distances was to be obtained. The extension of the work would include an increase in charge size for AN and AN-FO, a study of the efficacy of barricades, and a study of the sympathetic detonation of unbarricaded military explosives or dynamites. At the present time, such a program is underway and the results will be reported at a later date.

REFERENCES

1. Bowser, M. L., and F. C. Gibson. Pulse-Forming Circuitry for Explosives Research. BuMines Rept. Inv. 5985, 1962, 8 pp.
2. Brownlee, K. A., J. L. Hodges, and M. Rosenblatt. The Up-and-Down Method with Small Samples. J. Am. Stat. Assn., v. 43, 1953, p. 262.
3. Bureau of Mines, Staff. Safety Recommendations for Sensitized Ammonium Nitrate Blasting Agents. BuMines Inf. Circ. 8179, 1963, 15 pp.
4. Dixon, W. J., and F. M. Massey, Jr. Introduction to Statistical Analysis. McGraw-Hill Book Co., Inc., New York, 2d ed., 1957, 488 pp.
5. E. I. duPont de Nemours & Co., Inc. Blasters' Handbook. 14th ed., 1958, p. 142.
6. Institute of Makers of Explosives. American Table of Distances. Pamph. No. 2, rev. Sept. 30, 1955, 4 pp.
7. Kingery, C., and B. Pannill. Peak Over-Pressure vs Scaled Distance for TNT Surface Burst (Hemispherical Charges). BRL memo. rept. 1518, April 1964, p. 15.
8. Macek, Andrej. Transition from Deflagration to Detonation in Cast Explosives. J. Chem. Phys., v. 31, No. 1, July 1959, pp. 162-167.
9. _____. Sensitivity of Explosives. Chem. Rev., v. 42, 1962, pp. 41-63.
10. Munroe, C. E., and J. E. Tiffany. Physical Testing of Explosives at the Bureau of Mines Explosives Experiment Station, Bruceton, Pa. BuMines Bull. 346, 1931, pp. 64-65.
11. Robinson, G. S. Explosions--Their Anatomy and Destructiveness. McGraw-Hill Book Co., New York, 1st ed., 1944, pp. 18, 69.
12. U.S. Department of Defense. Ordnance Safety Manual. ORDM 7-224, May 15, 1958, p. 17-23.
13. _____. Ordnance Safety Manual. ORDM 7-224, May 15, 1958, table 1741, p. 17-61.

APPENDIX A.--CHRONOLOGY OF PROGRAM, 1964

June 5.--Began preliminary tests on transmission of detonation from AN-FO to AN at Spencer Chemical Co. site near Joplin, Mo.

July 2.--Meeting held in Pittsburgh to discuss preliminary results and to develop an experimental design for establishing the sympathetic detonation properties of fertilizer-grade ammonium nitrate.

August 7.--Second meeting held in Pittsburgh to finish broad outline of program of approximately 50 large-scale gap tests.

August 11.--Proposed cooperative agreement was sent to Manufacturing Chemists' Association.

August 26.--Cooperative agreement was signed by Manufacturing Chemists' Association.

August 27.--Cooperative agreement was approved by the Director, Bureau of Mines.

August 28.--Instrument truck departed from Bruceston for Ashland, Wis.

August 29.--Instrument truck and Bureau team arrived at Ashland, Wis.

August 30.--Access road, under construction, was nearly impassable; instrument truck was located on site. Instrument lines were laid.

September 1.--Road was impassable; all vehicles were towed in by bulldozer. Motor generator (new) was throwing oil and was not producing rated power.

September 2.--Fired shot 1 at 4:55 p.m.

September 3.--Fired shot 2 at 4:05 p.m.

September 4.--Two shots were fired.

September 5.--Again two shots were fired. Six shots completed this week.

September 6.--New radio equipment for Barksdale Plant was checked out and antenna was installed.

September 7.--Rained three inches; operations were canceled for the day. Junction box at the site contained 6 inches of water and sand.

September 8.--Three shots were fired. Ordered Dynafax camera from Beckman-Whitley in San Carlos, Calif.

September 9.--duPont crew was increased to two shifts. Three shots were fired; air-blast measurements were begun. Dynafax camera arrived.

September 11.--Motor generator failed completely; new unit was borrowed from a farm 30 miles away.

September 12.--Thirteen shots were fired this week.

September 16.--Dynafax camera was put into operation.

September 19.--Fifteen shots were fired this week.

September 26.--Upland bird-hunting season began. Eighteen shots (3 per day) were fired this week.

September 30.--Last gap-shot was fired, totaling 60 shots in 24 days and averaging $2\frac{1}{2}$ shots per day.

October 2.--Bureau team departed Ashland for Pittsburgh.

APPENDIX B.--ESTIMATE OF STANDARD DEVIATION OF UP-AND-DOWN RESULTS

No single series of trials was sufficiently extensive to allow a reasonable estimate of the standard deviation of the population of up-and-down results. One needs the standard deviation to make further estimates of low and high probabilities of initiation. Thus, with the usual assumption of normal distribution, an increase of 3.1 standard deviations over the median value (50-percent probability point) gives the point at which there is only an estimated chance of one in a thousand of initiation. It must be emphasized, however, that the up-and-down method is deliberately designed to yield a 50-percent point economically, and it is not particularly effective in estimating the standard deviation. Any error in making this estimate is of course, compounded when the standard deviation is multiplied by a factor to yield an estimated probability near the extreme end of the distribution curve.

To increase the number of results that could be employed in estimating the standard deviation, all of the usable up-and-down results were normalized to a common series of intervals as shown in table B-1. For each series level, b was chosen as the lowest at which all trials gave positive results. The computations, following the original version,¹ are given in the table as well. Calculation of the median value was necessary to convert graphically the statistic M to an estimated standard deviation. The more commonly used formulas are unsatisfactory for $M < 0.3$. A separate computation for the best single series (II) yielded an estimated standard deviation of $0.054 \log_{10}$ units ($N = 4$ compared to $N = 18$ in the combined series) that is in reasonable agreement with the value of $0.048 \log_{10}$ units in the first computation.

TABLE B-1. - Normalized up and-down results

Level	Series I	Series II	Series III	Series IV		Series V			
a.....	Y	Y		Y					
b.....	Y Y Y	Y Y	Y Y	Y Y		Y Y			
c.....	N N Y N	Y N Y Y	Y N N	N Y	N	Y Y			
d.....		N N N	N					N	
e.....									
	Series VII	Series VIII	Series IX	ΣY	ΣN	n	i	ni	ni ²
a.....		Y		4	0				
b.....	Y Y	Y Y	Y	15	0	0	2	0	0
c.....	N Y	N N	N	9	12	12	1	12	12
d.....				0	6	6	0	0	0
e.....	N								
Total						18	-	12	12

¹Y = acceptor initiated.

²N = acceptor failed to initiate.

¹Princeton University, Statistical Research Group. Statistical Analysis of a New Procedure in Sensitivity Experiments. AMP Rept. 101.1R, SRG-P 40. (Available in microfilm from Office Tech. Services, U.S. Dept. Commerce, Washington, D.C.).

Note: Estimate of the mean:

$$\begin{aligned} m &= |d| - d \left(\frac{\sum ni}{N} + \frac{1}{2} \right) \text{ where } N = \sum n, \\ &= |d| - d \left(\frac{12}{18} + \frac{9}{18} \right), \\ &= |d| - 1.2 d. \end{aligned}$$

Estimate of the standard deviation:

$$\begin{aligned} M &= \frac{N(\sum ni^2) - (\sum ni)^2}{N^2}, \\ &= \frac{(18 \cdot 12) - (12)^2}{(18)^2}, \\ &= 0.22. \end{aligned}$$

From graph No. 2 (Princeton University, Statistical Research Group. Statistical Analysis of a New Procedure in Sensitivity Experiments. AMP Rept. 101.1R, SRG-P 40, p. 55.):

$$\sigma \approx 0.4 d = 0.05 \text{ log units.}$$

The value of standard deviation so determined suggests that the original choice of interval reasonably fit the criterion of $2\sigma > d > 1/2\sigma$. Since the standard deviation is expressed in log units, conversion to a percent increase in distance for a low probability of initiation is simply done. Thus 3σ corresponds to 40 percent increase in gap distance over the distance for 50 percent probability of initiation.