

FURTHER STUDIES ON SYMPATHETIC DETONATION

By R. W. Van Dolah, F. C. Gibson, and J. N. Murphy

* * * * * report of investigations 6903

www.ARblast.osmre.gov

US Department of Interior
Office of Surface Mining
Reclamation and Enforcement

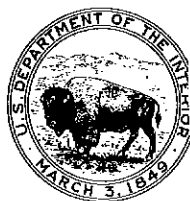

Kenneth K. Eltschlager
Mining/Explosives Engineer
3 Parkway Center
Pittsburgh, PA 15220
Office: 412.937.2169
Cell: 724.263.8143
Keltschlager@osmre.gov

UNITED STATES DEPARTMENT OF THE INTERIOR
Stewart L. Udall, Secretary

BUREAU OF MINES
Walter R. Hibbard, Jr., Director

The work upon which this report is based was done under a cooperative agreement between the Bureau of Mines, U.S. Department of the Interior, and the Manufacturing Chemists' Association, Washington, D.C.

This publication has been cataloged as follows:

Van Dolah, Robert W

Further studies on sympathetic detonation, by Robert W. Van Dolah, F. C. Gibson, and J. N. Murphy. [Washington] U. S. Dept. of the Interior, Bureau of Mines [1966]

35 p. illus., tables. (U. S. Bureau of Mines. Report of investigations 6903)

Includes bibliography.

1. Ammonium nitrate. I. Gibson, Frank C., jt. auth. II. Murphy, J. N., jt. auth. III. Title. (Series)

TN23.U7 no. 6903 622.06173

U. S. Dept. of the Int. Library

CONTENTS

	<u>Page</u>
Abstract.....	1
Introduction.....	1
Experimental procedures.....	4
Design.....	4
Instrumentation.....	5
AN and AN-FO charges.....	9
Dynamite.....	10
Barricades.....	12
Results.....	13
Discussion and conclusions.....	25
Acknowledgments.....	30
References.....	32
Appendix A.--Estimate of standard deviation of up-and-down results.....	33
Appendix B.--Materials used.....	35

ILLUSTRATIONS

Fig.

1. Failure of 60-inch AN-FO acceptor.....	5
2. <u>A</u> , firing site seen from ridge 800 feet away; <u>B</u> , operations area seen from radio tower.....	6
3. Interior of instrument van.....	7
4. Concentric probe for measuring detonation velocities.....	7
5. Field instrumentation.....	8
6. Preparation of 60-inch acceptor charge.....	11
7. Donor charge showing multipoint initiation system.....	11
8. Stacked AN-FO bags with metal-ended donor.....	12
9. Dynamite acceptor showing instrumentation and D'Autriche leads.....	12
10. Forty-inch AN-FO and AN charges separated 5-2/3 feet by a 10-inch barrier.....	13
11. Preparation of 60-inch barricade shot.....	13
12. Up-and-down results for 60-inch-diameter AN and AN-FO acceptors....	14
13. Up-and-down results for 40- and 60-inch-diameter AN and 40-inch AN-FO barricaded acceptors.....	15
14. Up-and-down results for dynamite acceptors.....	16
15. Up-and-down results for bagged AN-FO acceptors.....	17
16. Gap distance versus elapsed time across gaps for 40- and 60-inch charges.....	21
17. Selected frames from Fastax sequence showing fragments and shock waves.....	22
18. Typical airblast pressure profiles.....	24
19. Peak pressure versus scaled distance for AN-FO compared with TNT...	25
20. Plot of American Table of Distances.....	26
21. Plots of S_{50} values versus charge weights.....	27
22. Oscillograms for continuous probes for detonation velocity.....	29

TABLES

	<u>Page</u>
1. Separation distances used in up-and-down technique.....	4
2. Estimated distances for 50-percent initiations (S_{50}).....	18
3. Relative sensitivities of the four types of acceptors as indicated by estimated S_{50} values.....	18
4. Comparison of estimated S_{50} results between 40- and 60-inch sizes and between polyethylene- and metal-ended donors.....	19
5. Comparison of estimated S_{50} values for barricaded and unbarricaded cases.....	19
6. Summary of detonation velocities in 40- and 60-inch AN-FO donors...	20
7. Terminal detonation velocities in AN, AN-FO, and dynamite acceptors.....	21
A-1. Normalized up-and-down results.....	34

FURTHER STUDIES ON SYMPATHETIC DETONATION¹

by

R. W. Van Dolah,² F. C. Gibson,³ and J. N. Murphy⁴

ABSTRACT

The Bureau of Mines extended its investigations into sympathetic detonation of ammonium nitrate (AN) and ammonium nitrate-fuel oil (AN-FO) to define the scaling law for safe separation from detonating AN-FO. Both missile- and non-missile-producing AN-FO donors, weighing up to 5,400 pounds, were employed with acceptors of the same size. The usual cube-root scaling law was not confirmed; exponents for the relationship $S = f(W^x)$ for AN were 0.51 with non-missile-producing donors and 0.61 for missile-producing donors. For AN-FO an exponent of 0.80 was indicated in the missile-producing case. AN-FO in polyethylene bags appeared somewhat more easily initiated than bulk AN-FO. The efficacy of barricades in protecting AN charges was investigated. Sympathetic detonation distances were reduced from one-third to one-seventh when sand-filled barricades were employed. The investigation was extended to boxed dynamite with both types of donors. With 1,600-pound missile-producing donors and an equivalent weight of dynamite, initiation would be expected in 50 percent of the trials at 167 feet. The corresponding value in the non-missile case was 67 feet. The data developed in this program of sympathetic detonation will allow the development of a rational set of safe separation distances for AN, AN-FO, and explosives.

INTRODUCTION

Concern over the proper location of mixing plants for the preparation of ammonium nitrate-fuel oil (AN-FO), particularly with regard to the safe

¹The previous investigation was published as Bureau of Mines Report of Investigations 6746, Sympathetic Detonation of Ammonium Nitrate and Ammonium Nitrate-Fuel Oil, by R. W. Van Dolah, F. C. Gibson, and J. N. Murphy.

²Research Director, Explosives Research Center, Bureau of Mines, Pittsburgh, Pa.

³Project coordinator, Explosives Physics, Explosives Research Center, Bureau of Mines, Pittsburgh, Pa.

⁴Electrical engineer, Explosives Physics, Explosives Research Center, Bureau of Mines, Pittsburgh, Pa.

separation distance of raw ammonium nitrate from the mixed blasting agent, prompted the Bureau of Mines to investigate sympathetic detonation distances for these materials. The results of the initial investigation, conducted in the fall of 1964, have been published.⁵ Charges up to 1,600 pounds were employed as both donors (deliberately initiated) and acceptors, and a multi-point initiation and cylindrical symmetry were used to simulate the core of much larger donor charges. Smaller charges were employed to examine the validity of the usually assumed scaling law in which distance for sympathetic detonation (S) is proportional to the cube root of the explosive weight (W), or

$$S = KW^{1/3},$$

where K is a constant of proportionality.

In the absence of valid data on AN and AN-FO, the "American Table of Distances for Storage of Explosives" (ATD) (4)⁶ was frequently employed to establish safe separation distances. These distances were felt by many to be unnecessarily conservative because AN-FO and especially AN are much less sensitive than the high explosives for which the table was originally developed.

The first investigation (it will be convenient to refer to it as phase 1 and to the present investigation as phase 2) showed that unexpectedly large separation distances were necessary. This was true particularly when metal-ended (fragment-producing) donors were employed. Nevertheless, the distances, especially for raw AN, were substantially less than those given in the ATD. The ATD recommends a separation of 86 feet for 1,600 pounds when the stores are not barricaded, but the results of phase 1 suggested that AN would not initiate at a distance of about 27 feet from a 1,600-pound AN-FO donor even when it produced high-velocity missiles. The corresponding distance for an AN-FO acceptor was 81 feet, surprisingly close to the recommended 86-foot separation distance for high explosives. These results were interpreted in terms of a growth to detonation from threshold initiation conditions, this growth being facilitated by the large charges employed. Further, some of the contradictory data obtained by others in earlier investigations are believed to have resulted from the use of small acceptor charges.

The phase 1 data appeared to support the scaling law, but left an uncertainty as to its real validity in extrapolation to very large charges. Further substantiation could come only with a study of even larger charges because the small-charge data were uncertain. Also, the distances given in the ATD are for barricaded stores with the general recommendation to double the separation distances for unbarricaded situations. As most of the accident data that led to the development of the ATD had involved barricaded stores, the validity of this factor of 2 remained in doubt, particularly in missile-producing cases. The separation distances were about 50 percent larger for

⁵Work cited in footnote 1.

⁶Underlined numbers in parentheses refer to items in the list of references at the end of this report.

AN and threefold larger for AN-FO when metal-ended, rather than polyethylene-ended, donors were employed.

Any question as to the efficacy of the barricades was resolved by a single trial in phase 1 which demonstrated that a simple barricade might be very efficient in preventing sympathetic detonation. The shot, fired at half the distance at which initiations were consistently obtained, failed to initiate AN protected by only a 10-inch-thick sand-filled barricade. Also, a question arose concerning the adequacy of the unbarricaded distances (twice the barricaded distance) in the ATD for high explosives, such as typical dynamites. Earlier work with large donors and small, 50-pound acceptors had led to a table in the Du Pont "Blasters' Handbook" (3) of safe separation distances for dynamite and Nitramon.⁷ The phase 1 results suggested a need to reexamine this question with large acceptors as well as large donors.

Plans were made for a second field study at the same site used for phase 1. This site, located in the Chequamegon National Forest approximately 20 miles west of Ashland, Wis., afforded the advantages of remoteness from neighbors who might be disturbed by the noise and blast effects, and reasonable proximity to the Barksdale plant of E. I. du Pont de Nemours & Co. A use permit for the operation was obtained from the Forest Service, U.S. Department of Agriculture.

Through the generous donations of funds and materials by many interested companies, a cooperative agreement with the Manufacturing Chemists' Association, Inc., was extended. As before, a separate contract was established by the Manufacturing Chemists' Association with E. I. du Pont de Nemours & Co. to provide materials and manpower so that the Bureau's efforts could be largely devoted to planning and instrumenting the shots. With a longer lead time, more extensive and elaborate instrumentation could be organized than was possible in the phase 1 effort.

A program was developed to determine the sympathetic detonation distances for (1) 60- by 60-inch charges, weighing nominally 5,400 pounds, of both AN and AN-FO, (2) 1,600 pounds barricaded charges of 40- by 40-inch and 60- by 60-inch AN and 40- by 40-inch AN-FO, (3) 1,600 pounds of boxed 40 percent extra dynamite, and (4) 1,800 pounds of bagged AN-FO. The latter two weights of material gave nearly cubical piles having about the face area of 40-inch-diameter cylindrical charges. AN-FO donors equal in size to the acceptors (40- by 40-inch for dynamite and bagged AN-FO) and having either metal ends or reinforced-polyethylene ends were employed, except that in the barricade shots only metal-ended donors were used. A total of 59 shots were fired during a period of 36 days in the field.

⁷Reference to trade names is for information only and does not imply endorsement by the Bureau of Mines.

EXPERIMENTAL PROCEDURES

Design

Since the number of shots in experiments of this size is necessarily limited, the Bruceton up-and-down method (2) was again employed. In this experimental design, the separation distance is either increased or decreased on an incremental scale, depending on whether the result of the preceding trial was a detonation or a failure. Once a reversal is found, the trials are made in the vicinity of the median where the probability of either an initiation or a failure is 50 percent.

A normal distribution is a basic assumption of the Bruceton method, and other related investigations have suggested that a logarithmic scale, to the base 10, is preferable to a linear scale. A scale of separation distances was employed in phase 1 in which the log interval was 0.12, representing two times the estimated standard deviation (σ). This estimate was based on other gap test results. The standard deviation estimated from the consolidated and normalized results from phase 1 was 0.05 log units. Although the interval of 0.12 log units is slightly more than the recommended 2σ , as estimated from phase 1, a similar interval was chosen for phase 2 so that the results would be closely comparable. The up-and-down method does not give a good estimate of the standard deviation. The distance scales for both the 40- and the 60-inch donors are given in table 1.

TABLE 1. - Separation distances used in up-and-down technique for 40- and 60-inch donors

40-inch donor		60-inch donor	
Log ₁₀	Gap interval, inches	Log ₁₀	Gap interval, inches
1.60	40	1.78	60
1.72	53	1.90	79
1.84	69	2.02	105
1.96	91	2.14	138
2.08	120	2.26	182
2.20	159	2.38	240
2.32	209	2.50	316
2.44	276	2.62	417
2.56	363	2.74	550
2.68	479	2.86	725
2.80	631	2.98	955
2.92	831	3.10	1,259
3.04	1,097	3.22	1,660
3.16	1,446	3.34	2,188
3.28	1,906		
3.40	2,512		

Instrumentation

The instrumentation used in the phase 2 investigation was similar to that employed in phase 1; however, the physical separation between the firing site and the instrument van was about double that used in the earlier work because of the larger charge sizes. Although more instrument channels were used in phase 2 to provide as much quantitative data as possible, the most important information desired was a positive determination of whether the acceptor did or did not detonate sympathetically. The results were obvious for the cases of very long separation distances that resulted from the use of the larger charges. Whenever the acceptor did not initiate, large fragments of the charge container and plywood end closure would be found together with a large quantity of prills. One extreme case of a 60-inch acceptor shot at 182 feet with a metal-ended donor can be seen in figure 1. Where the donor and acceptor craters were close or overlapped, or when the dynamite acceptor was deliberately destroyed, as will be described, decisions based on interpretation of the instrument records were essential.

Figure 2A shows the charge site from an observation point 800 feet away; figure 2B shows the operations base from the communications tower. A 40-foot bus was used as a workshop and service center, and a four-wheel full trailer housed the instrument, communications, and firing systems. Power was supplied by two 7.5-kw gasoline-driven generators mounted on a trailer.

Instrumentation in the van included five dual-channel oscilloscopes equipped with Polaroid cameras and six 10-mc counter chronographs. The interior of the van is shown in figure 3. The oscilloscopes were used mainly with continuous detonation velocity probes. The chronographs provided time intervals for determining the velocity of the fragments across the gap between

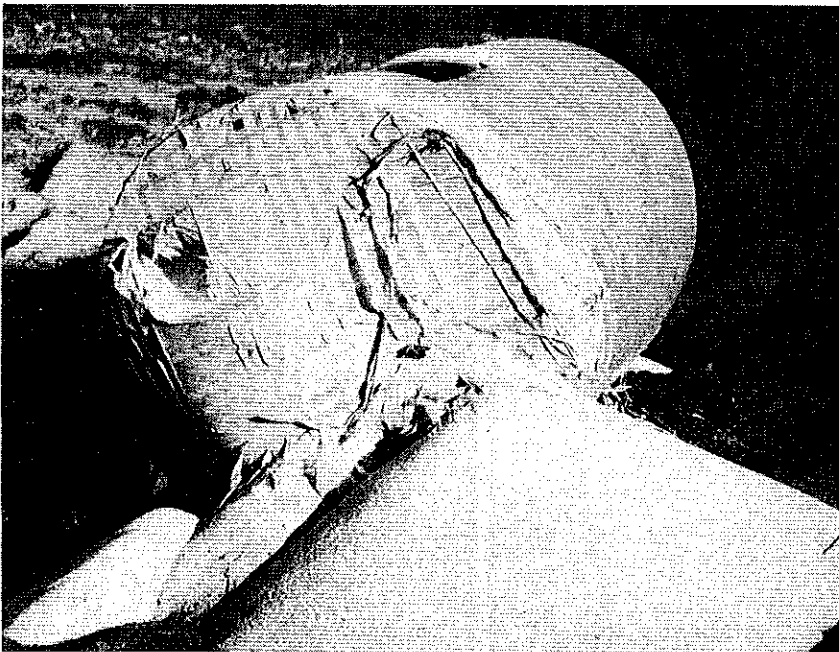
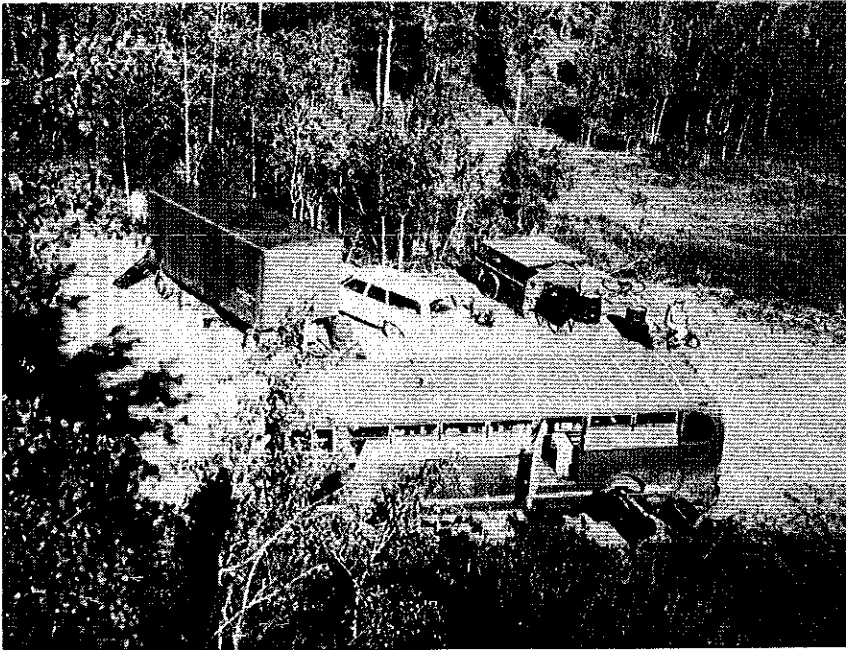

FIGURE 1. - Failure of 60-Inch AN-FO Acceptor Shot With Metal-Ended Donor at 182 Feet.



A



B

FIGURE 2. - A, Firing Site Seen From Ridge 800 Feet Away; B, Operations Area Seen From Radio Tower.

the charges and for measuring detonation velocity using conventional ionization probes placed at intervals in the charges. They were also used to set the high-speed camera to a predetermined framing rate.

The continuous detonation probes were constructed from 0.023-inch-od aluminum tubing having an 0.0015-inch wall thickness, through which was threaded No. 40 insulated resistance wire. In many cases a concentric probe arrangement, shown schematically in figure 4, was used. The inner circuit provided a continuous pressure-sensitive probe; the outer circuit was ionization sensitive. These continuous probes were usually placed both on and off axis in acceptor charges to provide information on the initiation and growth of detonation. The ionization switches used with the counter chronographs were pairs of insulated wires that were placed along the axis of the donors to provide a precise measurement of steady-state detonation velocity.

Expendable pressure gages were used on the downstream end of the acceptors to indicate detonation. Foil switches, consisting simply of two aluminum foil conductors

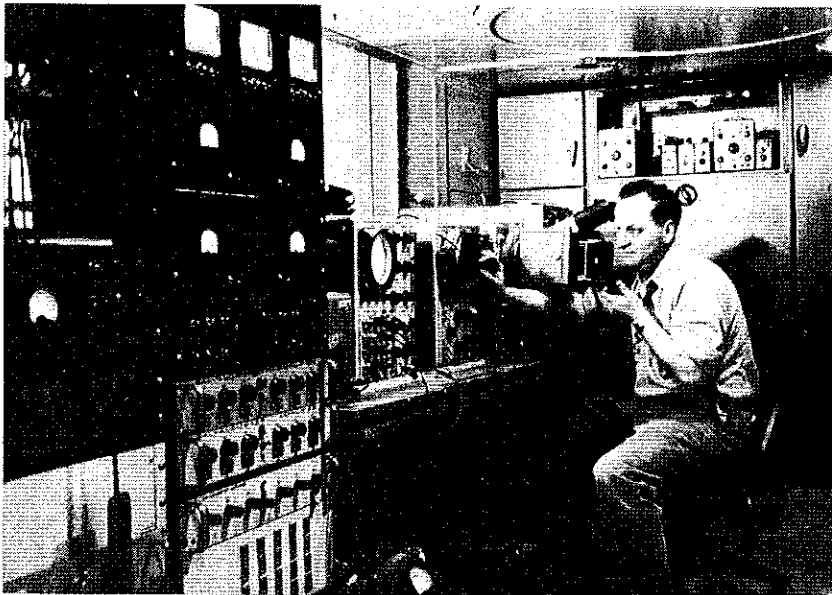

FIGURE 3. - Interior of Instrument Van.

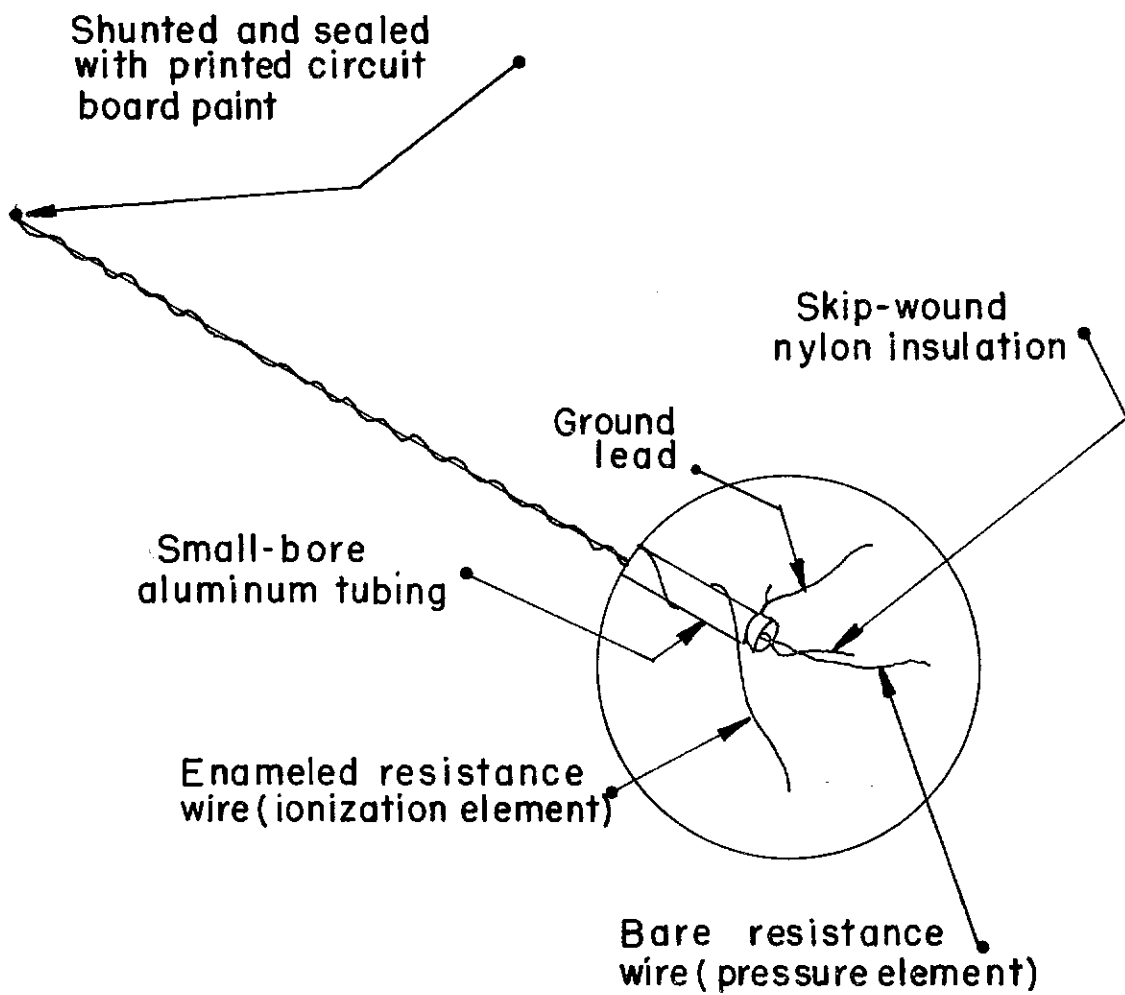

FIGURE 4. - Concentric Probe for Measuring Detonation Velocities.

separated by paper, were used to measure the time of flight of the fragments across the gap separating the charges or across selected increments of the gap. They were also used to determine the time of movement of the barricades and the acceptor charges and, in some cases, to synchronize the oscilloscopes.

Twenty coaxial cables for signal lines extended from the charge site to the trailer about 1,200 feet away. In addition, 24 color-coded conductors were used to power the transducers on the charges and to synchronize the blast gages. The distribution of lines is shown schematically in figure 5. All of the lines from the charge, both for signals and for power, terminated on a patch panel at which each line was shunted and kept floating while the charges were being prepared and instrumented. The panel was closed by a transparent door, provided with a padlock. After the charges were prepared, the instrumentation was checked. The lines were then reshunted while the detonator was attached to a long line of Primacord extending to the donor. Firing was accomplished by an automatic timer which provided the necessary synchronization.

Communications facilities included two base stations, one for communications to the site during charge preparation, and a second for communications to the Du Pont plant at Barksdale, at which a similar station was established. The radio link greatly facilitated ordering materials and supplies and allowed exchange of messages. The second station also communicated with guards and cameramen who were equipped with walkie-talkies. The guards were stationed around the site before and during each shot to maintain security. A two-way

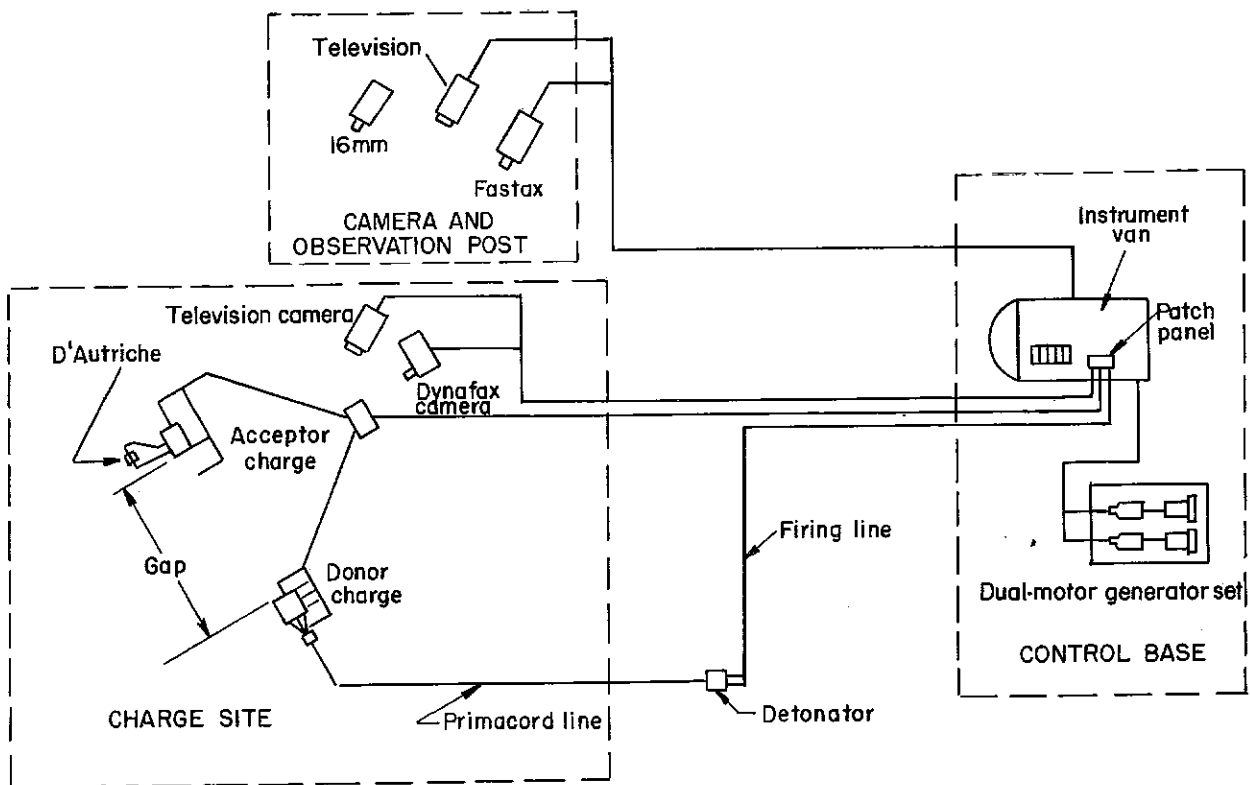

FIGURE 5. - Field Instrumentation.

mobile radio was provided in a vehicle and was used mainly to synchronize sound level measurements that were made $1\frac{1}{2}$ miles from the site. These measurements were made with a General Radio Sound Level Meter Type 1551A equipped with a Type 1556A Impact Noise Analyzer. For further convenience, an intercom was installed between the trailer and the bus workshop. Two closed-circuit television cameras were provided, with one camera located at about 300 feet and the other 800 feet from the charge. A monitor in the trailer could be switched from one camera to the other to provide either closeup or distant views of the charge site after it had been cleared of personnel.

As nonelectric backup to the instrumentation, the D'Autriche method for detonation velocity was employed on the downstream half of each acceptor charge. In the case of the dynamite charges, the D'Autriche method verified the direction of detonation. With the midpoint of the Primacord on the center of the plate, the location of the mark showed whether the charge had been initiated by the donor impact or by the destruct charge at the rear. In many cases, unrealistic velocities were obtained because point initiation gave rise to a phase velocity owing to the curvature of the expanding detonation front.

Standard 16-mm motion pictures were taken of the charge preparation and shots to provide a documentary film. In addition, high-speed photography was provided by a full-frame 16-mm Fastax camera and a Dynafax continuous-writing framing camera capable of speeds to 26,000 frames/sec. The Fastax was generally employed at about 2,000 frames/sec and the Dynafax at 20,000 frames/sec. The high-speed cameras were synchronized automatically to the event from the trailer. In contrast to the phase 1 work where the charge assemblies had to be shifted to new work areas, a bulldozer was employed in phase 2 to backfill craters and provide a level surface on which the charges could be placed. Thus, a single vantage point overlooking the charges could be maintained.

Four self-recording airblast gages were obtained from the Ballistic Research Laboratories (BRL) at Aberdeen Proving Ground, Md., which would provide pressure-time histories of the blasts. The gages had a range of sensitivities that permitted them to be located within a few hundred feet of the charges. Data were reduced by a semiautomatic technique at the Ballistic Research Laboratories.

AN and AN-FO Charges

All of the donors and AN acceptors and most of the AN-FO acceptors, were contained in cylindrical, laminated-fiber forms used for casting concrete. The 40-inch-diameter size could be procured directly, but the 60-inch-diameter containers had to be fabricated by splitting a 40-inch tube and inserting a gusset. The primer ends of the donors and the downstream ends of the acceptors were closed with plywood. The acceptor containers extended beyond the closure to provide an overhang in order to protect instruments and leads from blast and fragments during the delay to initiation. The 40-inch acceptors contained a 40-inch column of AN or AN-FO; the container was 80 inches in length to provide a 40-inch overhang. The 60-inch charges had a 24-inch overhang. The charges were placed on wooden platforms that were aligned and located at the same elevation. When large separation distances were involved, a transit was used to locate the charges.

As in the phase 1 experiments, both polyethylene sheet (reinforced with glass fiber tape) and 16-gage steelplate were employed as donor ends to provide two types of initiating stimuli--one is relatively missile-free and the other composed of fragments from the 1/16-inch-thick metal plate. All acceptors had reinforced polyethylene faces as illustrated in figure 6.

The donors were initiated by the same multipoint primer system used in phase 1. Forty-five RDX primers, weighing 40 grams each, were symmetrically placed inside the plywood end closure. These were connected to equal lengths of Primacord, the opposite ends of which were bundled around a 1-pound cast high explosive primer. The cast primer was connected to a 400-foot length of Primacord to provide an adequate safety distance for installing the electric detonator prior to firing. The same number of RDX primers was used in the 60-inch donors as in the 40-inch size, but the spacing was increased. The primer system is shown in figure 7.

The AN prills were from the same source as those used in phase 1 and the AN-FO mixture prepared from these prills again comprise 95 percent ammonium nitrate and 5 percent fuel oil. Samples of AN from six randomly distributed shots were analyzed for prill size and moisture. Seventy-five percent of the prills passed through 10 mesh (2.0 mm) and were retained on 12 mesh (1.68 mm); an average of 0.9 percent passed 20 mesh (0.84 mm). Comparable data for the AN in phase 1 were 80 percent and 0.7 percent, indicating that the AN prills had essentially the same size distribution as before. The moisture content of the prills used in the phase 2 program, determined by heating in a vacuum over activated alumina, averaged 0.29 percent, compared with 0.05 percent in phase 1. However, this difference is probably not significant to these experiments.

A few shots were made employing acceptors of the same AN-FO in polyethylene bags, each containing 50 pounds. Thirty-six bags, weighing 1,800 pounds, were stacked as shown in figure 8. The face exposed to the donor was 38 inches high and 45 inches wide; the pile with two tiers of bags was 41 inches deep. The bags were banded to a plywood base to inhibit breakup of the pile during initiation.

Dynamite

Two series of experiments were performed on a 40-percent extra dynamite contained in standard fiberboard boxes. Thirty-two boxes were stacked as shown in figure 9 to make a pile 45 inches wide, 38 inches high, and 36 inches deep. The boxes each contained 50 pounds of 2- by 8-inch cartridges and were placed so that the crimped ends were toward the donor. A file of dynamite sticks, from which crimps had been removed, was inserted near the center of the stack to provide a continuous column into which a continuous detonation velocity probe was inserted. A destruct system, consisting of a Primacord line with appropriate millisecond delays, was connected from the upstream end of the donor to the downstream end of the acceptor to prevent dangerous contamination of the site if the acceptor failed to be sympathetically initiated. The length of Primacord and delay times were chosen to provide ample time, usually 20-25 milliseconds, between the arrival of the blast and fragments from the donor and the functioning of the destruct charge. When sympathetic



FIGURE 6. - Preparation of 60-Inch Acceptor Charge.

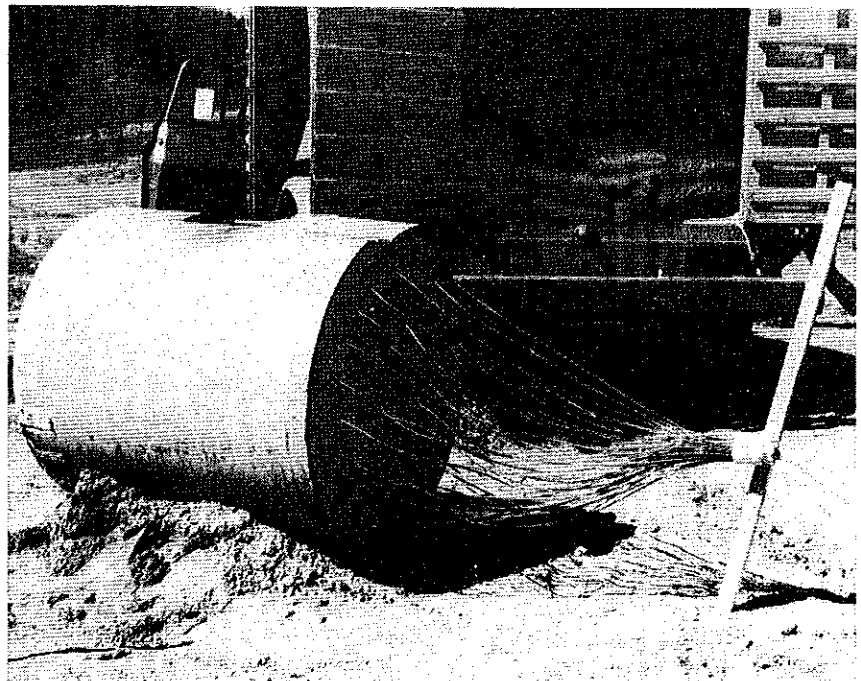

FIGURE 7. - Donor Charge Showing Multipoint Initiation System.



FIGURE 8. - Stacked AN-FO Bags With Metal-Ended Donor.



FIGURE 9. - Dynamite Acceptor Showing Instrumentation and D'Auric Leads.

detonation occurred it took place in less than 0.1 msec after impact. The Primacord line was buried to prevent its being cut by fragments. Positive initiation was insured by terminating the Primacord with a 40-gram RDX pellet inserted in a bottom box. The boxes were stacked on a plywood base and wire bands secured the two stacks in each pile. Thus, the integrity of the pile could be maintained for a sufficiently long time to allow the delayed destruct system to initiate the entire pile reliably.

The dynamite had a detonation velocity of 3.6 mm/ μ sec as measured in the 2-inch cartridges. Its airgap sensitivity was determined by a halved-cartridge gap test (6). Initiations were obtained at 53 inches and failures at 61 inches.

Barricades

The efficacy of sand-filled barricades was studied employing 40- and 60-inch AN acceptors and 40-inch AN-FO acceptors. AN-FO donors of the same size as the acceptors were

used in all cases. The barricades were constructed of $\frac{1}{2}$ -inch plywood without metal fasteners, employing instead horizontal and vertical 2- by 4-inch stringers held in place with wooden spacers, dowels, and wedges. For the 40-inch charge trials the barricades were 4 feet by 8 feet with 10 inches between inside faces. For the 60-inch trials the barrier was 50 percent

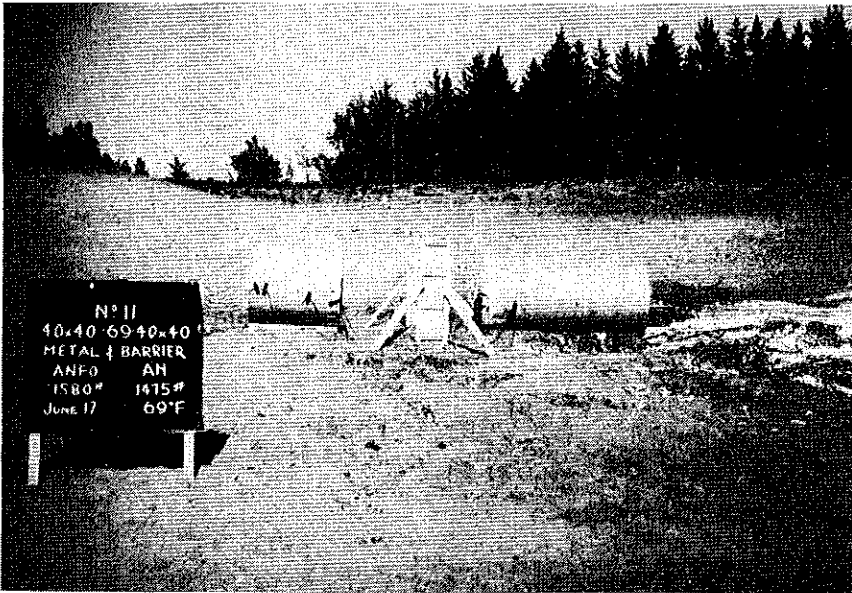

FIGURE 10. - Forty-Inch AN-FO and AN Charges Separated 5-2/3 Feet by a 10-Inch Barrier. Two failures in three shots occurred at this distance.

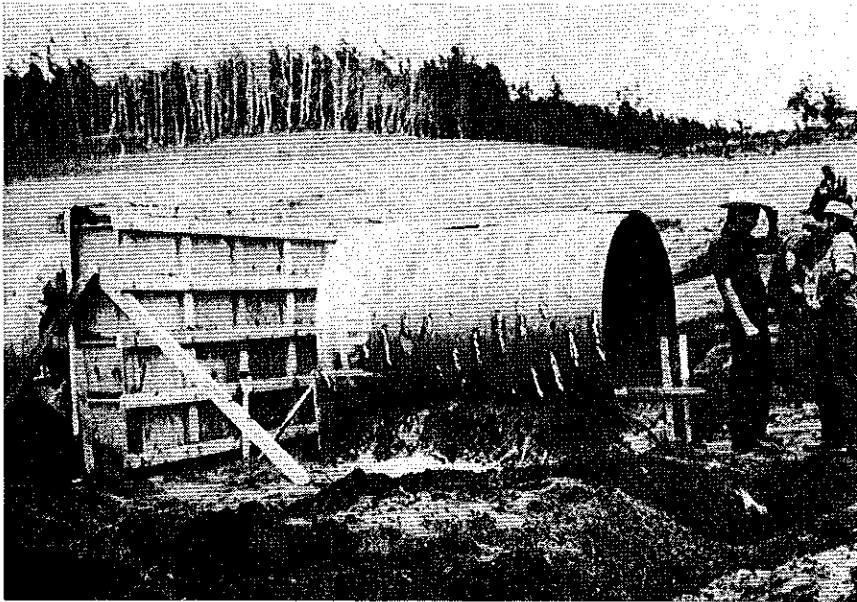

FIGURE 11. - Preparation of 60-Inch Barricade Shot.

larger in each dimension. Thus, the thickness of the barricade was scaled to one-fourth the charge diameter. Similarly, the distance between opposing faces of the barricade and the acceptor was maintained at one-half the charge diameter. Sandy soil from the site was used to fill the barricades. A 40-inch shot, ready for firing, is shown in figure 10, and the preparation of a 60-inch shot is illustrated in figure 11.

RESULTS

Results obtained from the four basic experiments--the 60-inch trials with both AN and AN-FO, the comparison shots with dynamite, the barricade shots, and those involving bagged AN-FO--are shown in figures 12, 13, 14, and 15. Individual shot results are given as well as S_{50} values; that is, those distances at which initiations are expected to occur in 50 percent of the trials. A new technique (1), designed to accommodate small

numbers of trials was used to compute the S_{50} values rather than the usual method of treating Bruceton up-and-down data (2). The up-and-down series from phase 1 were similarly treated by the new method. The S_{50} values from both phase 1 and phase 2 are summarized in table 2.

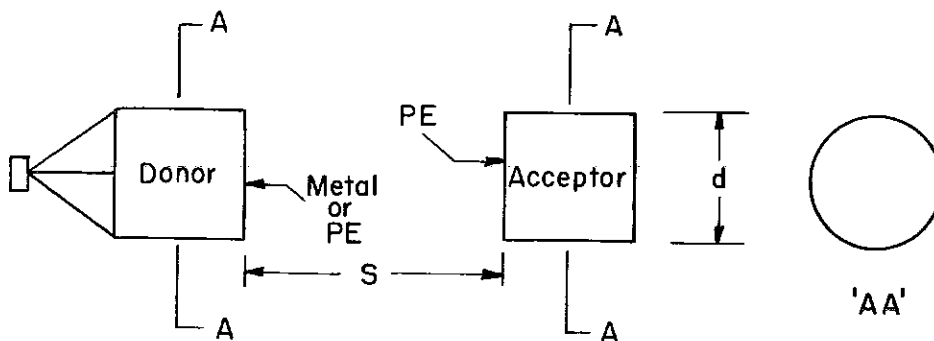

SERIES 1

	Gap, inches	Shot No.						
Acceptor:		5	8	12	26	34	42	
AN- 60- by 60-inch	240	Y		Y		Y		$S_{50} = 276$ inches = 23 feet
5,400-lb	316		N		N		N	
Donor:								
AN-FO - 60- by 60-inch								
5,400-lb								
Polyethylene end								

SERIES 2

	Gap, inches	Shot No.						
Acceptor:		6	10	21	29	32	45	
AN- 60- by 60-inch	417	Y		Y		Y		$S_{50} = 479$ inches = 40 feet
5,400-lb	550		N		N		N	
Donor:								
AN-FO - 60- by 60-inch								
5,400-lb								
Metal end								

SERIES 3

	Gap, inches	Shot No.							
Acceptor:		13	20	30	37	38	50	54	
AN-FO - 60- by 60-inch	955	Y							$S_{50} = 1,840$ inches = 153 feet
5,400-lb	1,259		Y				Y		
Donor:									
AN-FO - 60- by 60-inch	1,660			Y		N		Y	
5,400-lb	2,188					N			
Metal end									

FIGURE 12. - Up-and-Down Results for 60-Inch-Diameter AN and AN-FO Acceptors.

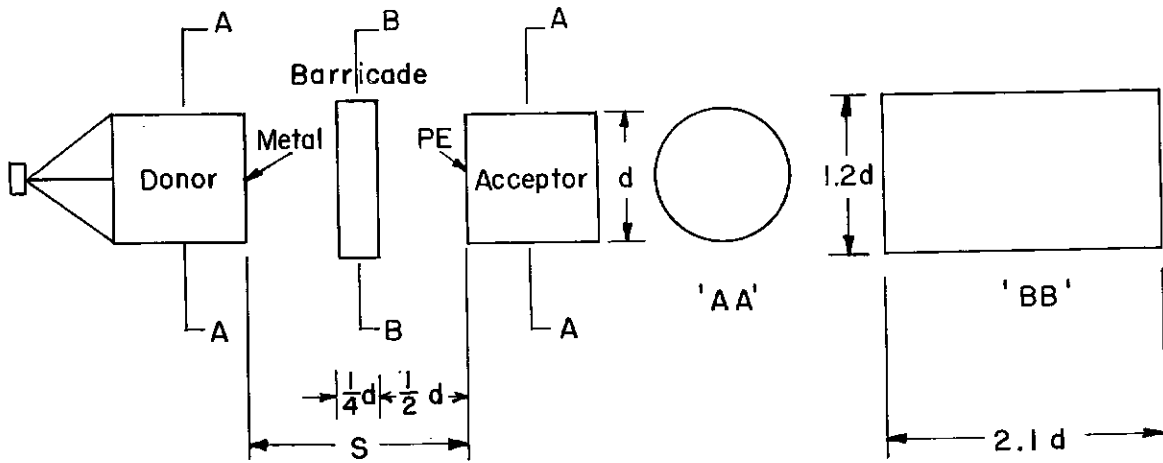

SERIES 4

<p>Acceptor: AN - 40- by 40-inch 1,600-lb 10-inch barrier</p>	<table border="0"> <tr> <td>Gap, inches</td> <td>7</td> <td>11</td> <td>15</td> <td>19</td> <td>43</td> <td>49</td> </tr> <tr> <td></td> <td>53</td> <td>Y</td> <td>Y</td> <td>Y</td> <td></td> <td></td> </tr> <tr> <td></td> <td>69</td> <td></td> <td>N</td> <td>N</td> <td>Y</td> <td></td> </tr> </table>	Gap, inches	7	11	15	19	43	49		53	Y	Y	Y				69		N	N	Y		<p>Shot No.</p>	<p>$S_{50} = 70$ inches $= 5.8$ feet</p>
Gap, inches	7	11	15	19	43	49																		
	53	Y	Y	Y																				
	69		N	N	Y																			
<p>Donor: ANFO - 40- by 40-inch 1,600-lb</p>																								

SERIES 5

<p>Acceptor: AN - 60- by 60-inch 5,400-lb 15-inch barrier</p>	<table border="0"> <tr> <td>Gap, inches</td> <td>23</td> <td>27</td> <td>34</td> <td>51</td> </tr> <tr> <td></td> <td>79</td> <td>Y</td> <td>Y</td> <td></td> </tr> <tr> <td></td> <td>105</td> <td>N</td> <td>N</td> <td></td> </tr> </table>	Gap, inches	23	27	34	51		79	Y	Y			105	N	N		<p>Shot No.</p>	<p>$S_{50} = 92$ inches $= 7.7$ feet</p>
Gap, inches	23	27	34	51														
	79	Y	Y															
	105	N	N															
<p>Donor: ANFO - 60- by 60-inch 5,400-lb</p>																		

SERIES 6

<p>Acceptor: ANFO - 40- by 40-inch 1,600-lb 10-inch barrier</p>	<table border="0"> <tr> <td>Gap, inches</td> <td>9</td> <td>17</td> <td>35</td> <td>40</td> <td>46</td> </tr> <tr> <td></td> <td>91</td> <td></td> <td>Y</td> <td></td> <td></td> </tr> <tr> <td></td> <td>120</td> <td></td> <td>N</td> <td>N</td> <td></td> </tr> <tr> <td></td> <td>159</td> <td></td> <td>N</td> <td></td> <td></td> </tr> </table>	Gap, inches	9	17	35	40	46		91		Y				120		N	N			159		N			<p>Shot No.</p>	<p>$S_{50} = 94$ inches $= 7.8$ feet</p>
Gap, inches	9	17	35	40	46																						
	91		Y																								
	120		N	N																							
	159		N																								
<p>Donor: ANFO - 40- by 40-inch 1,600-lb</p>	<table border="0"> <tr> <td></td> <td>209</td> <td>N</td> <td></td> <td></td> </tr> </table>		209	N																							
	209	N																									

FIGURE 13. - Up-and-Down Results for 40- and 60-Inch-Diameter AN and 40-Inch AN-FO Barricaded Acceptors.

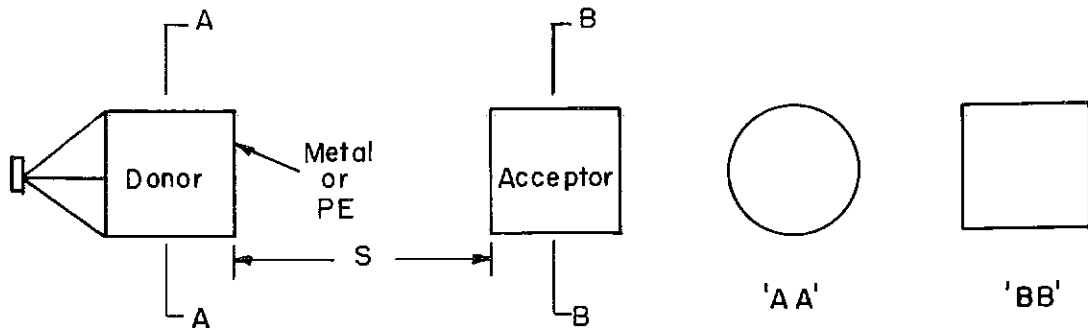

SERIES 7

Donor:	Gap, inches	Shot No.								S ₅₀ =800 inches = 67 feet
		14	16	24	28	33	39	44	48	
Acceptor: Dynamite - 38- by 45- by 35-inch 1,600 lb	276	Y								
	363	-								
Donor: ANFO - 40- by 40-inch 1,600 lb	479	Y								
Polyethylene end	631			Y		Y				
	832				N		Y		N	
	1,097								N	

SERIES 8

Donor:	Gap, inches	Shot No.						S ₅₀ =2000 inches = 167 feet
		18	22	25	36	41	47	
Acceptor: Dynamite - 38- by 45- by 35-inch 1,600 lb	1,446		Y					
	1,906	N		Y		Y		
Donor: ANFO - 40- by 40-inch 1,600 lb	2,512				N		N	
Metal end								

FIGURE 14. - Up-and-Down Results for Dynamite Acceptors.

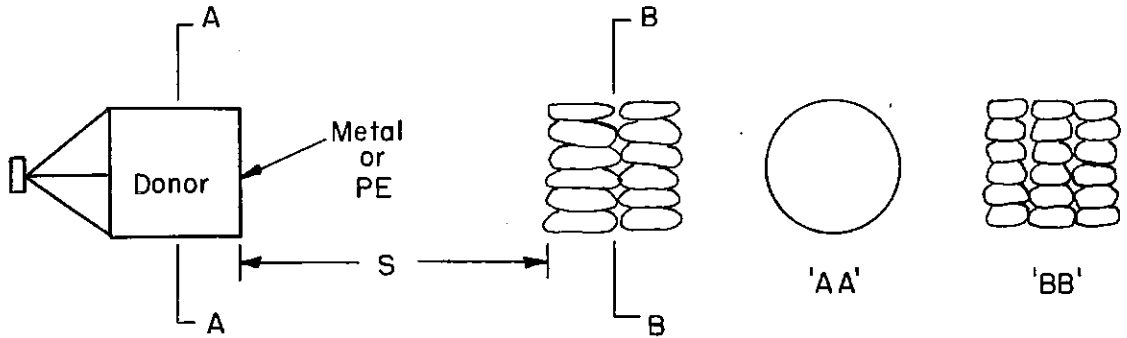

SERIES 9	Gap, inches	Shot No.	
Acceptor:		53 55 57	
ANFO bags - 38- by 41- by 45-inch 1,800-lb	209	Y	
	276	Y	
Donor:	363	N	$S_{50} = 326$ inches = 27 feet
ANFO - 40- by 40-inch 1,600-lb			
Polyethylene end			

SERIES 10	Gap, inches	Shot No.	
Acceptor:		52 56 58 59	
ANFO bags - 38- by 41- by 45-inch 1,800-lb	631	Y	
	832	Y	
Donor:	1097	Y	$S_{50} = 1,300$ inches = 108 feet
ANFO - 40- by 40-inch 1,600-lb	1446	N	
Metal end			

FIGURE 15. - Up-and-Down Results for Bagged AN-FO Acceptors.

TABLE 2. - Estimated distances for 50-percent initiations (S_{50})

Series	Donor size, inches	Donor end ¹	Acceptor	S_{50} , feet
Phase 1:				
1.....	40 by 40	PE.....	AN.....	12.5
2.....	40 by 40	M.....	AN.....	19
3.....	20 by 20	M.....	AN.....	12.5
4.....	40 by 40	M.....	AN-FO.....	58
5.....	40 by 40	M.....	AN ²	25
7.....	40 by 40	PE.....	AN-FO.....	19
8.....	20 by 20	PE.....	AN.....	2.5
9.....	40 by 40	M.....	AN-M ³	15
Phase 2:				
1.....	60 by 60	PE.....	AN.....	23
2.....	60 by 60	M.....	AN.....	40
3.....	60 by 60	M.....	AN-FO.....	153
4.....	40 by 40	M-B.....	AN.....	5.8
5.....	60 by 60	M-B.....	AN.....	7.7
6.....	40 by 40	M-B.....	AN-FO.....	7.8
7.....	40 by 40	PE.....	Dynamite.....	67
8.....	40 by 40	M.....	Dynamite.....	167
9.....	40 by 40	PE.....	AN-FO ⁴	27
10.....	40 by 40	M.....	AN-FO ⁴	108

¹PE = polyethylene reinforced by glass fiber tape; M = metal (16-gage steelplate; M-B = metal (16-gage steelplate) with barricade.

²Heated to 180° F.

³Acceptor had 16-gage steel face.

⁴Bagged.

The data show that the metal-ended donors were much more effective than the polyethylene-ended ones, causing initiation over about 2 to 4 times the distances. The relative distances for the different acceptor materials fall generally in accord with their usually accepted relative sensitivities (AN < AN-FO < dynamite) as shown in table 3. The results for bagged AN-FO were unexpectedly different from those for bulk AN-FO, but it must be appreciated that the small number of trials together with the rather large intervals used in the up-and-down procedure did not allow highly precise determinations of S_{50} .

TABLE 3. - Relative sensitivities of the four types of acceptors as indicated by estimated S_{50} values

Donor, size inches	Acceptor	S_{50} , feet	
		Polyethylene	Metal
40	AN.....	12.5	19
40	AN-FO.....	19	58
40	AN-FO ¹	27	108
40	Dynamite.....	67	167
60	AN.....	23	40
60	AN-FO.....	-	153

¹Bagged.

The S_{50} estimates for the two 60-inch AN series were about 2 times the corresponding 40-inch values obtained in phase 1. The single 60-inch AN-FO series (metal-ended donors) gave an S_{50} estimate about 2.5 times the corresponding 40-inch value from phase 1. The cube-root scaling law would predict increases of only 50 percent (1.5 times). The comparisons of metal- and polyethylene-ended donors and 40- and 60-inch charges are shown in table 4.

TABLE 4. - Comparison of estimated S_{50} results between 40- and 60-inch sizes and between polyethylene- and metal-ended donors

Size, inches	Donor end ¹	S_{50} , feet	60-inch to 40-inch ratio	M to PE ratio
AN:				
40 by 40.....	PE	12.5	} 23 to 12.5 = 1.8	19 to 12.5 = 1.5
60 by 60.....	PE	23		
40 by 40.....	M	19	} 40 to 19 = 2.1	40 to 23 = 1.7
60 by 60.....	M	40		
AN-FO:				
40 by 40.....	PE	19	-	-
40 by 40.....	M	58	} 153 to 58 = 2.6	58 to 19 = 3.1
60 by 60.....	M	153		
Bagged AN-FO:				
40 by 40.....	PE	27	-	} 108 to 27 = 4.0
40 by 40.....	M	108	-	
Dynamite:				
40 by 40.....	PE	67	-	} 167 to 67 = 2.5
40 by 40.....	M	167	-	

¹PE = polyethylene; M = metal.

The sand-filled barricades were extremely effective in reducing the sympathetic detonation distances to about one-third to one-seventh the corresponding unbarricaded distances as given in table 5. The distances at which the acceptors were initiated placed them within the limits of the craters from the donors.

TABLE 5. - Comparison of estimated S_{50} values for barricaded and unbarricaded cases

Size, inches	Donor end	Acceptor	S_{50} , feet		U to B ratio
			Unbarricaded (U)	Barricaded (B)	
40	Metal.....	AN.....	19	5.8	3.3
60	..do.....	AN.....	40	7.7	5.2
40	..do.....	AN-FO.....	58	7.8	7.4

Detonation velocities in a number of donors were obtained by counter chronograph measurements with axial probes. A summary of the data is given in table 6. The continuous-probe data show greater variability than the data from the counter chronographs. Particularly the continuous-probe data for the 60-inch charges are unexplainably low. The data for the 40-inch charges show a slight overdriving of the velocity by the primer system over the first portion of the charge. The best data to compare diameter effects are those obtained from the counter chronographs over the second half of the charges. Here the velocities for the 40-inch-diameter donors averaged 4.5 mm/ μ sec and those for the 60-inch donors averaged 4.7 mm/ μ sec, indicating that the limiting diameters had been nearly reached in the 40-inch charges and that the detonation was nearly ideal in both cases. The results for the 40-inch charges are probably more representative of the true detonation velocity than those reported from the phase 1 investigation, wherein axial continuous probes suggested a rate of 5.4 mm/ μ sec and probes on the periphery of the charges gave only 4.3 mm/ μ sec.

TABLE 6. - Summary of detonation velocities in 40- and 60-inch AN-FO donors, mm/ μ sec

40-inch donor			60-inch donor		
Continuous probe	Counter chronograph		Continuous probe	Counter chronograph	
	1st half	2d half		1st half	2d half
4.63	4.8	4.6	4.3	4.5	4.5
4.42	4.8	4.6	4.23	-	4.7
4.1	-	4.2	4.3	4.6	4.6
4.5			4.43	4.8	4.9
4.4	14.8	14.5	4.28	4.7	4.9
4.8					4.5
4.8			14.3	4.6	-
4.8				4.6	4.7
14.5				-	4.7
				14.6	14.7

¹Average.

Terminal velocities of detonation in the AN, AN-FO, and dynamite acceptors are summarized in table 7. The velocities in the 40-inch AN acceptors ranged from 1.2 to 2.5 mm/ μ sec for an average of 1.8 mm/ μ sec. These may be compared to a range of 1.3 to 4.1 mm/ μ sec obtained in phase 1. The 60-inch AN acceptors gave velocities ranging from 1.2 to 3.8 mm/ μ sec and averaging 2.4 mm/ μ sec. The detonation velocity in the 60-inch AN-FO acceptors ranged from 3.5 mm/ μ sec to 4.3 mm/ μ sec, never quite equaling the velocities obtained in the AN-FO donors of the same size.

The detonation velocities measured in the dynamite acceptors were consistently higher than the velocity measured on 2-inch cartridges. The file of cartridges in the acceptor was in the center of the stacked boxes, forming the core of a much larger charge. The average rate of 4.4 mm/ μ sec thus probably represents a good estimate of the ideal detonation velocity of the dynamite used.

TABLE 7. - Terminal detonation velocities in AN, AN-FO, and dynamite acceptors, mm/μsec

AN		AN-FO		Dynamite
40-inch	60-inch	40-inch	60-inch	
2.4	1.2	3.0	4.3	4.4
2.5	3.6		4.0	3.8
1.9	1.9		3.5	4.8
1.5	3.8		3.8	4.4
1.2	1.4		13.9	3.8
1.4	2.3			4.9
¹ 1.8	2.8			¹ 4.4
	¹ 2.4			

¹Average.

Shock or fragment velocities across the gap were determined by foil switches used with counter chronographs. These extended the data obtained from the phase 1 work to much larger gaps. Figure 16 shows gap distances versus elapsed time across the gap. An average velocity is observed that ranges from 3.2 mm/μsec to somewhat less than 1.8 mm/μsec for the longest standoff distances employed. A maximum velocity of 5.3 mm/μsec was found about 30 cm from the donor face in phase 1. Scatter in the data beyond 100 feet may represent the region in which the switches on the acceptor charges

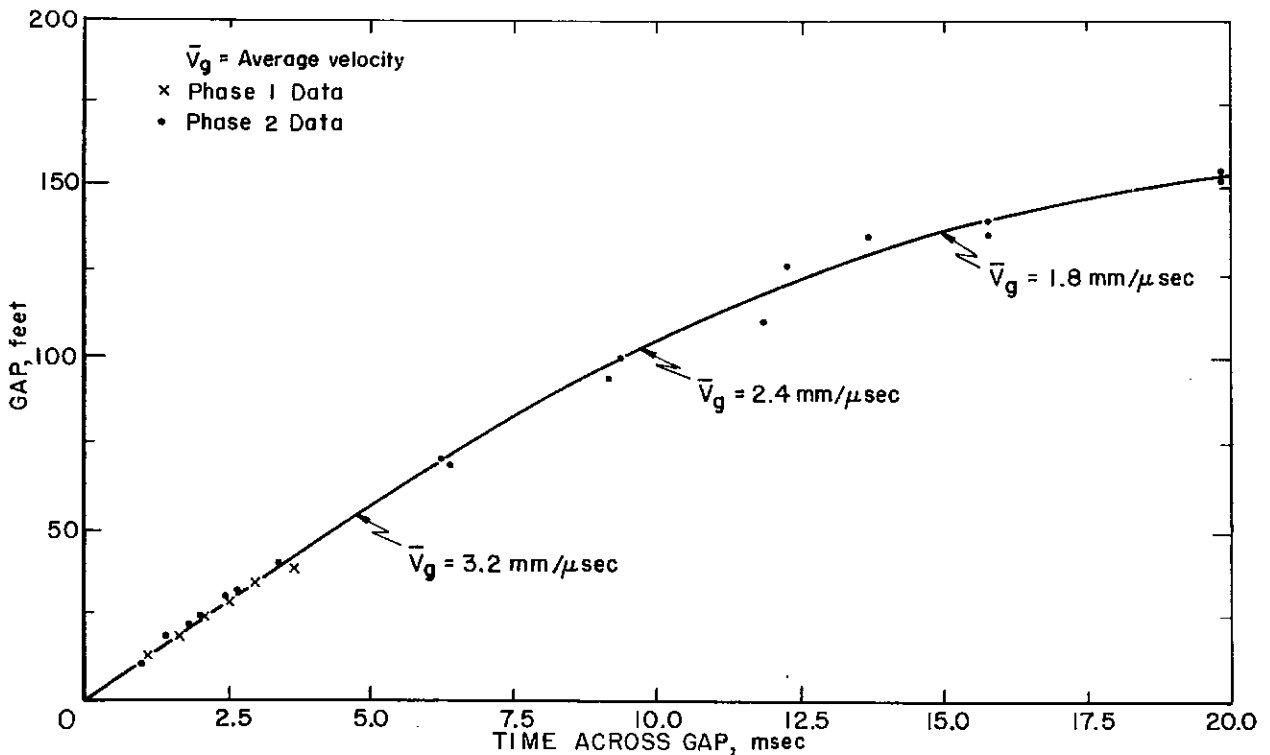

FIGURE 16. - Gap Distance Versus Elapsed Time Across Gaps for 40- and 60-Inch Charges.

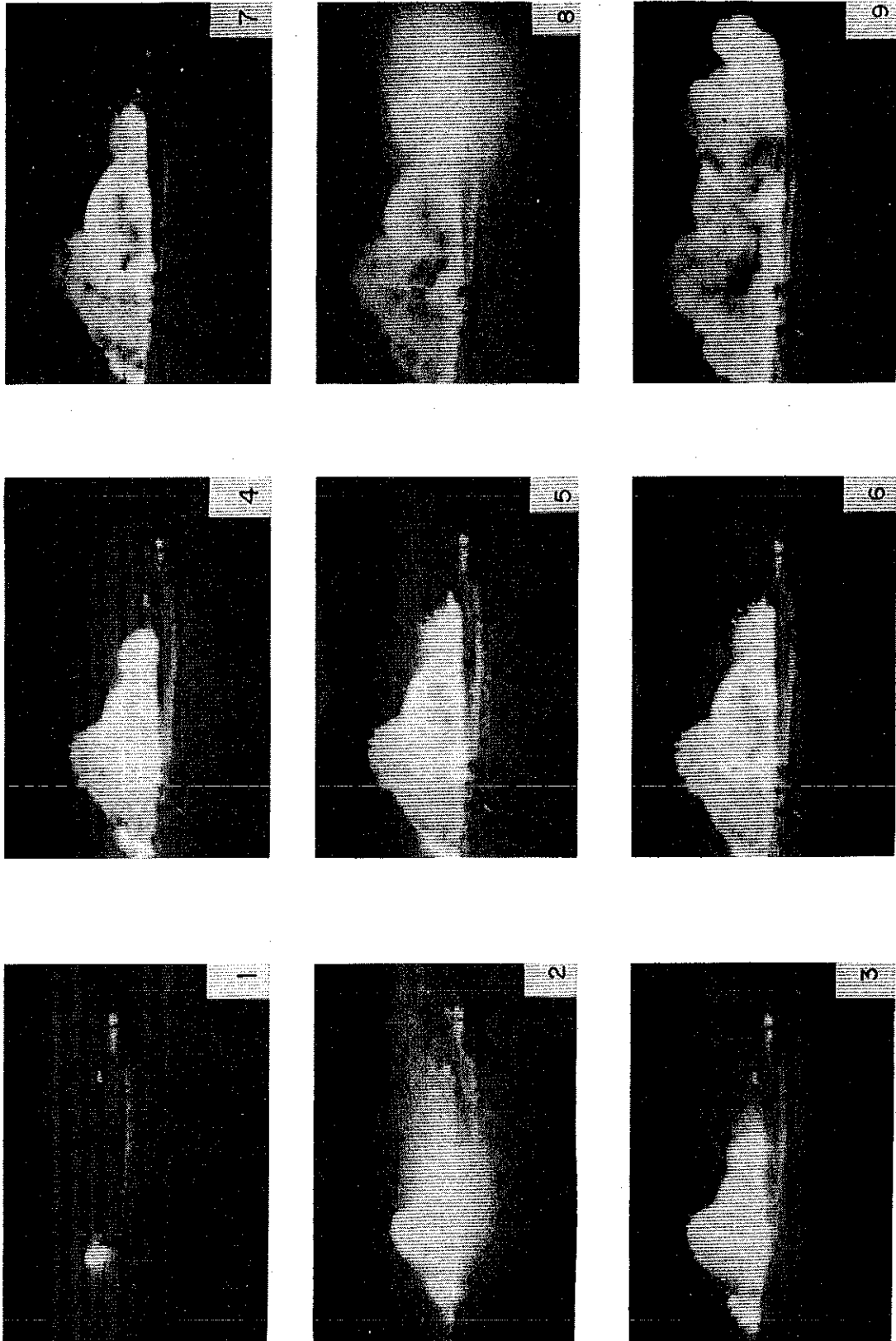

FIGURE 17. - Selected Frames From Fastax Sequence Showing Fragments and Shock Waves. Time between frames shown is 0.8 millisecond.

are no longer influenced by the shocks but only by fragments that may have random velocities.

Selected frames from a sequence of photographs obtained with the Fastax framing camera are shown in figure 17, which illustrates the initiation of a 60-inch AN-FO acceptor at a separation of 105 feet from a metal-ended donor. A camera framing rate was 2,500 frames/sec, providing an interframe time of 0.4 millisecond. However, since alternate frames are shown in the figure, the interframe time is 0.8 millisecond. In frame 1, the donor has been initiated. Frames 2 through 5 show the growth of the donor product's cloud and fragments which are directed toward the acceptor. In frames 6 and 7, the acceptor is obscured by the donor product's cloud and by frame 8 the acceptor has detonated. The interaction of the shocks from the donor and from the acceptor is clearly visible in frame 9.

The peak overpressure profiles for donor and acceptor charges were recorded using BRL self-recording, time-resolved pressure gages. In phase 2, the data were obtained for 1,600- and 5,400-pound charges with the gages located normal to the common axis of the donor and acceptor charges. The arrangement for a given shot usually consisted of three gages, rated at 50, 25, 10, or 5 psi, located from 100 to 250 feet from the charges.

Figure 18 shows two typical pressure profiles obtained with the BRL gages. In A the charge was a 5,400-pound AN-FO donor and the peak pressure was 28.7 psi, in good agreement with an expected pressure of 25.5 psi from TNT. The duration is also similar to that of a TNT wave. In B two peaks of equal amplitude were recorded for a 1,600-pound AN-FO donor and an equal size acceptor.

The peak overpressure data, shown in figure 19, are for all shots in which the acceptor charge failed to detonate or where the acceptor was AN-FO and the charge separation was sufficient to permit the pressure wave at the recording station to have two distinct pressure pulses. Actual distances to the charge were used to compute scaled distances. As in the results from the phase 1 work, there is a good correlation with TNT airblast data (5).

Peak sound-pressure levels (SPL) measured about 1-1/2 miles from the firing site, varied over a wide range with poor correlation with the size of charge. For the 40-inch charges SPL's ranged from 111 to 124 decibels (db) with an average of 116 db, while the 60-inch charges gave only slightly increased levels of 113 to 127 db. The highest level recorded, 127 db, was for a 60-inch barricaded AN shot. Type of acceptor charge showed some correlation with SPL values. Thus the average for shots with AN acceptors was 115 db, compared with 122 db for shots with AN-FO. Dynamite shots ranged from 103 db to 124 db, with an average of 110 db, or about 5 db less than the average for 40-inch AN and AN-FO charges. Large separation distances giving time-separated shots were probably responsible for this difference. Terrain and locally variable winds undoubtedly played the most important role. Significantly, no complaints were received from neighbors.

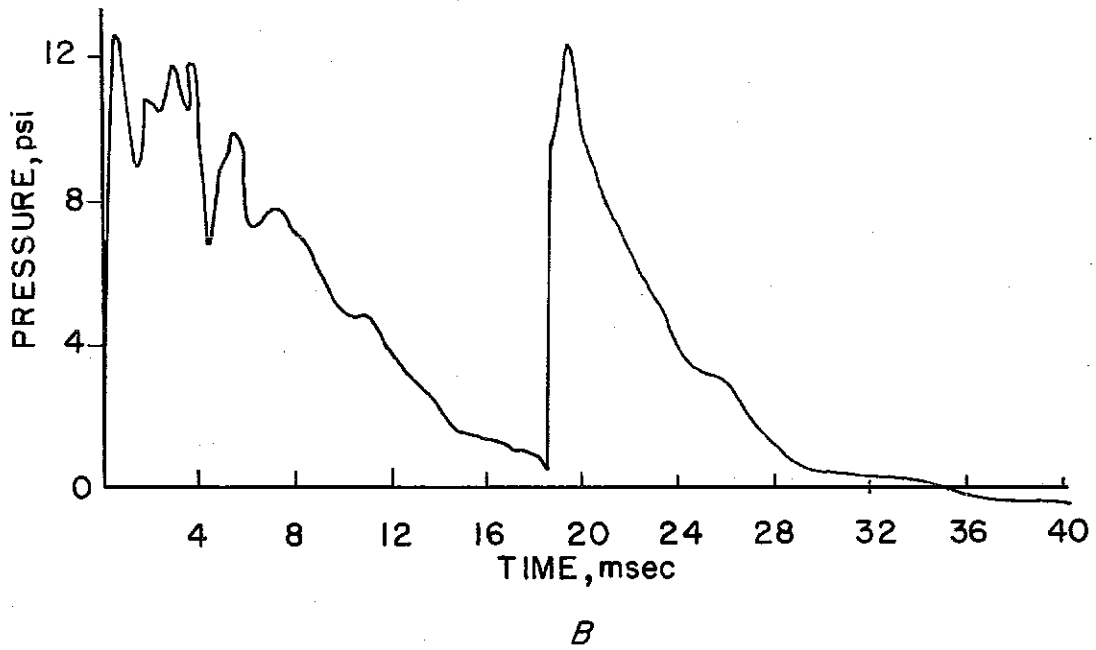
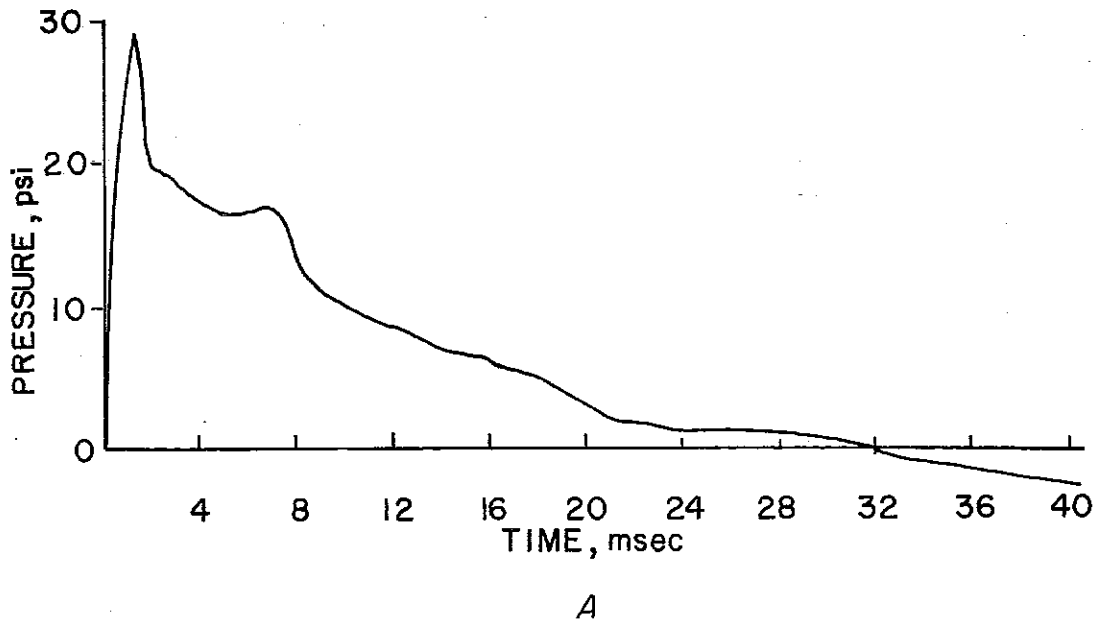

FIGURE 18. - Typical Airblast Pressure Profiles. A, 5,400-pound AN-FO donor at 110 feet; B, 1,600-pound AN-FO donor and AN-FO acceptor showing two separate blast waves.

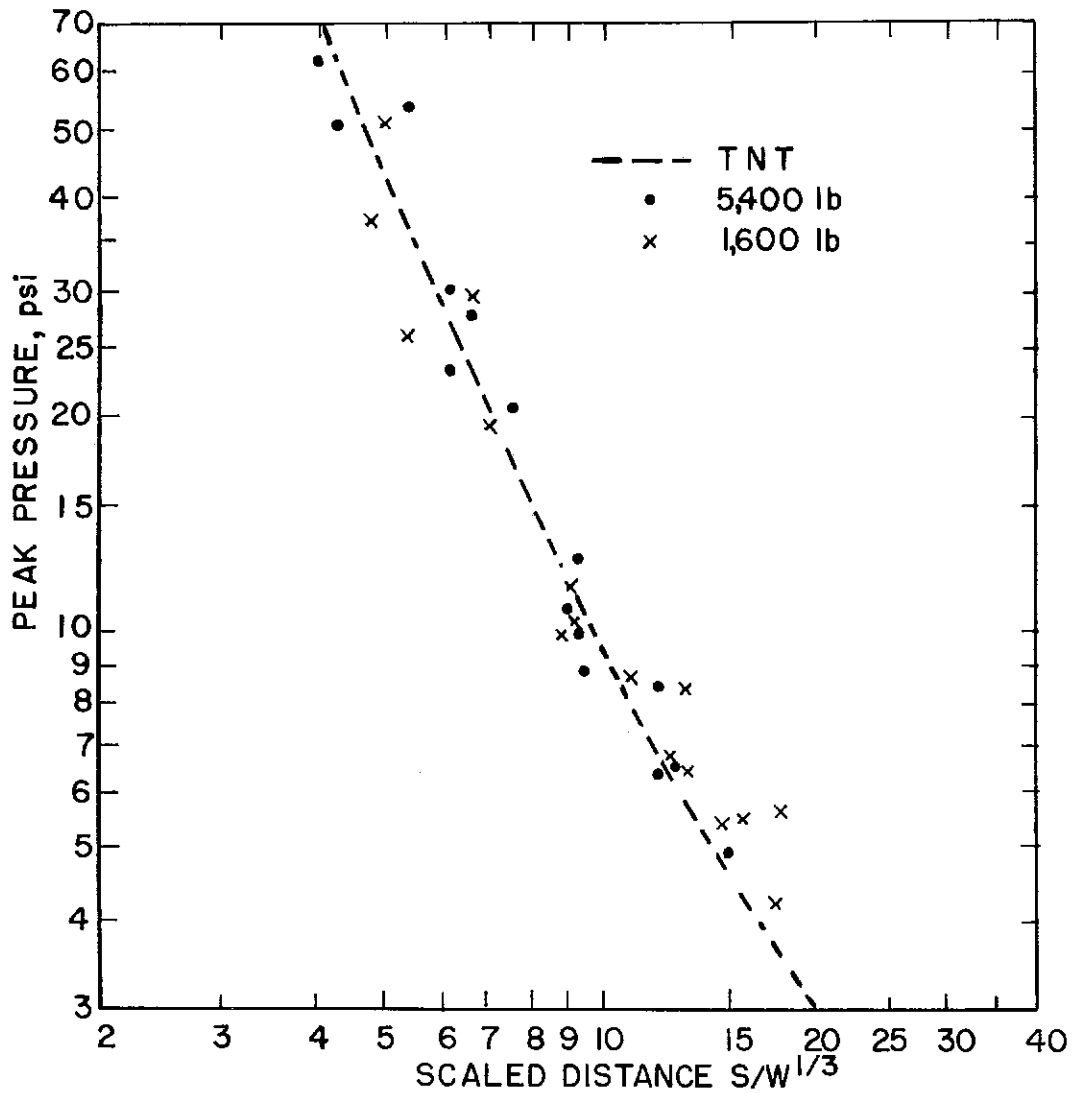

FIGURE 19. - Peak Pressure Versus Scaled Distance for AN-FO Compared With TNT.

DISCUSSION AND CONCLUSIONS

The basic data resulting from both experimental phases, the S_{50} values, immediately reveal two rather startling conclusions. First, unbarricaded stores are sympathetically initiated over surprisingly great distances and the distances do not appear to scale to the cube root of the charge weight. Secondly, the barricades are extremely effective and the distances for sympathetic detonation, of AN and AN-FO employing the barricades of the design used in this study, are surprisingly small. Comparable distances for separation of barricaded charges of more sensitive explosives should not be inferred. The factor of 2 in the separation distances, usually recommended for barricaded and unbarricaded stores, is seriously in error. A factor of 6 would appear to be more realistic if missiles from the donor are possible and if the acceptor is not in a bullet-resistant magazine.

The failure of the cube-root scaling law was shown by the ratios of separation distances for the 60-inch charges to the 40-inch charges. These were consistently about 2 to 2-1/2 instead of the 1-1/2 ratio required by the cube-root scaling law. The internal consistency of the data suggested a deeper study of the results. Examination of the American Table of Distances revealed that a constant scaling law is not employed in the table. Figure 20 is a log-log plot of the recommended separation distances for barricaded magazines. The slope of the line gives the exponent in the equation $S = f(W^x)$, which is 0.33, corresponding to the cube root of the charge weight up to 40,000 pounds. Beyond 40,000 pounds the exponent increases up to a maximum of 0.76 for the 200,000 to 300,000 pounds range. Presumably, accident data, on which the American Table of Distances was originally based, revealed the necessity for greater separation distances for the very large stores of explosives than would be suggested by the cube-root scaling law. Similar plots of the data derived from this study and from phase 1 are given in figure 21. Only the barricaded AN data fall close to the cube-root scaling law; an exponent of 0.27 is suggested. The results for unbarricaded AN with polyethylene-ended donors gave an exponent of 0.51; metal-ended donors gave an exponent of 0.61. The data for AN-FO with metal-ended donors yield an exponent of 0.80, which is in reasonable agreement with 0.76, the largest exponent in the American Table of Distances plot.

The basic design of the experiment, it may be recalled, sought to simulate or model a much larger charge by the axial alignment of the donor and

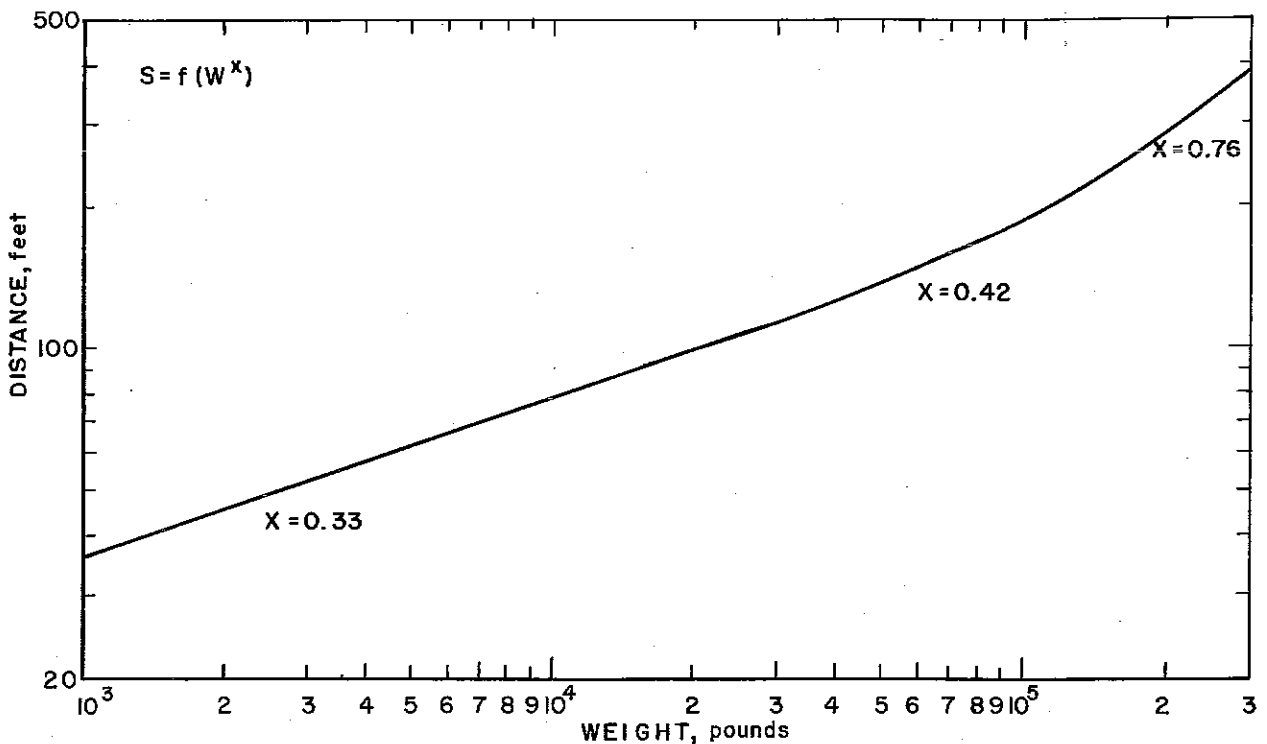

FIGURE 20. - Plot of American Table of Distances Showing Three Values of the Exponent in the Equation $S = F(W^x)$.

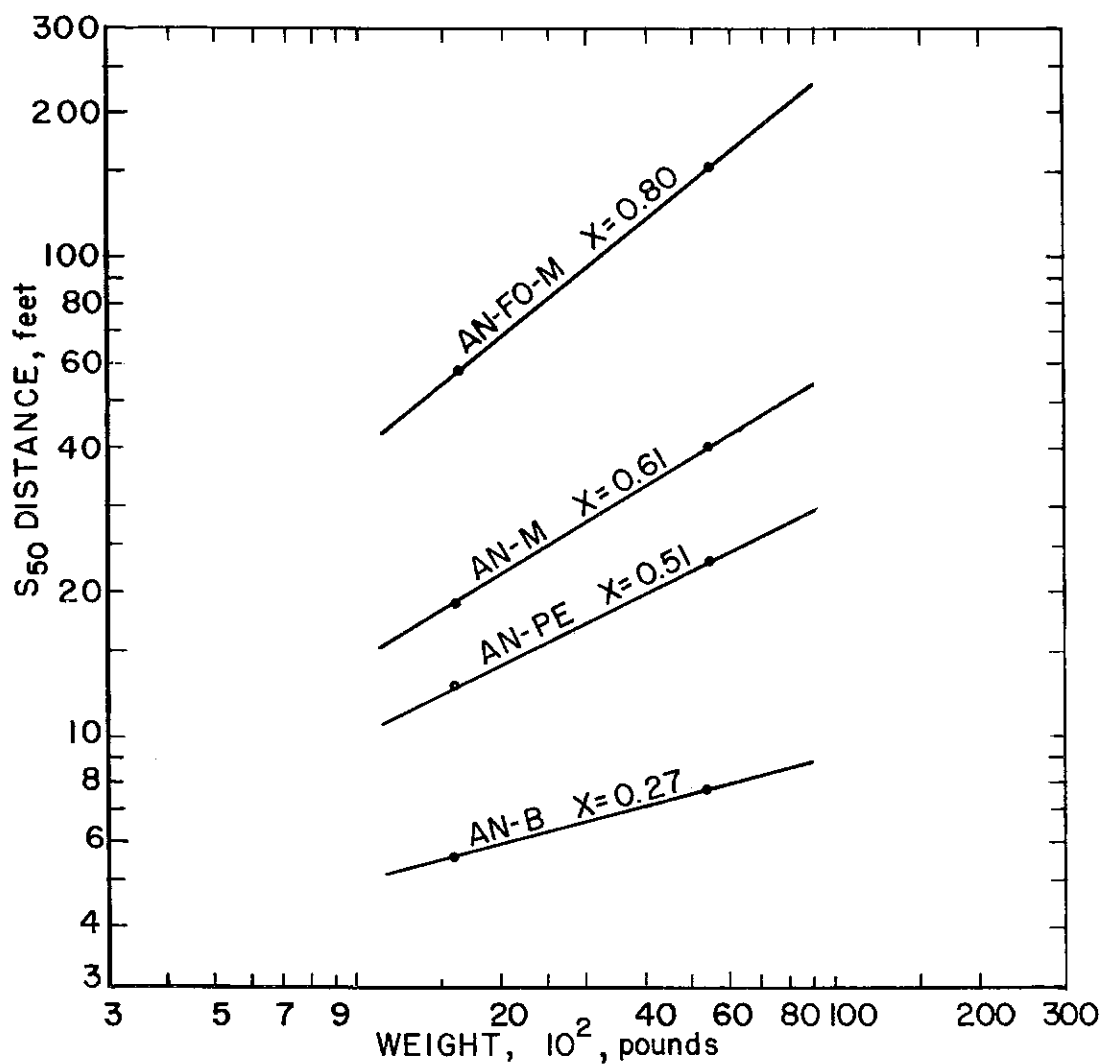

FIGURE 21. - Plots of S_{50} Values Versus Charge Weights.

acceptor and the near-plane wave initiation of the donor. The larger exponents found in this investigation would tend to support the conclusion that such a simulation was in fact achieved. The increase in required distances for large stores, suggested by larger exponents, may not be unreasonable if one considers the complexities of the initiation process.

It is generally agreed that initiation under these circumstances is largely controlled by the impact of particles or fragments from the container or from the explosive itself--that pure airblast, free of particles, is relatively inefficient in effecting sympathetic detonation. The initiating ability of the particles and fragments will be largely a function of their velocity for any given size or mass. This velocity, as was shown in phase 1 and substantiated by data in this investigation, increases in the early stages of flight as a result of acceleration by the high-pressure detonation products and is maintained at a high value over a considerable distance. The probability that a second charge will be initiated is, of course, a function of its

size, being related to the probability of its being hit by fragments of sufficient pattern density and of sufficient velocity. Thus, there exists a rather complicated relationship between donor and acceptor sizes and sympathetic detonation distances, and the fact that the relationship involves something higher than the one-third power, characteristic of airblast alone, does not appear to be unreasonable.

Table 3 showed a relative ordering of the explosive materials in terms of their sensitivities. Thus, for donors with a given face material, there was a consistent change from AN to AN-FO to dynamite. Interestingly enough, the dynamite with polyethylene-faced donors gave about the same S_{50} distance as AN-FO with metal-faced donors, and AN-FO with polyethylene-ended donors gave the same S_{50} distance as AN with metal-ended donors. These comparisons illustrate the extreme importance of missiles in the initiation of sympathetic detonation, yet the missile problem can be easily controlled by barricades.

The results for the bagged AN-FO charges were unexpected; the S_{50} values were found to be about 50 percent greater than for the bulk material. Study of some of the Fastax pictures taken of these shots and review of the oscillograms obtained with continuous probes in the charges suggest an explanation. The cause probably lies in the interplay between the initiation mechanism and the physical character of the two kinds of acceptor charges. In the case of the bulk charge, a reasonably flat and uniform surface is presented to the shock and fragments, and no large voids exist in the mass of material. In contrast, large voids, which provide potential paths for penetration of fragments into the center, are present in the pile of bagged material. Under conditions of marginal initiation, the confinement of the incipient reaction centers by the surrounding pile mass would facilitate a deflagration-to-detonation transition. The importance of such a transition in the initiation process was discussed at some length in the report covering phase 1. Oscillograms from continuous detonation probes clearly illustrate the internal initiation of detonation and its instability. In figure 22, two oscillograms are presented. Two probes were employed in each case, one on the axis and one off the axis. The polarity of the signal from the axial probe was reversed so that it gave an increasing signal with the progress of the detonation wave while the off-axis probe gave a decreasing signal. The two traces in figure 22A show the rapid development of a relatively stable detonation in a 60-inch AN-FO donor initiated by the plane-wave system. In figure 22B, the results of two similar probes in a pile of bagged AN-FO are shown. Here, in contrast, the two traces show a great deal of irregularity with initiation within the pile, as evidenced by the rapid change in signal. Ultimately a relatively steady detonation, having a velocity of about 4 mm/ μ sec, is indicated.

All of the distances given in this report are for an estimated 50 percent probability of initiation. The conversion of these distances to safe separation distances requires an estimate of the probability function. This estimate is frequently made using multiples of the standard deviation of the population. The estimate of the standard deviation is of uncertain accuracy when one employs the up-and-down method, and the estimate is especially inaccurate when only a few trials are involved.

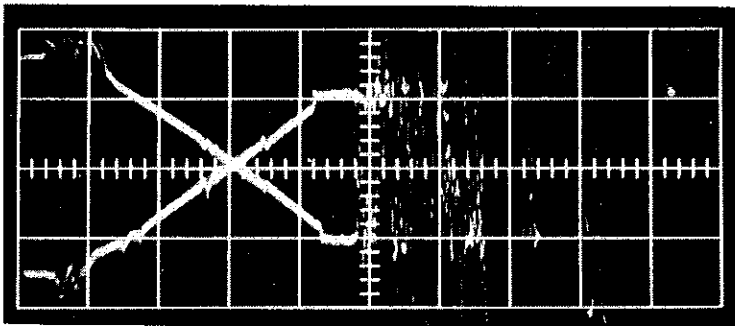

A

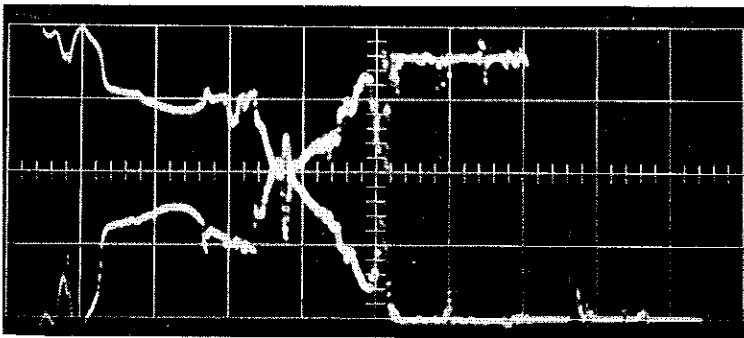

B

FIGURE 22. - Oscillograms for Continuous Probes for Detonation Velocity. A, Stable detonation in 60-inch AN-FO donor; B, delayed initiation and unstable detonation in bagged AN-FO.

The up-and-down method deliberately concentrates the test around the median to give an efficient estimate of the median. At the same time, the method necessarily sacrifices accuracy in estimating standard deviation. There is no efficient way of estimating standard deviations, short of conducting a large number of trials. To make the best estimate possible, as in phase 1, the up-and-down results from all the series were normalized to a set of artificial levels and the standard deviation for the population was estimated by the method shown in appendix A. The value of 0.043 log units is in fair agreement with the value of 0.048 obtained in the phase 1 estimates. This is somewhat lower than the 0.06 log units that was assumed for the standard deviation in the initial design of the experiment. It would appear that the gap interval of 0.12 log units may be somewhat more than the recommended 2σ , if these two estimates are valid. If so, this suggests some

additional uncertainty in the estimated S_{50} values derived in the individual up-and-down series. However, the safety factors usually applied to such data should provide reasonable protection. A 40-percent increase in S_{50} values was recommended following the phase 1 study; it would appear that this is still a good safety factor, being at least 3σ , or perhaps 4σ , removed from the median value, corresponding to a probability of the order of 1 in 1,000.

For a 1,600-pound store, corresponding to the 40-inch charges in this study, the American Table of Distances recommends the separation of 43 feet barricaded, or 86 feet unbarricaded, using the factor of 2. In phase 2, one initiation was obtained at 69 feet with dynamite and a donor having a polyethylene end, and two initiations were obtained at about 159 feet with a metal-ended donor. On the other hand, barricades reduced the initiation distance for AN-FO to about one-seventh of the unbarricaded distance. If this factor of 7 were the same for dynamite (and it might be larger), the unbarricaded data suggest a considerable safety factor in the American Table of Distances for barricaded stores of dynamite.

Attention was drawn in the report on phase 1 to the table of separation distances given in the Du Pont Blasters' Handbook (2). For 1,600 pounds of dynamite, a separation distance of about 64 feet reportedly should give 100-percent failures but, as previously noted, one initiation out of three was obtained at 69 feet. The corresponding comparisons for the data given for Nitramon and Nitramex are difficult to make because the data were obtained with the blasting agents contained in metal cans, but the suggested safe distance of 13 to 14 feet seem to be too small on the basis of the phase 1 and phase 2 results.

Finally, the data would seem to be adequate to allow for the development of a series of tables for safe separation of AN, AN-FO, and dynamite. For the latter there appears to be no need to revise the existing American Table of Distances for barricaded stores, but a change should be made in the recommendation for unbarricaded stores. The data could only be improved significantly by many trials with still larger charges. In the two field programs, phase 1 and phase 2, about a half-million pounds of AN, AN-FO, and dynamite were shot, together with nearly 50,000 feet of Primacord. The summary of the materials used is given in appendix B. To increase the charge size to 80 inches would mean employing acceptor and donor charges of 12,000 pounds each. Besides the cost, such charges impose severe limitations on site selection. Thus, it is believed that the solution is to make the best use of existing data to develop tables of distances. It is clear that such tables can be developed with much more confidence now than before these two studies were undertaken.

ACKNOWLEDGMENTS

The continued support of the Manufacturing Chemists' Association and the Institute of the Makers of Explosives and of individual contributing companies, as suppliers and users of explosives and blasting agents, is greatly appreciated. The ad hoc committee that was instrumental in conception and development of the earlier program again functioned under the chairmanship of Harrie W. Backes, Monsanto Company, St. Louis, Mo. Other members included William J. Taylor, Atlas Chemical Industries, Inc., Wilmington, Del.; S. J. Porter, representing the Chemical Department, Gulf Oil Corp., Kansas City, Mo.; and Frank A. Loving, E. I. du Pont de Nemours & Co., Inc., Martinsburg, W. Va.

The assistance during the early phases of the program of C. H. Winning of the Eastern Laboratories of Du Pont and the full cooperation of B. A. Semb and his staff of the Barksdale plant of Du Pont, who supplied materials and manpower, are gratefully acknowledged. The generosity of Julius Meszaros and Ralph Reisler of the Explosives Kinetics Group of the Ballistic Research Laboratories, Aberdeen Proving Ground, Md., who supplied self-recording pressure gages and data reduction, is appreciated.

The following companies provided either financial support or contributed essential materials to the program: Allied Chemical Corp., New York, N. Y.; American Cyanamid Co., Wayne, N. J.; The Anaconda Co., New York, N. Y.; Apache Powder Co., Benson, Ariz.; Armour Agricultural Chemical Co., Atlanta, Ga.; Atlas Chemical Industries, Inc., Wilmington, Del.; Canadian Industries, Ltd., Montreal, Quebec, Canada; Commercial Solvents Corp., Terre Haute, Ind.;

The Consolidated Mining & Smelting Co. of Canada, Ltd., Trail, British Columbia, Canada; E. I. du Pont de Nemours & Co., Inc., Wilmington, Del.; The Ensign-Bickford Company, Simsbury, Conn.; Chemical Department, Gulf Oil Corp., Kansas City, Mo.; Hercules Powder Co., Wilmington, Del.; Kennecott Copper Company, New York, N. Y.; Monsanto Co., St. Louis, Mo.; Phillips Petroleum Co., Bartlesville, Okla.; U.S. Steel Corp., Pittsburgh, Pa.; and White Pine Copper Co., White Pine, Mich.

REFERENCES

1. Dixon, W. J. The Up-and-Down Method for Small Samples. *J. Am. Stat. Assoc.*, v. 60, December 1965, pp. 967-978.
2. Dixon, W. J., and F. M. Massey, Jr. *Introduction to Statistical Analysis*. McGraw-Hill Book Co., Inc., New York, 2d ed., 1957, 488 pp.
3. E. I. du Pont de Nemours & Co., Inc. *Blasters' Handbook*. Wilmington, Del., 14th ed., 1958, p. 142.
4. Institute of Makers of Explosives. *American Table of Distances for Storage of Explosives (Pamphlet 2)*. New York, rev. Sept. 30, 1955.
5. Kingery, C., and B. Pannill. *Peak Over-Pressure Versus Scaled Distance for TNT Surface Bursts (Hemispherical Charges)*. Ballistics Research Laboratory Memorandum Rept. 1518, April 1964, p. 15.
6. Munroe, Charles E., and J. E. Tiffany. *Physical Testing of Explosives at the Bureau of Mines Explosives Experiment Station, Bruceton, Pa.* BuMines Bull. 346, 1931, pp. 59-60.

APPENDIX A.--ESTIMATE OF STANDARD DEVIATION OF UP-AND-DOWN RESULTS

To increase the number of results that could be employed in estimating the standard deviation, all of the usable up-and-down results were normalized to a common series of intervals as shown in table A-1. For each series level, b was chosen as the lowest level at which all trials gave positive results. The computations, following the original version,¹ are given in the table as well. Calculation of the median value was necessary to convert graphically the statistic M to an estimated standard deviation. The more commonly used formulas are unsatisfactory for $M < 0.3$. The estimate of 0.43 is in reasonable agreement with the value of $0.48 \log_{10}$ units estimated for the results in phase 1.

¹Statistical Research Group, Princeton University. Statistical Analysis of a New Procedure in Sensitivity Experiments, AMP Rept. 101.1R, SRG-P No. 40, July 1944, 58 pp. (Available in microfilm or camera copy from the Library of Congress. The order number is PB 23709.)

TABLE A-1. - Normalized up-and-down results

(Y = acceptor initiated; N = acceptor failed to initiate)

Level	Series 1	Series 2	Series 3	Series 4	Series 5	Series 6	Series 7	Series 8	Series 9	Series 10	$\sum Y$	$\sum N$	n	$\sum ni$	ni^2
a		Y	Y				Y		Y		4	0			
b	Y Y Y	Y Y Y	Y Y Y	Y Y Y	Y Y	Y	Y Y	Y	Y		19	0	0	2	0
c	N N N	N N N	Y N Y	N N Y	N N	N N	N Y N	N Y Y	N		6	18	18	1	18
d			N		N	N	N	N N			0	5	5	0	0
e					N						0	1	23	18	18
											29	24			

Estimate of the mean

$$\begin{aligned}
 m &= |d| - d \left(\frac{\sum ni}{N} + \frac{1}{2} \right) \text{ where } N = \sum n \\
 &= |d| - d \left(\frac{18}{23} + \frac{1}{2} \right) \\
 &= |d| - 1.28 d
 \end{aligned}$$

Estimate of the standard deviation

$$\begin{aligned}
 M &= \frac{N(\sum ni^2) - (\sum ni)^2}{N^2} \\
 &= \frac{23(18) - (18)^2}{(23)^2} \\
 &= \frac{414 - 324}{529} \\
 &= \frac{90}{529} = 0.17
 \end{aligned}$$

From graph No. 2¹

$$\sigma = .36 d = 0.043 \text{ log units}$$

¹Work cited in footnote 1 (appendix).

APPENDIX B.--MATERIALS USED

Material	Phase 1	Phase 2	Total
Explosive, pounds:			
AN.....	73,300	91,300	164,600
AN-FO:			
Acceptor.....	15,500	48,400	63,900
Donor.....	69,300	176,800	246,100
Bagged.....	-	12,600	12,600
	84,800	237,800	322,600
Dynamite.....	-	22,400	22,400
Total.....	158,100	351,500	509,600
Primacord.....feet..	~20,000	~30,000	~50,000

