

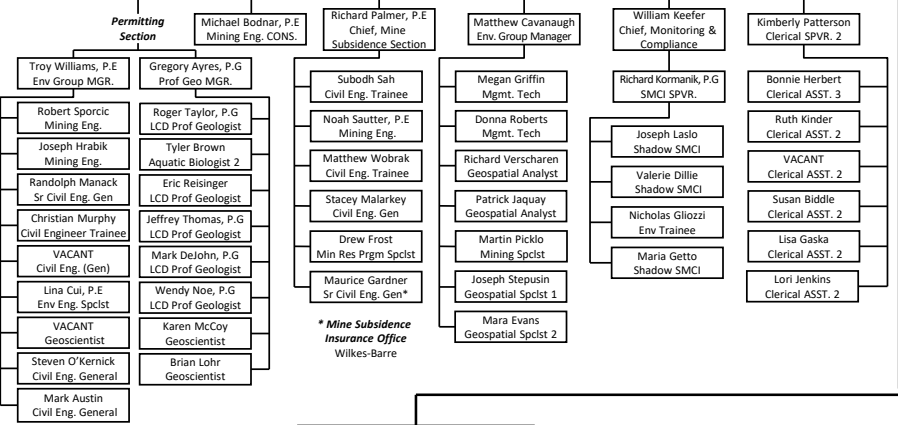

BUREAU OF DISTRICT MINING OPERATIONS
DIRECTOR
Randy Shustack

Effective 9/9/2023

California District Mining Office
 Samuel Faith, Manager



Pottsville District Mining Office
 Michael Kutney, Acting Manager

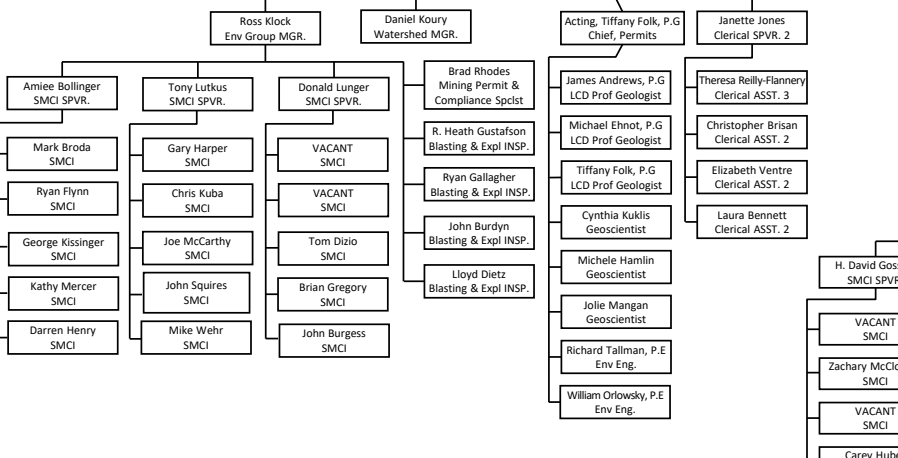

Cambria/New Stanton District Mining Office
 David Thomas, Manager

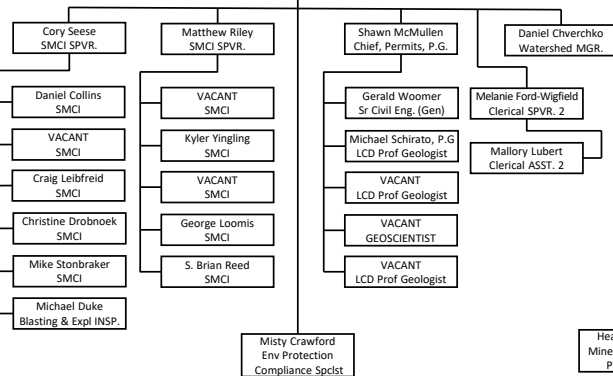

New Stanton District Office
 Chad Meyer, Env Prgm Manager

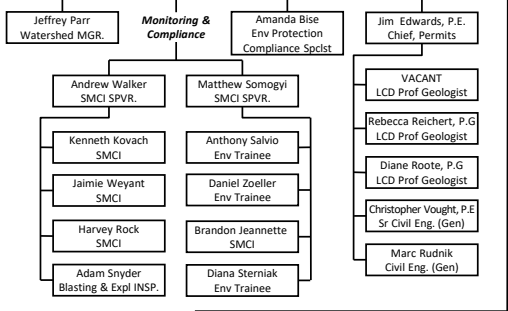

DIRECTOR'S OFFICE
RANDY SHUSTACK,
BUREAU DIRECTOR

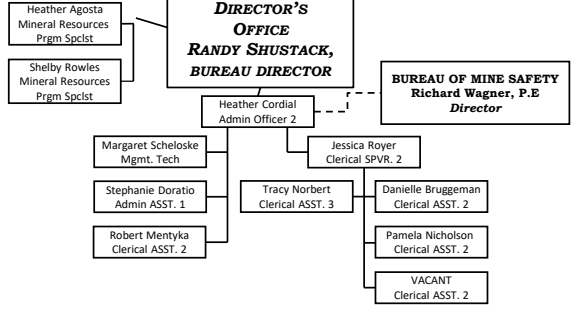

BUREAU OF MINE SAFETY
 Richard Wagner, P.E. Director

Moshannon/Knox District Mining Office
 Paul Kephart, Manager

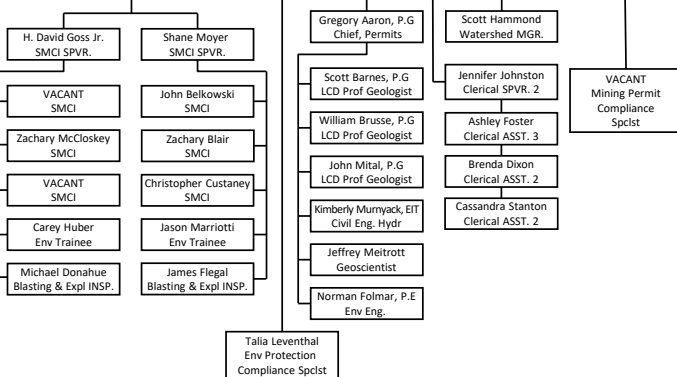

Knox District Office
 Christopher Yeakle, Env Prgm Manager

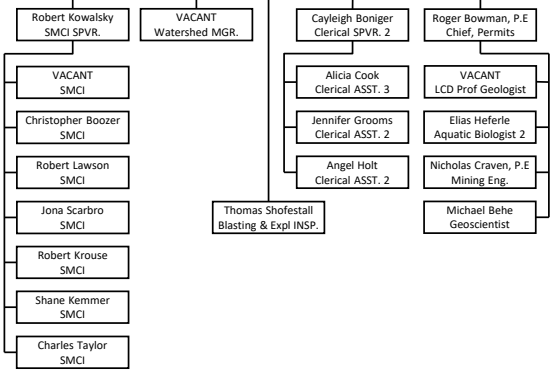

Talia Leventhal Env Protection Compliance Spclst

