

LEGEND
 PUMP
 AERATION BLOWER

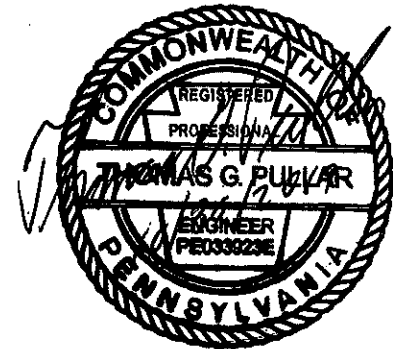

FIGURE 2
LEACHATE TREATMENT SCHEMATIC

LTP MODIFICATIONS
 KEYSTONE SANITARY LANDFILL, INC.
 DUNMORE BOROUGH, THROOP BOROUGH
 LACKAWANNA COUNTY, PENNSYLVANIA

CHECKED BY:	TGP
PROJECT NO:	091018.064
DRAWN BY:	RLH
DATE:	01/21/19
DRAWING SCALE:	NOT TO SCALE

HEADQUARTERS
 PHILADELPHIA REGION
 P. O. Box 468
 6917 Old Easton Road
 Pipersville, PA 18947



APPALACHIAN
 REGIONAL OFFICE
 P. O. Box 794
 8000 Coombs Farm Drive
 Morgantown, WV 26505

EARTHRES
 ENGINEERING FOR SUCCESS™
 www.earthres.com

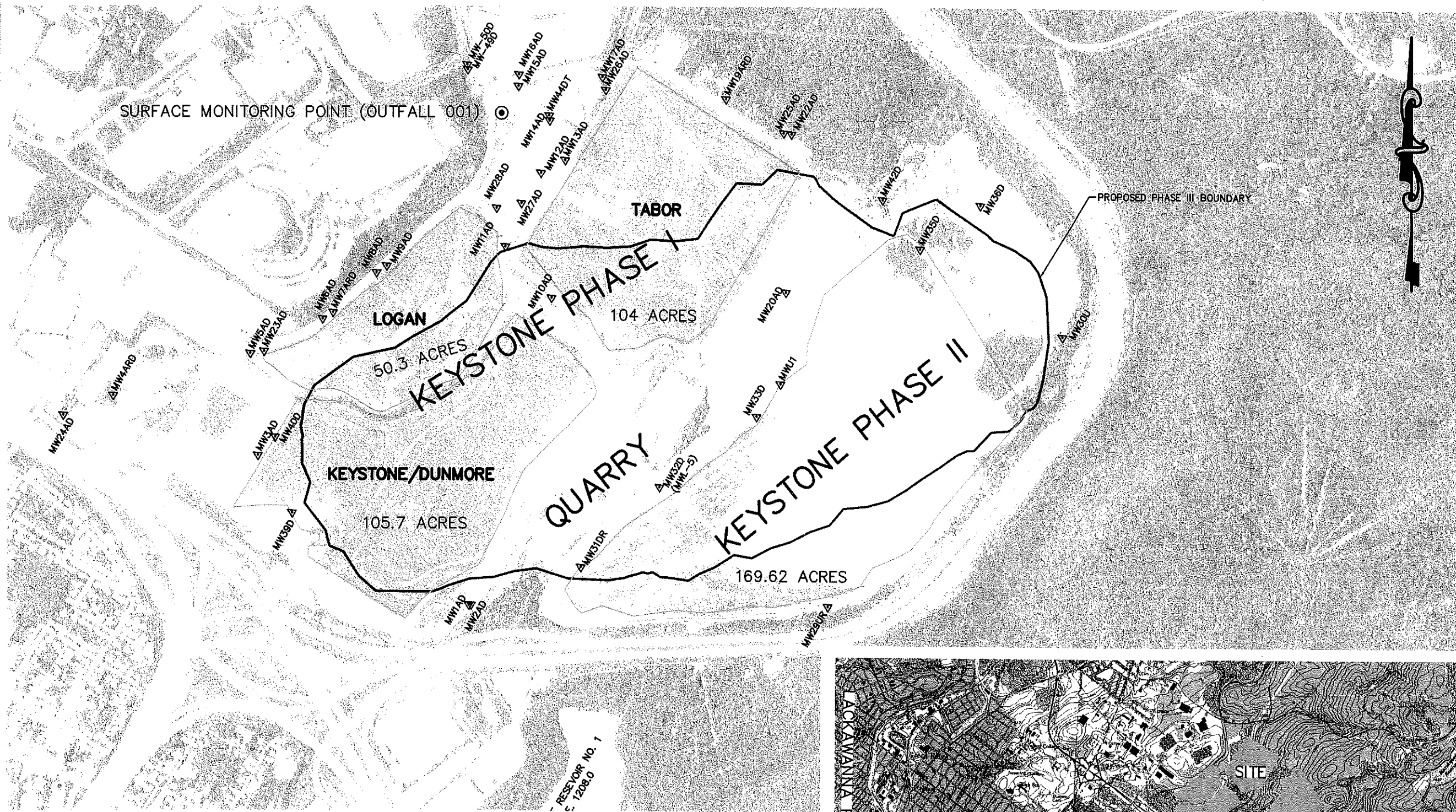
**FIGURE 3
SITE PLAN**



LEGEND

-  PERMIT BOUNDARY
-  SURFACE MONITORING POINT
-  MONITORING POINT

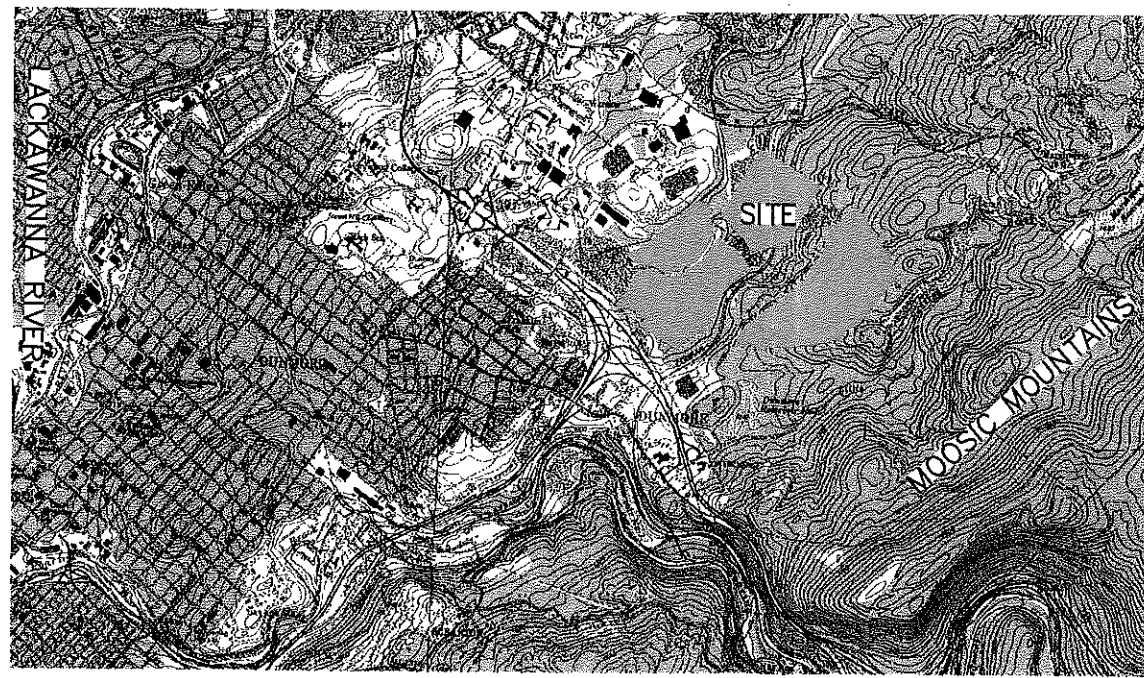
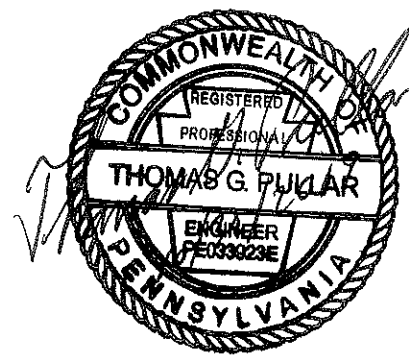

INSET SCALE: 1"=5,000'

HEADQUARTERS
PHILADELPHIA REGION
P. O. Box 468
6912 Old Easton Road
Pipersville, PA 18947

APPALACHIAN
REGIONAL OFFICE
P. O. Box 794
8000 Coombs Farm Drive
Morgantown, WV 26505



EARTHRES
ENGINEERING FOR SUCCESS™
www.earthres.com

DRAWN BY: JJB	CHECKED BY: MSW
DATE: 09/19/19	PROJECT NO: 091018.064
DRAWING SCALE: 1"=1,000'	

FIGURE 3
SITE PLAN WITH MONITORING LOCATIONS

KEYSTONE SANITARY LANDFILL
THROOP AND DUNMORE BOROUGH
LACKAWANNA COUNTY
PENNSYLVANIA

**FIGURE 4
FACILITY PLAN LAYOUT**

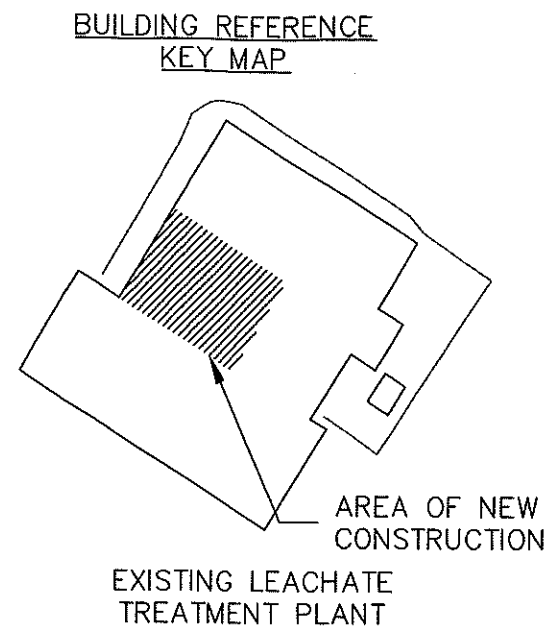
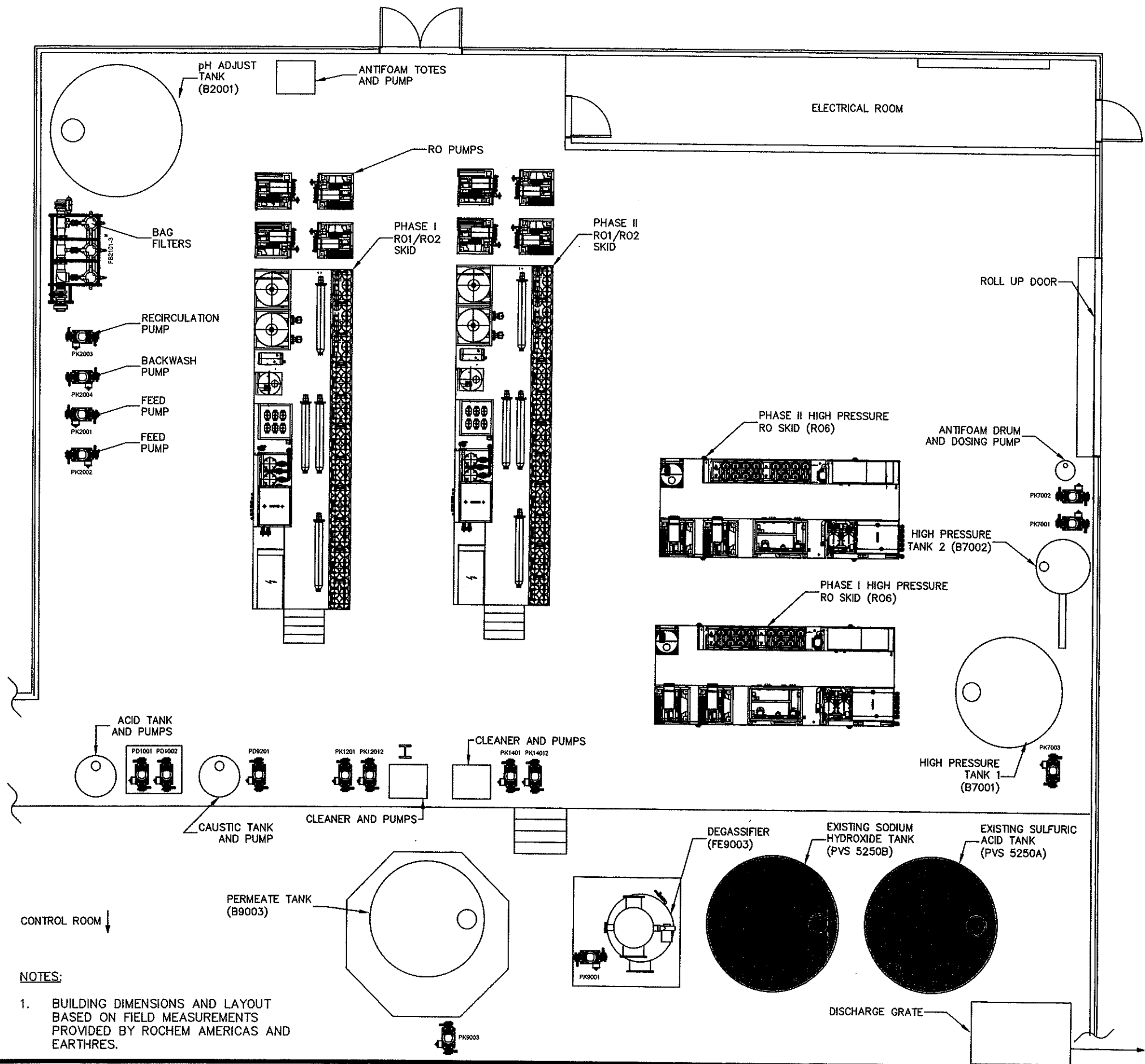

NOTES:

- BUILDING DIMENSIONS AND LAYOUT BASED ON FIELD MEASUREMENTS PROVIDED BY ROCHEM AMERICAS AND EARTHRES.

PREPARED FOR:

www.earthres.com

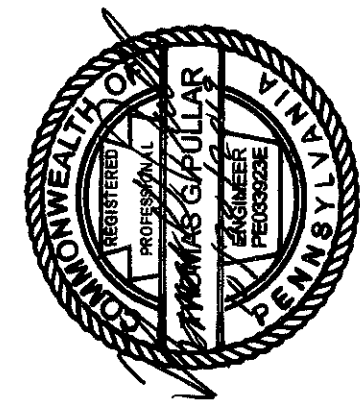

HEADQUARTERS
PHILADELPHIA REGION
P. O. Box 468
6912 Old Easton Road
Pipersville, PA 18947

APPALACHIAN REGIONAL OFFICE
P. O. Box 794
8000 Coombs Farm Drive
Morgantown, WV 26505

EARTHRES
ENGINEERING FOR SUCCESS™

CHECKED BY:	TGP
PROJECT NO:	091018.064
DRAWN BY:	RLH
DATE:	01/21/19
DRAWING SCALE:	NOT TO SCALE

FIGURE 4
FACILITY PLAN

LTP MODIFICATIONS
KEYSTONE SANITARY LANDFILL, INC.
DUNMORE BOROUGH, THROOP BOROUGH
LACKAWANNA COUNTY, PENNSYLVANIA

ATTACHMENT B
WASTEWATER EQUIPMENT INFORMATION

B1

ROCHEM EQUIPMENT

422 Pipe & Instrument Diagram (P+I)

The P+I diagram is part of the complete manual on CD-ROM. It makes no sense to have a too small copy in this operation manual.

Legend to the Pipe & Instrument Diagram:

Letters indicate the FUNCTION of the component:	
B	tank
FC	cartridge filter
FD	deacidification filter
FE	stripper
FM	ST module or module block
FS	Sandfilter
WE	heater
PD	dosing pump / chemical pump
PK	centrifugal pump
PP	plunger pump
RK	compressor/fan
RW	stirrer
S	hose
SP	pulsation damper
TA	external tank
V	globe valve or check valve
VE	solenoid valve
VF	spring safety valve
VK	ball valve
VM	membrane valve, manually operated
VP	membrane valve, pneumatically operated
VR	non-return device
VS	motor control valve
VV	valve (general)
<i>Measurements:</i>	
F....	flow

G	position
L	level
N / C	conductivity
O	current
P	pressure
T	temperature
U	result from other quantities
Y / A	pH transmitter
Second position and higher	
A	Alarm
C	Control
D	Difference
F	Relation
I	Display / Indication on sensor
O	limit position
Q	Quantity, Sum
R	registration
S	switch
Z	lock
<i>Example:</i>	
FIRC	Flow measurement by transmitter, controlled by signal, with display, registration and controlling function
FI	Flow measurement, only local display

B-B

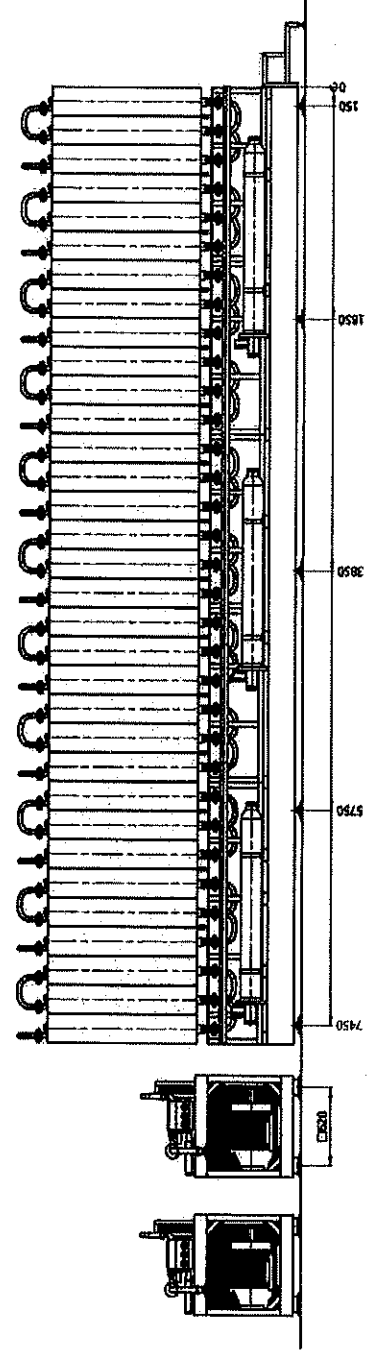

A-A

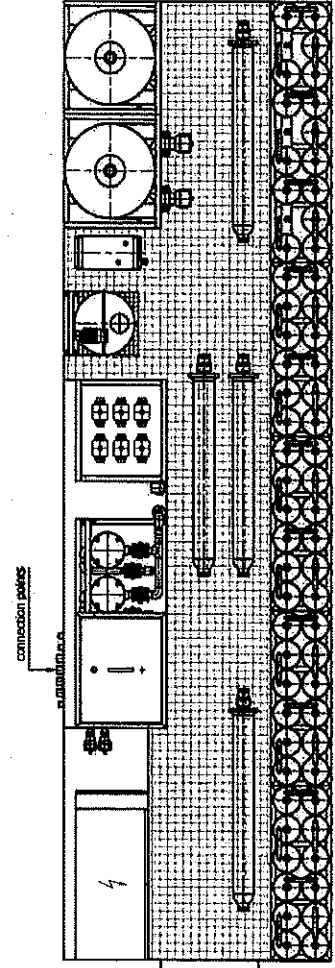
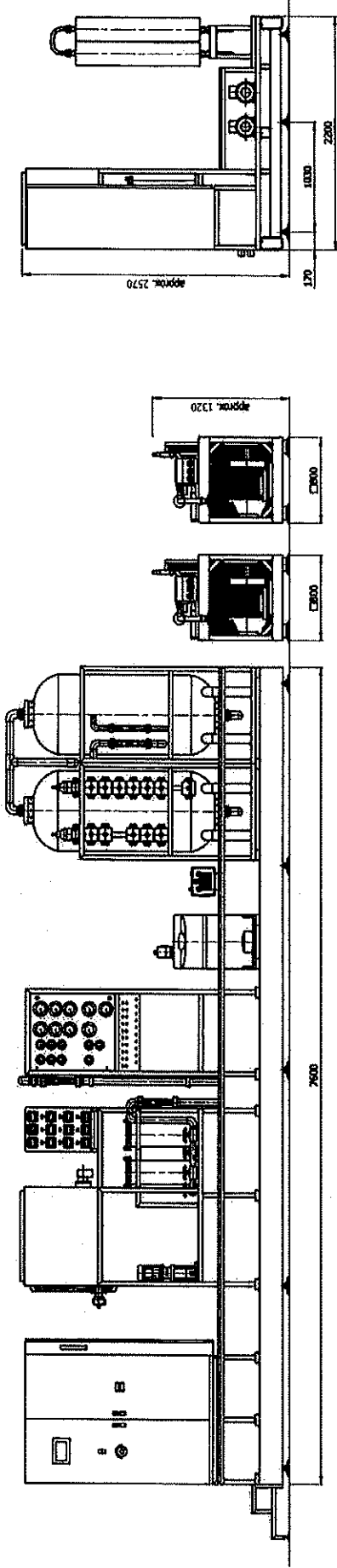

B
A

B
A

1. The drawings are to be read in accordance with the following notes:
 2. The drawings are to be read in accordance with the following notes:
 3. The drawings are to be read in accordance with the following notes:
 4. The drawings are to be read in accordance with the following notes:
 5. The drawings are to be read in accordance with the following notes:
 6. The drawings are to be read in accordance with the following notes:
 7. The drawings are to be read in accordance with the following notes:
 8. The drawings are to be read in accordance with the following notes:
 9. The drawings are to be read in accordance with the following notes:
 10. The drawings are to be read in accordance with the following notes:

Project	Keystone	Sheet	220
Client	Keystone	Scale	
Design	Keystone	Unit Type	600W 13 plus 40/5
Drawn	Keystone	Contract No.	612.B3134A-1a
Checked	Keystone		
Approved	Keystone		
Project	Keystone		
Client	Keystone		
Design	Keystone		
Drawn	Keystone		
Checked	Keystone		
Approved	Keystone		
Project	Keystone		
Client	Keystone		
Design	Keystone		
Drawn	Keystone		
Checked	Keystone		
Approved	Keystone		

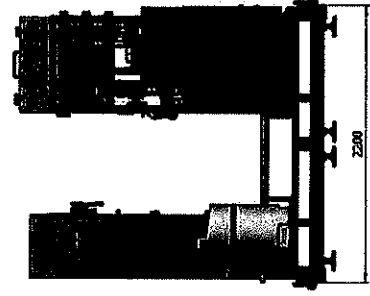
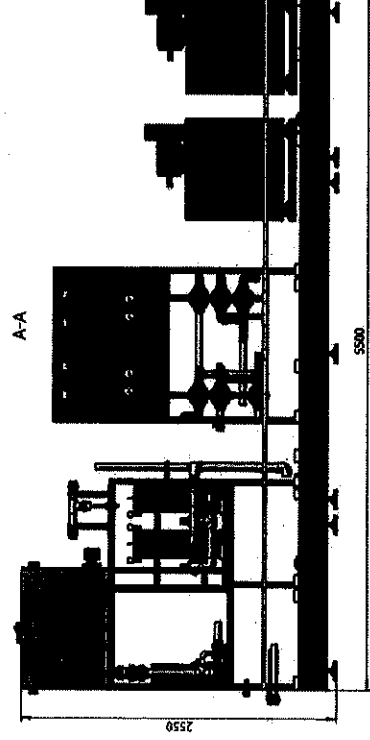
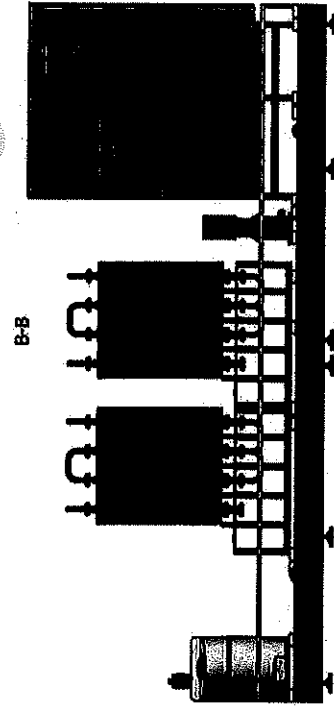

connection points

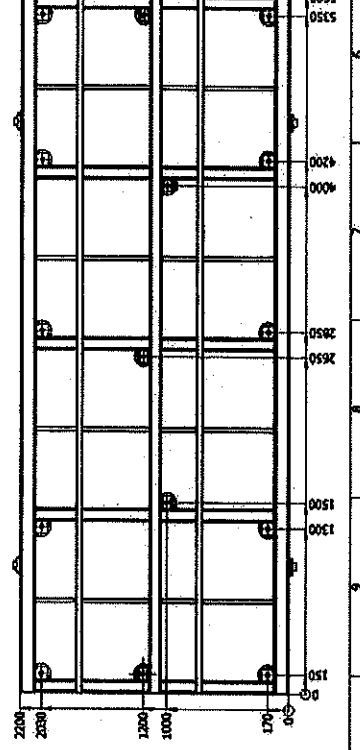
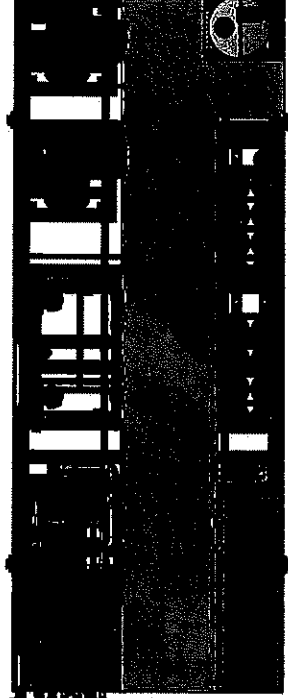

Foundation plan (1 : 20)

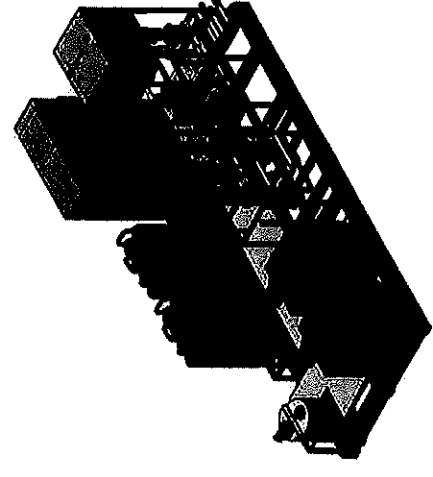

Isometric drawing (1:30)

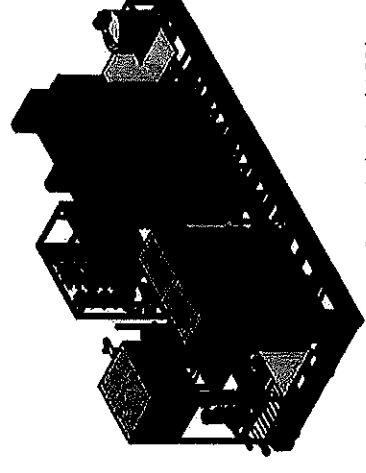
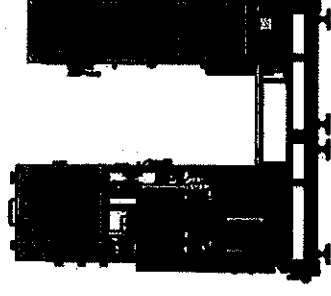

Isometric drawing (1:30)

		Scale	1:20
LAYOUT Unit Type: ROLV 9542 HPTS 16 HP-stage		Sheet No.	612.B3185-1a
Project	Keyframe	Rev.	1
Client	Contract	Rev.	1
Design	Rev.	Rev.	1
Check	Rev.	Rev.	1
Issue	Rev.	Rev.	1

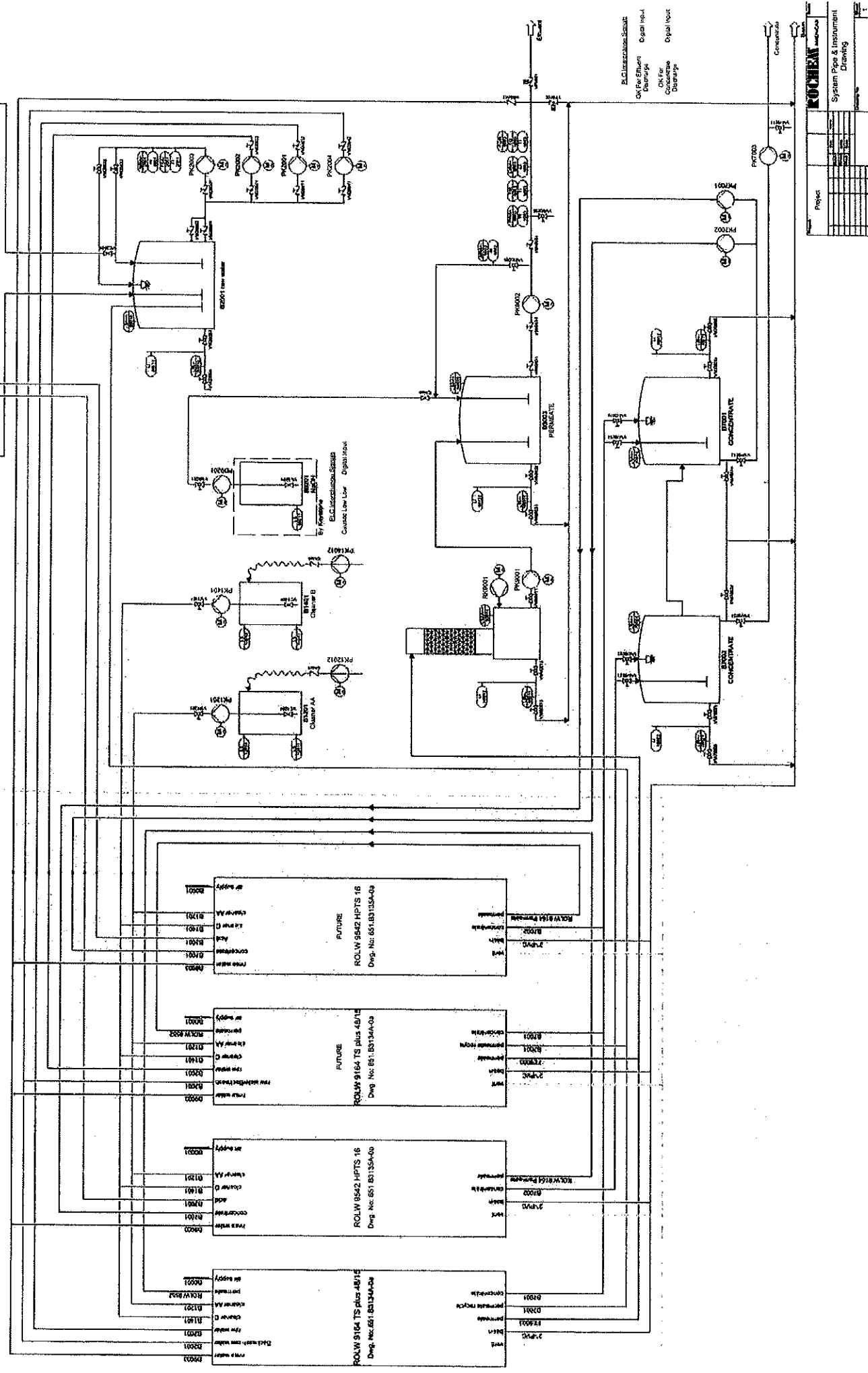
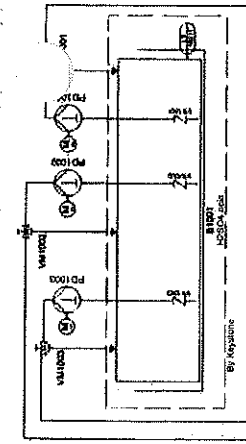
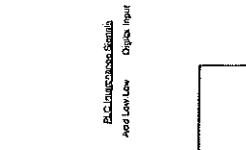
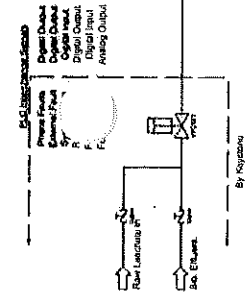

ELC (Electrical Control)
 OK For Elevation
 OK For Damage
 OK For Construction
 OK For Discharge

Project

Project Name	
Project No.	
Project Date	
Project Location	
Project Description	

System Pipe & Instrument
 Drawing

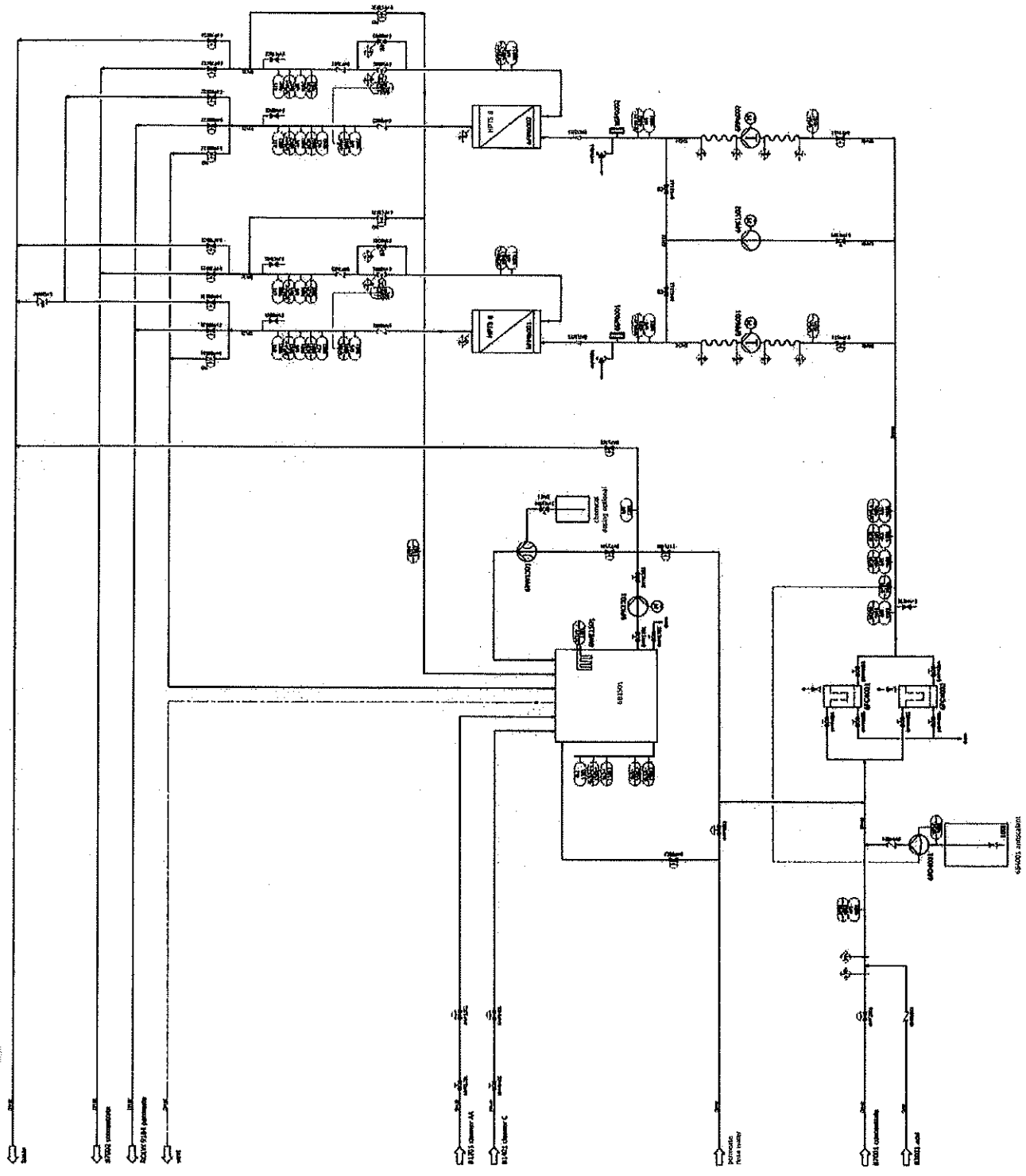

NO.	REVISION	DATE	BY
1	INITIAL DESIGN	1973.10	...
2
3
4
5
6
7
8
9
10

Comment: Check for conductivity
 of all the joints.
 A check for loose
 connections.

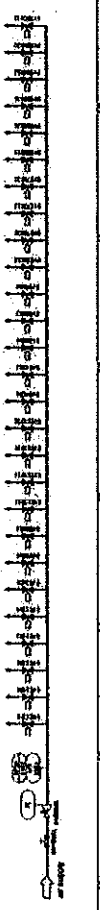

6518135A-01
 10/1973

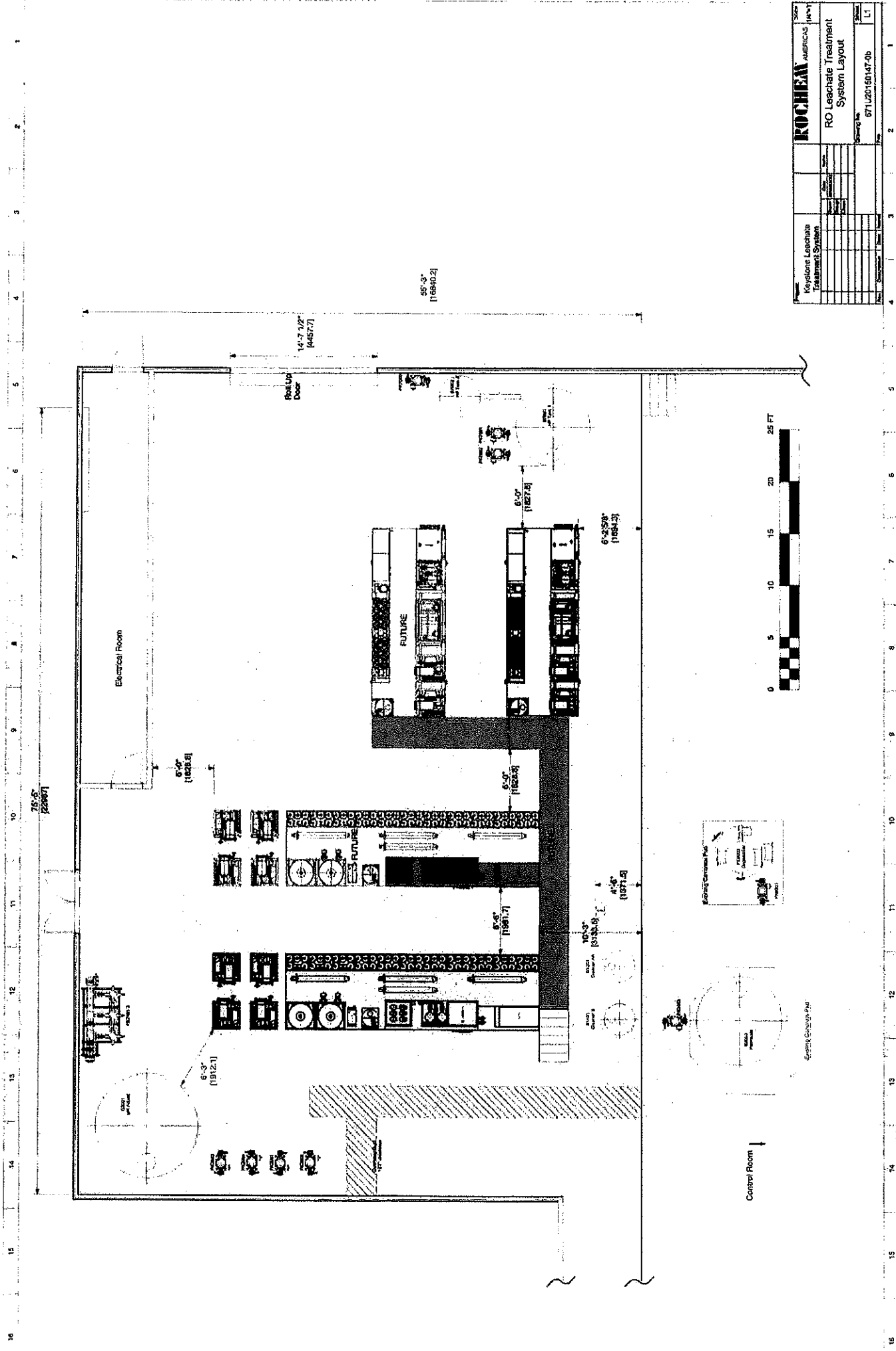

KeyStone Leachate Treatment System		ROCHEM AMERICA INC. (REV)	
Project Name		RO Leachate Treatment System Layout	
Project No.		671120150147-0b	
Revision		L1	
Date			
Author			
Checker			
Approver			

B2

PUMP SCHEDULE

Project: Keystone

Rev.: 2

Date: 22-Mar-18

Pump List

Tag	Manufacturer	Model	Flow		Pressure		P2 Power			
			gpm	m3/hr	psi	bar	HP	KW	Voltage	Amps
PK2001	Grundfos	CRN15-1	62.5	14.2	24.2	1.7	2	1.5	3 x 460Y V	3.1
PK2002	Grundfos	CRN15-1	62.5	14.2	24.2	1.7	2	1.5	3 x 460Y V	3.1
PK2003	Grundfos	CRN45-1-1	200	45.5	10	0.7	7.5	5.6	3 x 460Y V	9.1
PK2004	Grundfos	CRN20-1	72.5	16.5	29	2.0	3	2.2	3 x 460Y V	3.9
PK7001	Grundfos	CRN10-3	44	10.0	51	3.5	3	2.2	3 x 460Y V	3.9
PK7002	Grundfos	CRN10-3	44	10.0	51	3.5	3	2.2	3 x 460Y V	3.9
PK9001	Grundfos	CRN32-01	116	26.4	33.8	2.3	5.5	4.1	3 x 460Y V	7.5
PK9002	Grundfos	CRNE32-1	126	28.6	5.2	0.4	5.5	4.1	3 x 460Y V	6.1
	Grundfos	CRN20-1	70.6	16.3	26.2	1.8	3	2.2	3 x 460Y V	3.9

Tag	Manufacturer	Model	Flow		Pressure		P2 Power			
			gpm	m3/hr	psi	bar	HP	KW	Voltage	Amps
PK1201	Finish Thompson	PFM-48"	8.5	1.9	13	0.9	1.3	1.0	1 x 230V	4.5
PK12012	Finish Thompson	PFM-40"	8.5	1.9	13	0.9	1.3	1.0	1 x 230V	4.5
PK1401	Finish Thompson	PFM-48"	8.5	1.9	13	0.9	1.3	1.0	1 x 230V	4.5
PK14012	Finish Thompson	PFM-40"	8.5	1.9	13	0.9	1.3	1.0	1 x 230V	4.5

Project: Keystone

Rev.: 2

Date: 22-Mar-18

Pump List

Dosing Pumps

All dosing pumps equipped with 4-20mA control signal and Prominent 5-wire control cable with Pause function.

Tag	Manufacturer	Model	Flow			Pressure		P2 Power		
			gph	lph	psi	bar	HP	KW	Voltage	Amps
PD1001	Prominent	Sigma 2 12017 PVT	19.9	66	145	10	0.68	0.2	3 x 230V	1.2
PD1002	Prominent	Sigma 1 12017 PVT	5.3	20	145	10	0.125	0.1	1 x 230V	0.7
PD1003	Prominent	Sigma 1 12017 PVT	5.3	20	125	10	0.125	0.1	1 x 230V	0.7
PD9201	Prominent	gamma/X 1602	0.61	2.3	232	16	0.025	0.0	1 x 230V	

B3

TANK SCHEDULE

Project: Keystone

Rev.: 1

Date: 4-Apr-18

Tank List

Tag	Manufacturer	Use	Capacity gallons	Diameter inches	Height inches	Material	Op. Weight Pounds	Max. Weight pounds
B2001	TBD	Raw Water Tank	8500	90	130	FRP	53,000	76,800
B7001	TBD	HP Working Tank	3000	90	127	FRP	15,000	27,500
B7002	TBD	HP Working Tank	3000	48	147	FRP	4,200	7,630
B9003	TBD	Effluent Storage	5500	90	216	FRP	41,500	47,265
B9201	Snyder	Cleaner Storage	350	48	55	XUPE	2,475	3,750
B1401	Snyder	Cleaner Storage	350	48	55	XUPE	2,400	3,450
Desaerator	Beauregard	Desaeration	500	60	250	FRP	-	-

ATTACHMENT C

**PREPAREDNESS, PREVENTION & CONTINGENCY (PPC) PLAN
(W/FORM L & SPR)**

(Submitted under separate cover)

