



Pennsylvania  
Department of  
Environmental Protection

April 9, 2026

Laura Sabolyk, Senior Regulatory Advisor  
300 Frankfort Road  
Monaca, PA 15061

Re: Plan Approval PA-04-00740A  
Shell Chemical Appalachia LLC  
Shell Polymers Monaca  
Potter and Center Townships  
Beaver County

Dear Laura Sabolyk:

This is in response to your request for an Air Quality Plan Approval Extension. After careful review, your request for a 180-day extension has been approved. The expiration date of this extension is October 28, 2026.

In order to continue to operate lawfully after the 180-day extension period, you must have either:

- Applied for and obtained an extension for an additional 180-day period; provided that you apply at least **30 days prior to expiration**, include the appropriate fee, and update your Air Pollution Control Act Compliance Review Form.
- Met all of the requirements of the Plan Approval and received a Title V Operating Permit. Forms, instructions and fee information are available through our website at [www.dep.pa.gov](http://www.dep.pa.gov).

If one of the above actions is not completed and the Plan Approval expires, a new application for a Plan Approval may be required.

If you have any questions regarding this matter, please contact me by at 412.442.4028 or [asandy@pa.gov](mailto:asandy@pa.gov).

Sincerely,

Alexander Sandy/AS  
Air Quality Engineering Specialist  
Air Quality Program

Enclosure

cc: File 04-00740A  
Operations (S. Wiedemer)  
OnBase



**COMMONWEALTH OF PENNSYLVANIA  
DEPARTMENT OF ENVIRONMENTAL PROTECTION**

Southwest Regional Office

Air Quality Program



*PLAN APPROVAL PERMIT # 04-00740A*

*SHELL CHEM APPALACHIA LLC*

*Potter Township, Beaver County*

Issue Date: June 18, 2015

Revision Date: April 7, 2026

Revision Type: Extension

Expiration Date: October 28, 2026



**COMMONWEALTH OF PENNSYLVANIA  
DEPARTMENT OF ENVIRONMENTAL PROTECTION  
AIR QUALITY PROGRAM**

**PLAN APPROVAL**

Issue Date: June 18, 2015

Effective Date: April 28, 2026

Revision Date: April 7, 2026

Expiration Date: October 28, 2026

Revision Type: Extension

In accordance with the provisions of the Air Pollution Control Act, the Act of January 8, 1960, P.L. 2119, as amended, and 25 Pa. Code Chapter 127, the Owner, [and Operator if noted] (hereinafter referred to as permittee) identified below is authorized by the Department of Environmental Protection (Department) to construct, install, modify or reactivate the air emission source(s) more fully described in the site inventory list. This Facility is subject to all terms and conditions specified in this plan approval. Nothing in this plan approval relieves the permittee from its obligations to comply with all applicable Federal, State and Local laws and regulations.

The regulatory or statutory authority for each plan approval condition is set forth in brackets. All terms and conditions in this permit are federally enforceable unless otherwise designated as "State-Only" requirements.

**Plan Approval No. 04-00740A**

Federal Tax Id - Plant Code: 46-1624986-1

**Owner Information**

Name: SHELL CHEM APPALACHIA LLC  
Mailing Address: 300 FRANKFORT RD  
MONACA, PA 15061-2210

**Plant Information**

Plant: SHELL CHEM APPALACHIA/SHELL POLYMERS MONACA  
Location: 04 Beaver County 04947 Potter Township  
SIC Code: 2821 Manufacturing - Plastics Materials And Resins

**Responsible Official**

Name: NATHAN LEVIN  
Title: GEN MGR  
Phone: Email: Nathan.Levin@shell.com

**Plan Approval Contact Person**

Name: LAURA SABOLYK  
Title: SENIOR REGULATORY ADVISOR  
Phone: (724) 709 - 2906 Email: Laura.L.Sabolyk@shell.com

[Signature]



MARK R. GOROG, P.E., ENVIRONMENTAL PROGRAM MANAGER, SOUTHWEST REGION



#### Plan Approval Description

This Plan Approval is to allow the construction and temporary operation of a petrochemicals complex by Shell Chemical Appalachia LLC to be located in Potter and Center Townships, Beaver County. This Plan Approval has been modified effective December 30, 2016, to incorporate secured ERCs as emission offsets.

This Plan Approval has been modified on November 27, 2019, to begin the period of temporary operation.



## SECTION A. Table of Contents

### Section A. Facility/Source Identification

Table of Contents  
Plan Approval Inventory List

### Section B. General Plan Approval Requirements

- #001 Definitions
- #002 Future Adoption of Requirements
- #003 Plan Approval Temporary Operation
- #004 Content of Applications
- #005 Public Records and Confidential Information
- #006 Plan Approval Terms and Conditions
- #007 Transfer of Plan Approvals
- #008 Inspection and Entry
- #009 Plan Approval Changes for Cause
- #010 Circumvention
- #011 Submissions
- #012 Risk Management
- #013 Prohibition of Air Pollution
- #014 Compliance Requirement

### Section C. Site Level Plan Approval Requirements

- C-I: Restrictions
- C-II: Testing Requirements
- C-III: Monitoring Requirements
- C-IV: Recordkeeping Requirements
- C-V: Reporting Requirements
- C-VI: Work Practice Standards
- C-VII: Additional Requirements
- C-VIII: Compliance Certification
- C-IX: Compliance Schedule

### Section D. Source Level Plan Approval Requirements

- D-I: Restrictions
- D-II: Testing Requirements
- D-III: Monitoring Requirements
- D-IV: Recordkeeping Requirements
- D-V: Reporting Requirements
- D-VI: Work Practice Standards
- D-VII: Additional Requirements

Note: These same sub-sections are repeated for each source!

### Section E. Source Group Restrictions

- E-I: Restrictions
- E-II: Testing Requirements
- E-III: Monitoring Requirements
- E-IV: Recordkeeping Requirements
- E-V: Reporting Requirements
- E-VI: Work Practice Standards
- E-VII: Additional Requirements

### Section F. Alternative Operating Scenario(s)

- F-I: Restrictions
- F-II: Testing Requirements



## **SECTION A. Table of Contents**

- F-III: Monitoring Requirements
- F-IV: Recordkeeping Requirements
- F-V: Reporting Requirements
- F-VI: Work Practice Standards
- F-VII: Additional Requirements

## **Section G. Emission Restriction Summary**

## **Section H. Miscellaneous**

**SECTION A. Plan Approval Inventory List**

Source ID	Source Name	Capacity/Throughput	Fuel/Material
031	ETHANE CRACKING FURNACE #1	620.000 MMBTU/HR	
032	ETHANE CRACKING FURNACE #2	620.000 MMBTU/HR	
033	ETHANE CRACKING FURNACE #3	620.000 MMBTU/HR	
034	ETHANE CRACKING FURNACE #4	620.000 MMBTU/HR	
035	ETHANE CRACKING FURNACE #5	620.000 MMBTU/HR	
036	ETHANE CRACKING FURNACE #6	620.000 MMBTU/HR	
037	ETHANE CRACKING FURNACE #7	620.000 MMBTU/HR	
101	COMBUSTION TURBINE/DUCT BURNER UNIT #1	715.400 MMBTU/HR	
102	COMBUSTION TURBINE/DUCT BURNER UNIT #2	715.400 MMBTU/HR	
103	COMBUSTION TURBINE/DUCT BURNER UNIT #3	715.400 MMBTU/HR	
104	COGENERATION PLANT COOLING TOWER		
105	DIESEL-FIRED EMERGENCY GENERATOR ENGINES (2)		
106	FIRE PUMP ENGINES (2)		
201	ETHYLENE MANUFACTURING LINE		
202	POLYETHYLENE MANUFACTURING LINES		
203	PROCESS COOLING TOWER		
204	CVTO HEADER SYSTEM		
205	HIGH PRESSURE (HP) HEADER SYSTEM		
206	SPENT CAUSTIC VENT HEADER SYSTEM		
301	POLYETHYLENE PELLET MATERIAL STORAGE/HANDLING/LOADOUT		
302	LIQUID LOADOUT (RECOVERED OIL)		
303	LIQUID LOADOUT (PYROLYSIS FO, LT GASOLINE, PE3 HEAVIES)		
304	LIQUID LOADOUT (C3+, BUTENE, ISOPENTANE, ISOBUTANE, C3 REF)		
305	LIQUID LOADOUT (BLENDED PITCH)		
401	STORAGE TANKS (RECOVERED OIL, EQUALIZATION WASTEWATER)		
402	STORAGE TANK (SPENT CAUSTIC)		
403	STORAGE TANKS (LIGHT GASOLINE)		
404	STORAGE TANKS (HEXENE)		
405	STORAGE TANKS (MISC PRESSURIZED)		
406	STORAGE TANKS (DIESEL FUEL > 150 GALLONS)		
407	STORAGE TANKS (PYROLYSIS FUEL OIL)		
501	EQUIPMENT COMPONENTS		
502	WASTEWATER TREATMENT PLANT (SECONDARY & TERTIARY TREATMENT)		
503	PLANT ROADWAYS		
C031	SCR (ETHANE CRACKING FURNACE #1)		
C032	SCR (ETHANE CRACKING FURNACE #2)		
C033	SCR (ETHANE CRACKING FURNACE #3)		
C034	SCR (ETHANE CRACKING FURNACE #4)		
C035	SCR (ETHANE CRACKING FURNACE #5)		
C036	SCR (ETHANE CRACKING FURNACE #6)		
C037	SCR (ETHANE CRACKING FURNACE #7)		

**SECTION A. Plan Approval Inventory List**

Source ID	Source Name	Capacity/Throughput	Fuel/Material
C101	SCR (UNIT #1)		
C101A	OXIDATION CATALYST (UNIT #1)		
C102	SCR (UNIT #2)		
C102A	OXIDATION CATALYST (UNIT #2)		
C103	SCR (UNIT #3)		
C103A	OXIDATION CATALYST (UNIT #3)		
C104	DRIFT ELIMINATORS (COGEN COOLING TOWER)		
C202	PARTICULATE FILTERS (PE MFG)		
C203	DRIFT ELIMINATORS (PROCESS COOLING TOWER)		
C204	LP SYSTEM		
C204A	CVTO		
C204B	LP MULTIPOINT GROUND FLARE (MPGF)		
C205	HP FLARE SYSTEM		
C205A	TEGF A		
C205B	TEGF B		
C205C	HP ELEVATED FLARE		
C206	SCTO		
C301	FABRIC FILTERS (PE PELLET STORAGE/HANDLING/LOADOUT)		
C406	CARBON CANISTERS (DIESEL STORAGE TANKS)		
S031	STACK (ETHANE CRACKING FURNACE #1)		
S032	STACK (ETHANE CRACKING FURNACE #2)		
S033	STACK (ETHANE CRACKING FURNACE #3)		
S034	STACK (ETHANE CRACKING FURNACE #4)		
S035	STACK (ETHANE CRACKING FURNACE #5)		
S036	STACK (ETHANE CRACKING FURNACE #6)		
S037	STACK (ETHANE CRACKING FURNACE #7)		
S101	STACK (UNIT #1)		
S102	STACK (UNIT #2)		
S103	STACK (UNIT #3)		
S105	STACKS (DIESEL-FIRED EMERGENCY GENERATOR ENGINES)		
S106	STACKS (FIRE PUMP ENGINES)		
S202	STACKS (PE MFG PARTICULATE FILTERS)		
S204A	STACK (CVTO)		
S204B	FUGITIVE EMISSIONS (LP MPGF)		
S205A	STACK (TEGF A)		
S205B	STACK (TEGF B)		
S205C	STACK (HP ELEVATED FLARE)		
S206	STACK (SCTO)		
S301	STACKS (PE PELLET FABRIC FILTERS)		
S406	STACKS (CARBON CANISTERS)		
Z104	FUGITIVE EMISSIONS (COGEN COOLING TOWER)		
Z203	FUGITIVE EMISSIONS (PROCESS COOLING TOWER)		

**SECTION A. Plan Approval Inventory List**

Source ID	Source Name	Capacity/Throughput	Fuel/Material
Z302	FUGITIVE EMISSIONS (LIQUID LOADOUT)		
Z501	FUGITIVE EMISSIONS (COMPONENT LEAKS)		
Z502	FUGITIVE EMISSIONS (WWTP)		
Z503	FUGITIVE EMISSIONS (PLANT ROADWAYS)		

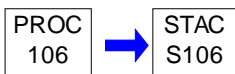
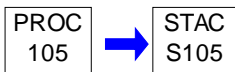
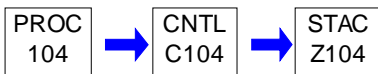
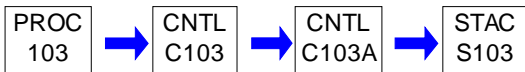
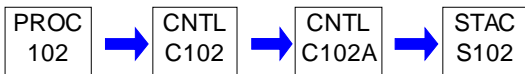
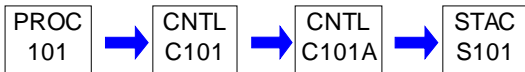
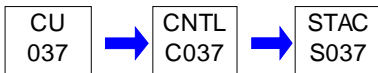
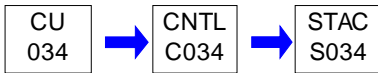
**PERMIT MAPS**



PERMIT MAPS

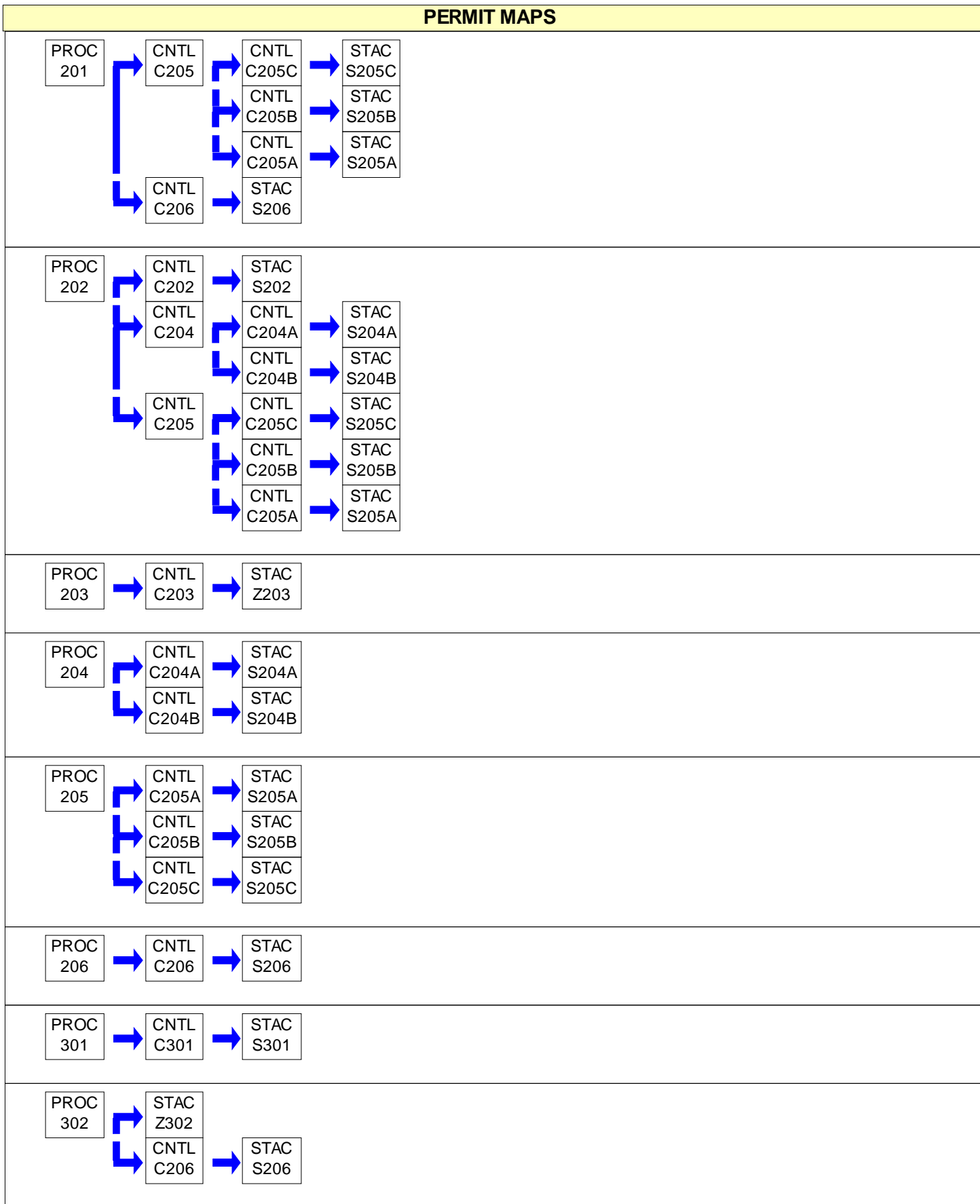



## PERMIT MAPS

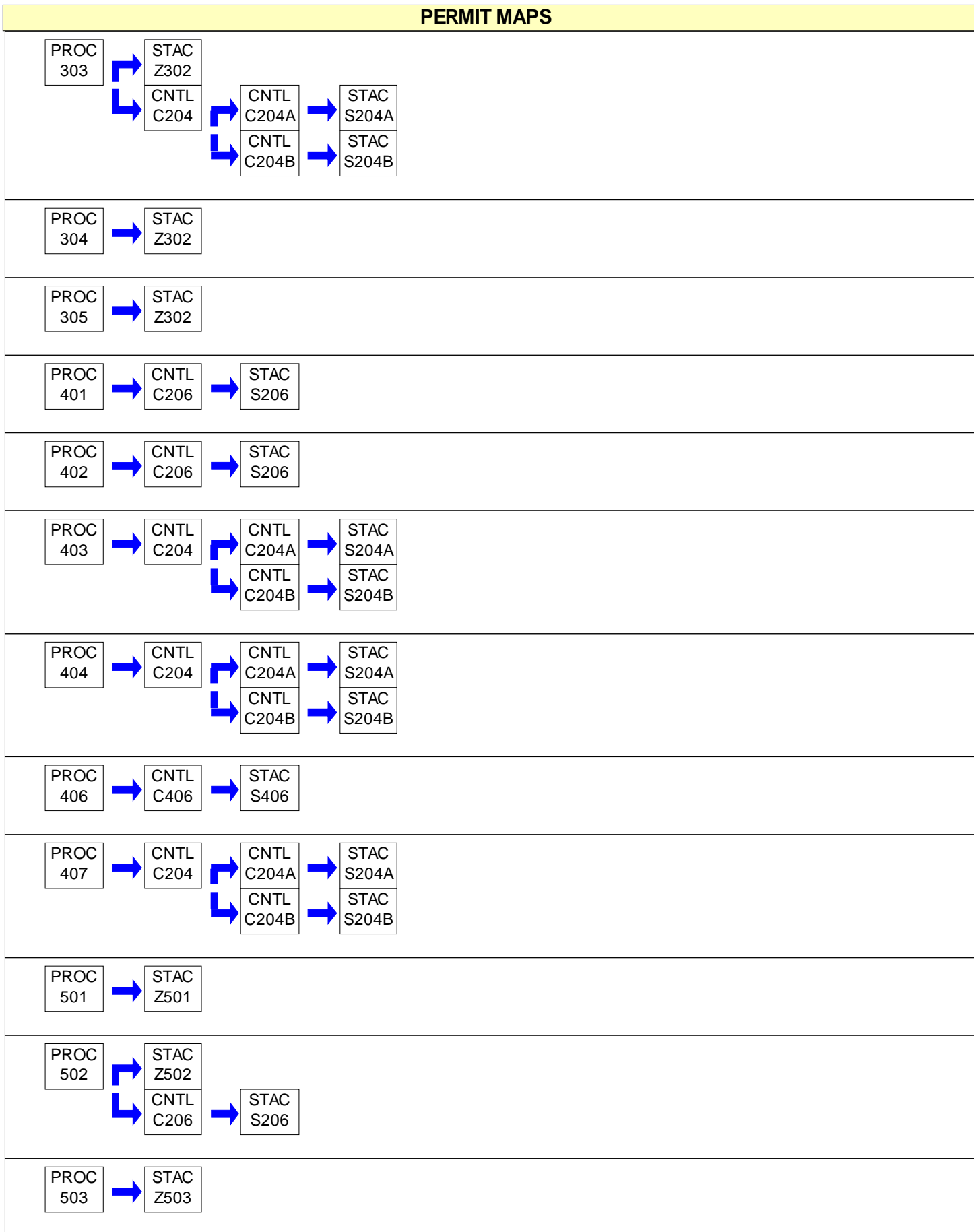

**SECTION B. General Plan Approval Requirements****#001 [25 Pa. Code § 121.1]****Definitions**

Words and terms that are not otherwise defined in this plan approval shall have the meanings set forth in Section 3 of the Air Pollution Control Act (35 P.S. § 4003) and 25 Pa. Code § 121.1.

**#002 [25 Pa. Code § 127.12b (a) (b)]****Future Adoption of Requirements**

The issuance of this plan approval does not prevent the future adoption by the Department of any rules, regulations or standards, or the issuance of orders necessary to comply with the requirements of the Federal Clean Air Act or the Pennsylvania Air Pollution Control Act, or to achieve or maintain ambient air quality standards. The issuance of this plan approval shall not be construed to limit the Department's enforcement authority.

**#003 [25 Pa. Code § 127.12b]****Plan Approval Temporary Operation**

This plan approval authorizes temporary operation of the source(s) covered by this plan approval provided the following conditions are met.

(a) When construction, installation, modification, or reactivation is being conducted, the permittee shall provide written notice to the Department of the completion of the activity approved by this plan approval and the permittee's intent to commence operation at least five (5) working days prior to the completion of said activity. The notice shall state when the activity will be completed and when the permittee expects to commence operation. When the activity involves multiple sources on different time schedules, notice is required for the commencement of operation of each source.

(b) Pursuant to 25 Pa. Code § 127.12b (d), temporary operation of the source(s) is authorized to facilitate the shakedown of sources and air cleaning devices, to permit operations pending the issuance of a permit under 25 Pa. Code Chapter 127, Subchapter F (relating to operating permits) or Subchapter G (relating to Title V operating permits) or to permit the evaluation of the air contaminant aspects of the source.

(c) This plan approval authorizes a temporary operation period not to exceed 180 days from the date of commencement of operation, provided the Department receives notice from the permittee pursuant to paragraph (a), above.

(d) The permittee may request an extension of the 180-day shakedown period if further evaluation of the air contamination aspects of the source(s) is necessary. The request for an extension shall be submitted, in writing, to the Department at least 30 days prior to the end of the initial 180-day shakedown period and shall provide a description of the compliance status of the source, a detailed schedule for establishing compliance, and the reasons compliance has not been established. This temporary operation period will be valid for a limited time and may be extended for additional limited periods, each not to exceed 180 days.

(e) The notice submitted by the permittee pursuant to subpart (a) above, prior to the expiration of the plan approval, shall modify the plan approval expiration date on Page 1 of this plan approval. The new plan approval expiration date shall be 180 days from the date of commencement of operation.

**#004 [25 Pa. Code § 127.12(a) (10)]****Content of Applications**

The permittee shall maintain and operate the sources and associated air cleaning devices in accordance with good engineering practice as described in the plan approval application submitted to the Department.

**#005 [25 Pa. Code §§ 127.12(c) and (d) & 35 P.S. § 4013.2]****Public Records and Confidential Information**

(a) The records, reports or information obtained by the Department or referred to at public hearings shall be available to the public, except as provided in paragraph (b) of this condition.

(b) Upon cause shown by the permittee that the records, reports or information, or a particular portion thereof, but not emission data, to which the Department has access under the act, if made public, would divulge production or sales figures or methods, processes or production unique to that person or would otherwise tend to affect adversely the

**SECTION B. General Plan Approval Requirements**

competitive position of that person by revealing trade secrets, including intellectual property rights, the Department will consider the record, report or information, or particular portion thereof confidential in the administration of the act. The Department will implement this section consistent with sections 112(d) and 114(c) of the Clean Air Act (42 U.S.C.A. § § 7412(d) and 7414(c)). Nothing in this section prevents disclosure of the report, record or information to Federal, State or local representatives as necessary for purposes of administration of Federal, State or local air pollution control laws, or when relevant in a proceeding under the act.

**#006 [25 Pa. Code § 127.12b]****Plan Approval Terms and Conditions**

[Additional authority for this condition is derived from 25 Pa. Code Section 127.13]

(a) This plan approval will be valid for a limited time, as specified by the expiration date contained on Page 1 of this plan approval. Except as provided in § § 127.11a and 127.215 (relating to reactivation of sources; and reactivation), at the end of the time, if the construction, modification, reactivation or installation has not been completed, a new plan approval application or an extension of the previous approval will be required.

(b) If construction has commenced, but cannot be completed before the expiration of this plan approval, an extension of the plan approval must be obtained to continue construction. To allow adequate time for departmental action, a request for the extension shall be postmarked at least thirty (30) days prior to the expiration date. The request for an extension shall include the following:

- (i) A justification for the extension,
- (ii) A schedule for the completion of the construction

If construction has not commenced before the expiration of this plan approval, then a new plan approval application must be submitted and approval obtained before construction can commence.

(c) If the construction, modification or installation is not commenced within 18 months of the issuance of this plan approval or if there is more than an 18-month lapse in construction, modification or installation, a new plan approval application that meets the requirements of 25 Pa. Code Chapter 127, Subchapter B (related to plan approval requirements), Subchapter D (related to prevention of significant deterioration of air quality), and Subchapter E (related to new source review) shall be submitted. The Department may extend the 18-month period upon a satisfactory showing that an extension is justified.

**#007 [25 Pa. Code § 127.32]****Transfer of Plan Approvals**

(a) This plan approval may not be transferred from one person to another except when a change of ownership is demonstrated to the satisfaction of the Department and the Department approves the transfer of the plan approval in writing.

(b) Section 127.12a (relating to compliance review) applies to a request for transfer of a plan approval. A compliance review form shall accompany the request.

(c) This plan approval is valid only for the specific source and the specific location of the source as described in the application.

**#008 [25 Pa. Code § 127.12(a)(4) & 35 P.S. § 4008 & § 114 of the CAA]****Inspection and Entry**

(a) Pursuant to 35 P.S. § 4008, no person shall hinder, obstruct, prevent or interfere with the Department or its personnel in the performance of any duty authorized under the Air Pollution Control Act.

(b) The permittee shall also allow the Department to have access at reasonable times to said sources and associated air cleaning devices with such measuring and recording equipment, including equipment recording visual observations, as the Department deems necessary and proper for performing its duties and for the effective enforcement of the Air Pollution Control Act and regulations adopted under the act.

**SECTION B. General Plan Approval Requirements**

(c) Nothing in this plan approval condition shall limit the ability of the Environmental Protection Agency to inspect or enter the premises of the permittee in accordance with Section 114 or other applicable provisions of the Clean Air Act.

**#009 [25 Pa. Code 127.13a]****Plan Approval Changes for Cause**

This plan approval may be terminated, modified, suspended or revoked and reissued if one or more of the following applies:

- (a) The permittee constructs or operates the source subject to the plan approval in violation of the act, the Clean Air Act, the regulations promulgated under the act or the Clean Air Act, a plan approval or permit or in a manner that causes air pollution.
- (b) The permittee fails to properly or adequately maintain or repair an air pollution control device or equipment attached to or otherwise made a part of the source.
- (c) The permittee fails to submit a report required by this plan approval.
- (d) The Environmental Protection Agency determines that this plan approval is not in compliance with the Clean Air Act or the regulations thereunder.

**#010 [25 Pa. Code §§ 121.9 & 127.216]****Circumvention**

- (a) The permittee, or any other person, may not circumvent the new source review requirements of 25 Pa. Code Chapter 127, Subchapter E by causing or allowing a pattern of ownership or development, including the phasing, staging, delaying or engaging in incremental construction, over a geographic area of a facility which, except for the pattern of ownership or development, would otherwise require a permit or submission of a plan approval application.
- (b) No person may permit the use of a device, stack height which exceeds good engineering practice stack height, dispersion technique or other technique which, without resulting in reduction of the total amount of air contaminants emitted, conceals or dilutes an emission of air contaminants which would otherwise be in violation of this plan approval, the Air Pollution Control Act or the regulations promulgated thereunder, except that with prior approval of the Department, the device or technique may be used for control of malodors.

**#011 [25 Pa. Code § 127.12c]****Submissions**

Reports, test data, monitoring data, notifications shall be submitted to the:

Regional Air Program Manager  
PA Department of Environmental Protection  
(At the address given on the plan approval transmittal letter or otherwise notified)

**#012 [25 Pa. Code § 127.12(a)(9) & 40 CFR Part 68]****Risk Management**

(a) If required by Section 112(r) of the Clean Air Act, the permittee shall develop and implement an accidental release program consistent with requirements of the Clean Air Act, 40 CFR Part 68 (relating to chemical accident prevention provisions) and the Federal Chemical Safety Information, Site Security and Fuels Regulatory Relief Act (P.L. 106-40).

(b) The permittee shall prepare and implement a Risk Management Plan (RMP) which meets the requirements of Section 112(r) of the Clean Air Act, 40 CFR Part 68 and the Federal Chemical Safety Information, Site Security and Fuels Regulatory Relief Act when a regulated substance listed in 40 CFR § 68.130 is present in a process in more than the listed threshold quantity at the facility. The permittee shall submit the RMP to the Environmental Protection Agency according to the following schedule and requirements:

(1) The permittee shall submit the first RMP to a central point specified by the Environmental Protection Agency no later than the latest of the following:

**SECTION B. General Plan Approval Requirements**

- (i) Three years after the date on which a regulated substance is first listed under § 68.130; or,
- (ii) The date on which a regulated substance is first present above a threshold quantity in a process.

(2) The permittee shall submit any additional relevant information requested by the Department or the Environmental Protection Agency concerning the RMP and shall make subsequent submissions of RMPs in accordance with 40 CFR § 68.190.

(3) The permittee shall certify that the RMP is accurate and complete in accordance with the requirements of 40 CFR Part 68, including a checklist addressing the required elements of a complete RMP.

(c) As used in this plan approval condition, the term "process" shall be as defined in 40 CFR § 68.3. The term "process" means any activity involving a regulated substance including any use, storage, manufacturing, handling, or on-site movement of such substances or any combination of these activities. For purposes of this definition, any group of vessels that are interconnected, or separate vessels that are located such that a regulated substance could be involved in a potential release, shall be considered a single process.

**#013 [25 Pa. Code § 121.7]****Prohibition of Air Pollution**

No person may permit air pollution as that term is defined in the Air Pollution Control Act (35 P.S. §§ 4001-4015).

**#014 [25 Pa. Code § 127.25]****Compliance Requirement**

A person may not cause or permit the operation of a source subject to § 127.11 (relating to plan approval requirements), unless the source and air cleaning devices identified in the application for the plan approval and the plan approval issued to the source, are operated and maintained in accordance with specifications in the application and conditions in the plan approval issued by the Department. A person may not cause or permit the operation of an air contamination source subject to this chapter in a manner inconsistent with good operating practices.

**SECTION C. Site Level Plan Approval Requirements****I. RESTRICTIONS.****Emission Restriction(s).****# 001 [25 Pa. Code §121.7]****Prohibition of air pollution.**

No person may permit air pollution as that term is defined in the act.

**# 002 [25 Pa. Code §123.1]****Prohibition of certain fugitive emissions**

(a) No person may permit the emission into the outdoor atmosphere of fugitive air contaminant from a source other than the following:

(1) Construction or demolition of buildings or structures.

(2) Grading, paving and maintenance of roads and streets.

(3) Use of roads and streets. Emissions from material in or on trucks, railroad cars and other vehicular equipment are not considered as emissions from use of roads and streets.

(4) Clearing of land.

(5) Stockpiling of materials.

(6) Open burning operations.

(7) Blasting in open pit mines. Emissions from drilling are not considered as emissions from blasting.

(8) Coke oven batteries, provided the fugitive air contaminants emitted from any coke oven battery comply with the standards for visible fugitive emissions in § § 123.44 and 129.15 (relating to limitations of visible fugitive air contaminants from operation of any coke oven battery; and coke pushing operations).

(9) Sources and classes of sources other than those identified in paragraphs (1)-(8), for which the operator has obtained a determination from the Department that fugitive emissions from the source, after appropriate control, meet the following requirements:

(i) the emissions are of minor significance with respect to causing air pollution; and

(ii) the emissions are not preventing or interfering with the attainment or maintenance of any ambient air quality standard.

(b) An application form for requesting a determination under either subsection (a)(9) or 129.15(c) is available from the Department. In reviewing these applications, the Department may require the applicant to supply information including, but not limited to, a description of proposed control measures, characteristics of emissions, quantity of emissions, and ambient air quality data and analysis showing the impact of the source on ambient air quality. The applicant shall be required to demonstrate that the requirements of subsections (a)(9) and (c) and 123.2 (relating to fugitive particulate matter) or of the requirements of 129.15(c) have been satisfied. Upon such demonstration, the Department will issue a determination, in writing, either as an operating permit condition, for those sources subject to permit requirements under the act, or as an order containing appropriate conditions and limitations.

(c) A person responsible for any source specified in subsections (a)(1) -- (7) or (9) shall take all reasonable actions to prevent particulate matter from becoming airborne. These actions shall include, but not be limited to, the following:

(1) Use, where possible, of water or chemicals for control of dust in the demolition of buildings or structures, construction operations, the grading of roads, or the clearing of land.

(2) Application of asphalt, oil, water or suitable chemicals on dirt roads, material stockpiles and other surfaces which may give rise to airborne dusts.

**SECTION C. Site Level Plan Approval Requirements**

(3) Paving and maintenance of roadways.

(4) Prompt removal of earth or other material from paved streets onto which earth or other material has been transported by trucking or earth moving equipment, erosion by water, or other means.

(d) N/A

**# 003 [25 Pa. Code §123.2]****Fugitive particulate matter**

A person may not permit fugitive particulate matter to be emitted into the outdoor atmosphere from a source specified in 123.1(a)(1) -- (9) (relating to prohibition of certain fugitive emissions) if such emissions are visible at the point the emissions pass outside the person's property.

**# 004 [25 Pa. Code §123.31]****Limitations**

The Owner/Operator may not permit the emission into the outdoor atmosphere of any malodorous air contaminants from any source in such a manner that the malodors are detectable outside of the Owner/Operator's property.

**# 005 [25 Pa. Code §127.12b]****Plan approval terms and conditions.**

Emissions from the Facility shall not equal or exceed the following in any consecutive 12-month period:

Air Contaminant	Emission Rate (tons)
NOx	348
CO	1,012
PM (filterable)	71
PM10	164
PM2.5	159
SOx	21
VOC	522
VOC (ERC)*	620
HAP	30.5
Ammonia	152
CO2e	2,248,293

\* This limit is included to ensure that the proper amount of VOC ERCs are secured by the applicant in accordance with the VOC offset ratios for flue and fugitive emissions under 25 Pa. Code §127.210. Compliance with this limit will be determined by actual VOC emissions at the Facility and the following equation:

$$\text{VOC (ERC)} = 1.15 * \text{sum}(\text{flue VOC emissions}) + 1.3 * \text{sum}(\text{fugitive VOC emissions}) \quad (\text{Eq. 1})$$

Where:

Flue VOC emissions are actual emissions from the ethane cracking furnaces, combustion turbines/duct burners, incinerators, flares, engines, miscellaneous storage tanks, and polyethylene pellet residual VOC.

Fugitive VOC emissions are actual emissions from liquid loadout, component leaks, the process cooling tower, and wastewater treatment plant.

**# 006 [25 Pa. Code §127.12b]****Plan approval terms and conditions.**

Total benzene quantity from facility waste shall not equal or exceed 11 tons per year as determined through 40 CFR §61.355. [This limit is for the purpose of compliance with limited requirements of 40 CFR Part 61 Subpart FF for a facility with benzene waste less than 10 Mg (11 tons) per year].

**SECTION C. Site Level Plan Approval Requirements****# 007 [25 Pa. Code §129.14]****Open burning operations**

Open burning operations:

- a. Air basins. No person may permit the open burning of material in an air basin.
- b. Outside of air basins. N/A
- c. Exceptions. The requirements of subsections a) and b) do not apply where the open burning operations result from:
  - 1) A fire set to prevent or abate a fire hazard, when approved by the Department and set by or under the supervision of a public officer.
  - 2) Any fire set for the purpose of instructing personnel in fire fighting, when approved by the Department.
  - 3) A fire set for the prevention and control of disease or pests, when approved by the Department.
  - 4) A fire set in conjunction with the production of agricultural commodities in their unmanufactured state on the premises of the farm operation.
  - 5) A fire set for the purpose of burning domestic refuse, when the fire is on the premises of a structure occupied solely as a dwelling by two families or less and when the refuse results from the normal occupancy of the structure.
  - 6) A fire set solely for recreational or ceremonial purposes.
  - 7) A fire set solely for cooking food.
- d. Clearing and grubbing wastes. The following is applicable to clearing and grubbing wastes:
  - 1) As used in this subsection the following terms shall have the following meanings:  
 Air curtain destructor - A mechanical device which forcefully projects a curtain of air across a pit in which open burning is being conducted so that combustion efficiency is increased and smoke and other particulate matter are contained.  
 Clearing and grubbing wastes - Trees, shrubs and other native vegetation which are cleared from land during or prior to the process of construction. The term does not include demolition wastes and dirt laden roots.
  - 2) Subsection (a) notwithstanding, clearing and grubbing wastes may be burned in a basin subject to the following requirements:
    - i. Air curtain destructors shall be used when burning clearing and grubbing wastes.
    - ii. Each proposed use of air curtain destructors shall be reviewed and approved by the Department in writing with respect to equipment arrangement, design and existing environmental conditions prior to commencement of burning. Proposals approved under this subparagraph need not obtain plan approval or operating permits under Chapter 127 (relating to construction, modification, reactivation and operation of sources).
    - iii. Approval for use of an air curtain destructor at one site may be granted for a specified period not to exceed 3 months, but may be extended for additional limited periods upon further approval by the Department.
    - iv. The Department reserves the right to rescind approval granted if a determination by the Department indicates that an air pollution problem exists.
  - 3) N/A
  - 4) During an air pollution episode, open burning is limited by Chapter 137 (relating to air pollution episodes) and shall cease as specified in that chapter.

**Fuel Restriction(s).****# 008 [25 Pa. Code §127.12b]****Plan approval terms and conditions.**

Sulfur content of the gaseous fuels combusted at this facility shall not exceed 0.5 grains per 100 dscf.

**II. TESTING REQUIREMENTS.****# 009 [25 Pa. Code §127.12b]****Plan approval terms and conditions.**

Performance testing shall be conducted as follows:

**SECTION C. Site Level Plan Approval Requirements**

- a. The Owner/Operator shall submit three copies of a pre-test protocol to the Department for review at least 45 days prior to the performance of any EPA Reference Method stack test. The Owner/Operator shall submit three copies of a one-time protocol to the Department for review for the use of a portable analyzer and may repeat portable analyzer testing without additional protocol approvals provided that the same method and equipment are used. All proposed performance test methods shall be identified in the pre-test protocol and approved by the Department prior to testing.
- b. The Owner/Operator shall notify the Regional Air Quality Manager at least 15 days prior to any performance test so that an observer may be present at the time of the test. This notification may be sent by email. Notification shall also be sent to the Division of Source Testing and Monitoring. Performance testing shall not be conducted except in accordance with an approved protocol.
- c. Pursuant to 40 CFR Part 60.8(a) and 40 CFR Part 63.9(h), a complete test report shall be submitted to the Department no later than 60 calendar days after completion of the on-site testing portion of an emission test program.
- d. Pursuant to 40 CFR Part 61.13(f), a complete test report shall be submitted to the Department no later than 31 calendar days after completion of the on-site testing portion of an emission test program.
- e. Pursuant to 25 Pa. Code Section 139.53(b) a complete test report shall include a summary of the emission results on the first page of the report indicating if each pollutant measured is within permitted limits and a statement of compliance or non-compliance with all applicable permit conditions. The summary results will include, at a minimum, the following information:
1. A statement that the owner or operator has reviewed the report from the emissions testing body and agrees with the findings.
  2. Permit number(s) and condition(s) which are the basis for the evaluation.
  3. Summary of results with respect to each applicable permit condition.
  4. Statement of compliance or non-compliance with each applicable permit condition.
- f. Pursuant to 25 Pa. Code § 139.3 all submittals shall meet all applicable requirements specified in the most current version of the Department's Source Testing Manual.
- g. All testing shall be performed in accordance with the provisions of Chapter 139 of the Rules and Regulations of the Department of Environmental Protection.
- h. Pursuant to 25 Pa. Code Section 139.53(a)(1) and 139.53(a)(3) all submittals, besides notifications, shall be accomplished through PSIMS\*Online available through <https://www.depgreenport.state.pa.us/ecomm/Login.jsp> when it becomes available. If internet submittal can not be accomplished, three copies of the submittal shall be sent to the Pennsylvania Department of Environmental Protection, Bureau of Air Quality, Division of Source Testing and Monitoring, 400 Market Street, 12th Floor Rachael Carson State Office Building, Harrisburg, PA 17105-8468 with deadlines verified through document postmarks.
- i. The permittee shall ensure all federal reporting requirements contained in the applicable subpart of 40 CFR are followed, including timelines more stringent than those contained herein. In the event of an inconsistency or any conflicting requirements between state and the federal, the most stringent provision, term, condition, method or rule shall be used by default.

**# 010 [40 CFR Part 61 NESHAPs §40 CFR 61.355]****Subpart FF--National Emission Standard for Benzene Waste Operations  
Test methods, procedures, and compliance provisions.**

The Owner/Operator shall determine total annual benzene quantity from facility waste as specified in 40 CFR §61.355(a) through (c).

**III. MONITORING REQUIREMENTS.****# 011 [25 Pa. Code §127.12b]****Plan approval terms and conditions.**

Employees involved in the operation and/or maintenance of any air contamination sources, air cleaning devices, stacks,

**SECTION C. Site Level Plan Approval Requirements**

fugitive emission areas, or process equipment at the Facility shall conduct observations of all air contamination sources, air cleaning devices, stacks, fugitive emission areas, and process equipment at a minimum of once per shift while the Facility is in operation. These observations are to ensure continued compliance with source-specific visible emission limitations, fugitive emissions prohibited under 25 Pa. Code §§123.1 or 123.2, and malodors prohibited under 25 Pa. Code §123.31. Observations shall be conducted for the presence of the following:

- a. Visible stack emissions;
- b. Fugitive emissions; and
- c. Potentially objectionable odors.

If visible stack emissions, fugitive emissions, or potentially objectionable odors are apparent; the Owner/Operator shall take corrective action. Each observation of a visible stack emission, fugitive emission, or potentially objectionable odor shall be reported to a centralized incident coordinator and recorded. Records of each reported observation shall be maintained in a log and at the minimum include the date, time, name and title of the observer, along with any corrective action taken as a result.

**# 012 [40 CFR Part 61 NESHAPs §40 CFR 61.354]****Subpart FF--National Emission Standard for Benzene Waste Operations  
Monitoring of operations.**

The Owner/Operator shall comply with the applicable monitoring requirements for benzene waste operations specified in 40 CFR §61.354.

**IV. RECORDKEEPING REQUIREMENTS.****# 013 [25 Pa. Code §127.12b]****Plan approval terms and conditions.**

All logs and required records shall be maintained on site, or at an alternative location acceptable to the Department, for a minimum of five years and shall be made available to the Department upon request.

**# 014 [25 Pa. Code §127.12b]****Plan approval terms and conditions.**

The Owner/Operator shall maintain the following comprehensive and accurate records:

- a. Monthly rolling 12-month totals of the hours of operation in each defined operating mode for each ethane cracking furnace and each combustion turbine.
- b. Calendar year totals for each diesel-fired emergency generator and fire pump engine of (and as defined in 40 CFR Part 60 Subpart IIII):
  - 1) Hours of emergency operation,
  - 2) Hours of maintenance and/or testing operation,
  - 3) Hours of non-emergency operation that is not maintenance and/or testing, and
  - 4) Hours of operation.
- c. Monthly rolling 12-month totals (in MMscf) of tail gas and natural gas consumed by each ethane cracking furnace, combustion turbine, and duct burner.
- d. Monthly rolling 12-month totals (in MMscf) of gas combusted by the LP incinerator, MPGF, HP ground flares, emergency elevated flare, and Spent Caustic Vent incinerator.
- e. Monthly rolling 12-month totals (in metric tons) of produced ethylene and polyethylene.
- f. Monthly rolling 12-month totals (in gallons) of C3+, coke residue/tar, recovered oil, pyrolysis fuel oil, and light gasoline loaded out from the Facility.
- g. Monthly rolling 12-month totals of calculated actual VOC and VOC (ERC) emissions in accordance with Equation 1 specified in this Plan Approval.
- h. Monthly rolling 12-month averages of calculated TDS from each cooling tower.
- i. Records including a description of testing methods, results, all operating data collected during tests, and a copy of the calculations performed to determine compliance with emission standards for the ethane cracking furnaces, combustion turbines, and incinerators.
- j. Copies of manufacturer's or EPC contractor's equipment design specifications necessary to determine compliance with required control efficiencies or outlet emission rates.
- k. Copies of maintenance procedures and schedules for all air contamination sources and air cleaning devices authorized

**SECTION C. Site Level Plan Approval Requirements**

under this plan approval.

l. Records of any maintenance conducted on the air contamination sources and air cleaning devices authorized under this plan approval.

m. Records that diesel fuel's total sulfur content does not exceed 15 ppm, and that either cetane index is a minimum of 40 or aromatic content does not exceed 35 % by volume.

n. Records that each gaseous fuel's total sulfur content does not exceed 0.5 grains per 100 dscf. This may be demonstrated by a current, valid purchase contract, tariff sheet or transportation contract for the fuel; or fuel total sulfur content monitoring in accordance with 40 CFR §§60.4360 and 60.4370, applicable to the turbines.

o. Records of observations of visible stack emissions, fugitive emissions, and potentially objectionable odors including the date, time, name, and title of the observer, along with any corrective action taken as a result.

**# 015 [40 CFR Part 61 NESHAPs §40 CFR 61.356]****Subpart FF--National Emission Standard for Benzene Waste Operations Recordkeeping requirements.**

The Owner/Operator shall comply with the applicable recordkeeping requirements for benzene waste operations specified in 40 CFR §61.356.

**V. REPORTING REQUIREMENTS.****# 016 [25 Pa. Code §127.12b]****Plan approval terms and conditions.**

The Owner/Operator shall provide the Department with a statement; in a form as the Department may prescribe; for classes or categories of sources; showing the actual emissions of NO<sub>x</sub>, CO, VOC, SO<sub>x</sub>, PM<sub>10</sub>, PM<sub>2.5</sub>, HAP (per the Department's Emissions Inventory Reporting Instructions), NH<sub>3</sub>, and GHG (including but not limited to CO<sub>2</sub>, CH<sub>4</sub>, and N<sub>2</sub>O) for each reporting period. A description of the method used to calculate the emissions and the time period over which the calculation is based shall be included. The statement shall also contain a certification by a company officer or the plant manager that the information contained in the statement is accurate.

**# 017 [25 Pa. Code §127.12b]****Plan approval terms and conditions.**

The Owner/Operator shall provide EPA with the notifications required by 40 CFR 40 CFR Part 60 Subpart A, 40 CFR Part 61 Subpart A, and 40 CFR Part 63 Subpart A.

**# 018 [25 Pa. Code §127.12b]****Plan approval terms and conditions.**

Malfunction notification, reporting, and responses shall be conducted as follows:

a. For purpose of this condition a malfunction is defined as any sudden, infrequent, and not reasonably preventable failure of air pollution control or monitoring equipment, or the unauthorized operation of a source that may result in an increase in the emission of air contaminants above allowable levels. Examples of malfunctions may include, but are not limited to: large dust plumes, heavy smoke, a spill or release that results in a malodor that is detectable outside the property of the person on whose land the source is being operated.

b. Notify the Department by phone no later than one hour after discovery of a malfunction which poses an imminent and substantial danger to the public health and safety or the environment. The notification shall include the items identified in (d) to the extent known.

c. Notify the Department by phone no later than the next business day after discovery of all other malfunctions. The notification shall include the items identified in (d) to the extent known.

d. The notification shall describe the:

- i. Name and location of the facility;
- ii. Nature and cause of the malfunction or breakdown;
- iii. Time when the malfunction or breakdown was first observed;
- iv. Expected duration of excess emissions; and
- v. Estimated rate of emissions.

**SECTION C. Site Level Plan Approval Requirements**

- e. The Owner/Operator shall submit a written report to the Department no later than thirty (30) days following the end of a malfunction. The report shall include the following:
- i. The date and time that the malfunction started and ended.
  - ii. An estimate of the emissions associated with the malfunction and the calculations that were used to determine that quantity;
  - iii. The steps, if any, that the facility took to limit the duration and/or quantity of emissions associated with the malfunction;
  - iv. A detailed analysis that sets forth the Root Cause of the malfunction, to the extent determinable;
  - v. An analysis of the measures, if any, that are available to reduce the likelihood of a recurrence of a malfunction resulting from the same Root Cause or contributing causes in the future. The analysis shall discuss the alternatives, if any, that are available, the probable effectiveness and cost of the alternatives. Possible design, operational, and maintenance changes shall be evaluated. If the facility concludes that corrective action(s) is (are) required, the report shall include a description of the action(s) and, if not already completed, a schedule for implementation, including proposed commencement and completion dates. If the facility concludes that corrective action is not required the report shall explain the basis for that conclusion;
  - vi. To the extent that investigations of the causes and/or possible corrective action(s) still are underway on the due date of the report, a statement of the anticipated date by which a follow-up report will be submitted.
- f. To the extent that completion of the implementation of corrective action(s), if any, is not finalized at the time of the submission of the report under subsection (e), then, by no later than 30 days after completion of the implementation of corrective action(s), the Owner/Operator shall submit a written report identifying the corrective action(s) taken and the date(s) of completion of implementation.
- g. In response to any malfunction, the Owner/Operator, as expeditiously as practicable, shall take such interim and/or longer-term corrective actions, if any, as are consistent with good engineering practice to minimize the likelihood of a recurrence of the Root Cause and all contributing causes of that malfunction.
- h. Malfunction phone notifications and written reports shall be submitted to the Department at the following address:

PA DEP  
Office of Air Quality  
400 Waterfront Drive  
Pittsburgh, PA 15222-4745  
412-442-4000

**# 019 [25 Pa. Code §135.3]****Reporting**

Annual emission reporting shall be conducted as follows:

- a. The Owner/Operator shall submit by March 1 of each year, a source report for the preceding calendar year. The report shall include information for all previously reported sources, new sources which were first operated during the preceding calendar year, and sources modified during the same period which were not previously reported.
- b. A person who received initial notification by the Department that a source report is necessary shall submit an initial source report within 60 days after receiving the notification or by March 1 of the year following the year for which the report is required, whichever is later.
- c. A source Owner/Operator may request an extension of time from the Department for the filing of a source report, and the Department may grant the extension for reasonable cause.

**# 020 [40 CFR Part 60 Standards of Performance for New Stationary Sources §40 CFR 60.4]****Subpart A - General Provisions****Address.**

The Facility is subject to New Source Performance Standards from 40 CFR Part 60 Subparts Kb, VV, VVa, DDD, NNN, RRR, IIII, and KKKK. In accordance with 40 CFR §60.4, copies of all requests, reports, applications, submittals and other communications regarding affected sources shall be forwarded to both EPA and the Department at the addresses listed below unless otherwise noted.

**SECTION C. Site Level Plan Approval Requirements**

Director	PADEP
Air Protection Section	Air Quality Program
Mail Code 3AP00	400 Waterfront Drive
U.S. EPA, Region III	Pittsburgh, PA 15222-4745
1650 Arch Street	
Philadelphia, PA 19103-2029	

**# 021 [40 CFR Part 61 NESHAPs §40 CFR 61.04]****Subpart A--General Provisions****Address.**

The Facility is subject to National Emission Standards for Hazardous Air Pollutants from 40 CFR Part 61 Subparts J, V, and FF. In accordance with 40 CFR §61.04, copies of all requests, reports, applications, submittals and other communications regarding affected sources shall be forwarded to both EPA and the Department at the addresses listed below unless otherwise noted.

Director	PADEP
Air Protection Section	Air Quality Program
Mail Code 3AP00	400 Waterfront Drive
U.S. EPA, Region III	Pittsburgh, PA 15222-4745
1650 Arch Street	
Philadelphia, PA 19103-2029	

**# 022 [40 CFR Part 61 NESHAPs §40 CFR 61.357]****Subpart FF--National Emission Standard for Benzene Waste Operations****Reporting requirements.**

The Owner/Operator shall comply with the applicable reporting requirements for benzene waste operations specified in 40 CFR §61.357.

**# 023 [40 CFR Part 63 NESHAPs for Source Categories §40 CFR 63.13]****Subpart A--General Provisions****Addresses of State air pollution control agencies and EPA Regional Offices.**

The Facility is subject to National Emission Standards for Hazardous Air Pollutants from 40 CFR Part 63 Subparts SS, UU, XX, YY, FFFF, YYYY, and ZZZZ. In accordance with 40 CFR §63.13, copies of all requests, reports, applications, submittals and other communications regarding affected sources shall be forwarded to both EPA and the Department at the addresses listed below unless otherwise noted.

Director	PADEP
Air Protection Section	Air Quality Program
Mail Code 3AP00	400 Waterfront Drive
U.S. EPA, Region III	Pittsburgh, PA 15222-4745
1650 Arch Street	
Philadelphia, PA 19103-2029	

**VI. WORK PRACTICE REQUIREMENTS.****# 024 [25 Pa. Code §127.12b]****Plan approval terms and conditions.**

The Owner/Operator shall develop and implement a leak detection and repair (LDAR) program for this facility. All aspects of the LDAR program shall be consistent with 40 CFR Part 63 Subpart UU – National Emission Standards for Equipment Leaks – Control Level 2 Standards, except as follows:

- a. LDAR shall be applied to equipment in organic compound service (including fuel gas equipment).
- b. Organic compound service means that piece of equipment either contains or contacts a fluid (liquid or gas) that is at least 5 wt% of organic compounds as determined according to the provisions of 40 CFR §63.180(d) of Subpart H [except that “organic compound” replaces instances of “organic HAP”]. The provisions of 40 CFR §63.180(d) of Subpart H also specify how to determine that a piece of equipment is not in organic compound service.

**SECTION C. Site Level Plan Approval Requirements**

c. Leak detection shall be conducted on a monthly basis for non-bellows seal valves unless 98.0% or greater of the non-bellows seal gas/vapor and/or light liquid valves are found to leak at a rate less than 100 ppmv for two consecutive months, then the detection frequency may be changed to a quarterly basis. The annual monitoring frequency for valves (skip periods) is not applicable.

d. Equipment is also defined to include screwed connections, heat exchanger heads, sight glasses, meters, gauges, sampling connections, bolted manways, and hatches.

e. Leak detection thresholds for organic compounds shall be as follows:

- i. 100 ppmv from pump seals, compressor seals, flanges, and valves in gas/vapor and light liquid service;
- ii. 200 ppmv from atmospheric pressure relief devices without a rupture disk; and
- iii. 500 ppmv for all other equipment.

f. A first attempt at repair shall be required for all leaking components within 5 days of detection and repair shall be completed within 15 days for all components unless the repair would require a unit shutdown that would create more emissions than the repair would eliminate, and if so, the repair may be delayed until the next scheduled shutdown, except the first attempt at repair for:

- i. Any leak > 10,000 ppmv & < 25,000 ppmv – 2 days;
- ii. Atmospheric pressure relief device leak without a rupture disk > 200 & < 25,000 ppmv – 2 days;
- iii. Any leak > 25,000 ppmv – 1 day;
- iv. Heavy liquid components > 500 ppmv – 1 day; and
- v. Any leak in HRVOC service > 10,000 ppmv – 1 day.

g. Compressors equipped with a closed vent system that captures and transports leakages to the HP System shall meet the LAER requirements for the HP System.

**# 025 [25 Pa. Code §127.12b]****Plan approval terms and conditions.**

Equipment with inherently leakless design features will be installed as practicable.

**# 026 [25 Pa. Code §127.12b]****Plan approval terms and conditions.**

All sampling systems in organic compound service shall be closed-purge, closed loop, or closed-vent systems. In-situ sampling systems shall be exempt.

**# 027 [25 Pa. Code §127.12b]****Plan approval terms and conditions.**

A second valve, blind flange, plug, cap or other equivalent sealing system shall be installed on open ended lines subject to LDAR, except for safety pressure relief valves.

**# 028 [25 Pa. Code §127.12b]****Plan approval terms and conditions.**

All air contamination sources and air cleaning devices authorized under this Plan Approval shall be operated and maintained in accordance with the specifications and maintenance schedule recommended by the manufacturer, developed and approved by the engineering procurement and construction contractor, or developed by the Owner/Operator in accordance with industry standards. Developed maintenance plans shall be in place and available within 180 days of startup of each air contamination source or air cleaning device.

**# 029 [25 Pa. Code §127.12b]****Plan approval terms and conditions.**

Employees involved in the operation and/or maintenance of any air contamination sources, air cleaning devices, stacks, fugitive emission areas, or process equipment at the Facility shall be trained to observe air contamination sources, air cleaning devices, stacks, fugitive emission areas, and process equipment to demonstrate compliance with Section C Condition #012.

**SECTION C. Site Level Plan Approval Requirements**

- a. New employees shall be trained upon hiring.
- b. Existing employees shall be trained prior to source startup.
- c. Employees shall be given refresher training annually.
- d. A copy of the written employee training program shall be maintained at the Facility. The training program shall include provisions for the following:
  - 1) Equipment and areas to be observed;
  - 2) That observation is to be made for the presence of visible stack emissions, fugitive emissions, and potentially objectionable odors;
  - 3) Information to be collected in the event of an affirmative observation; and
  - 4) Whom at the Facility to report affirmative observations to.
- e. Records of successful completion of initial and annual training shall be maintained for a minimum of five years for each employee trained.

**VII. ADDITIONAL REQUIREMENTS.****# 030 [25 Pa. Code §127.12b]****Plan approval terms and conditions.**

Air contamination sources and air cleaning devices authorized to be installed at the Facility under this Plan Approval are as follows:

- Seven (7) tail gas- and natural gas-fired ethane cracking furnaces, 620 MMBtu/hr heat input rating each; equipped with low-NOx burners and controlled by selective catalytic reduction (SCR).
- One (1) ethylene manufacturing line, 1,500,000 metric tons/yr; compressor seal vents and startup/shutdown/maintenance/upsets controlled by the high pressure header system (HP System).
- Two (2) gas phase polyethylene manufacturing lines, 550,000 metric tons/yr each; VOC emission points controlled by the low pressure header system (LP System) or HP System, PM emission points controlled by filters.
- One (1) slurry technology polyethylene manufacturing line, 500,000 metric tons/yr; VOC emission points controlled by the LP System or HP System, PM emission points controlled by filters.
- One (1) LP System; routed to the LP incinerator, 10 tons/hr capacity, with backup multipoint ground flare (MPGF), 74 metric tons/hr capacity.
- One (1) HP System, 1,800 metric tons/hr capacity; routed to two (2) HP enclosed ground flares 150 metric tons/hr capacity each, with backup emergency elevated flare, 1,500 metric tons/hr capacity.
- Three (3) General Electric, Frame 6B, natural gas-fired combustion turbines, 40.6 MW (475 MMBtu/hr heat input rating) each, including natural gas- or tail gas-fired duct burners, 189 MMBtu/hr heat input rating each; controlled by SCR and oxidation catalysts.
- Four (4) diesel-fired emergency generator engines, 5,028 bhp rating each.
- Three (3) diesel-fired fire pump engines, 700 bhp rating each.
- One (1) process cooling tower, 28 cell counter-flow mechanical draft, 18.3 MMgal/hr water flow capacity; controlled by drift eliminators.
- One (1) cogen cooling tower, 6 cell counter-flow mechanical draft, 4.44 MMgal/hr water flow capacity; controlled by drift eliminators.
- Polyethylene pellet blending, handling, storage, and loadout; controlled by fabric filters.
- Liquid loadout, coke residue/tar and recovered oil; controlled by vapor capture and routing back to the process or Spent Caustic Vent incinerator, and low-leak couplings.
- Liquid loadout, pyrolysis fuel oil and light gasoline; controlled by vapor capture and routing to the LP System, and low-leak couplings.
- Liquid loadout, C3+; controlled by pressurized transfer with vapor balance and low-leak couplings.
- One (1) recovered oil, one (1) spent caustic, and two (2) equalization wastewater storage tanks, 23,775 to 742,324 gallon capacities; controlled by internal floating roofs (IFR) and vapor capture routed to the Spent Caustic Vent incinerator, 10.7 MMBtu/hr.
- One (1) light gasoline, and two (2) hexene storage tanks; 85,856 and 607,596 gallon capacities; controlled by IFR and vapor capture routed to the LP System.
- Two (2) pyrolysis fuel oil storage tanks; 85,856 gallon capacity; controlled by vapor capture routed to the LP System.
- Miscellaneous storage tanks, diesel fuel, 1,849 to 10,038 gallon capacities; controlled by carbon canisters.
- Miscellaneous components in gas, light liquid, and heavy liquid service; controlled by leak detection and repair (LDAR).
- Wastewater treatment plant (WWTP).

**SECTION C. Site Level Plan Approval Requirements**

- Plant roadways; controlled by paving and a road dust control plan including sweeping and watering (as necessary).

**# 031 [25 Pa. Code §127.12b]****Plan approval terms and conditions.**

The Owner/Operator shall inform the Department of the specific make and model of equipment and design details prior to startup for all air contamination sources and all air cleaning devices listed in Section A of this Plan Approval by submitting appropriate pages of the Plan Approval application forms.

**# 032 [25 Pa. Code §127.12b]****Plan approval terms and conditions.**

Upon determination by the Owner/Operator that the source(s) covered by this Plan Approval are in compliance with all operative conditions of the Plan Approval the Owner/Operator shall contact the Department and schedule the Initial Operating Permit Inspection.

**# 033 [25 Pa. Code §127.12b]****Plan approval terms and conditions.**

Upon completion of the Initial Operating Permit Inspection and determination by the Department that the source(s) covered by this Plan Approval are in compliance with all conditions of the Plan Approval the Owner/Operator shall submit a Title V Operating Permit application for this Facility.

**# 034 [25 Pa. Code §127.12b]****Plan approval terms and conditions.**

If, at any time, the Department has cause to believe that air contaminant emissions from the sources listed in this Plan Approval may be in excess of the limitations specified in, or established pursuant to this plan approval or the permittee's operating permit, the permittee may be required to conduct test methods and procedures deemed necessary by the Department to determine the actual emissions rate. Such testing shall be conducted in accordance with 25 Pa. Code Chapter 139, where applicable, and in accordance with any restrictions or limitations established by the Department at such time as it notifies the company that testing is required.

**# 035 [25 Pa. Code §127.12b]****Plan approval terms and conditions.**

The Owner/Operator shall conduct an inhalation risk assessment for the Facility based upon the final as-built design parameters of the air contamination sources. The inhalation risk assessment shall be conducted in accordance with the protocol previously submitted to the Department on January 7, 2015, which has already been approved. The inhalation risk assessment shall be submitted to the Department within 180 days of startup of the Facility.

**# 036 [25 Pa. Code §127.12b]****Plan approval terms and conditions.**

This Plan Approval is to allow the construction and temporary operation of a petrochemicals complex by Shell Chemical Appalachia LLC to be located in Potter and Center Townships, Beaver County.

**# 037 [25 Pa. Code §127.206]****ERC general requirements.**

The Owner/Operator is approved to use NOx ERCs in place of VOC ERCs at a 1:1 ratio to satisfy VOC emission offsetting requirements in this Plan Approval.

**# 038 [25 Pa. Code §127.206]****ERC general requirements.**

The Owner/Operator shall secure 400 tons of NOx, 620 tons of VOC, and 159 tons of PM2.5 ERCs. ERCs shall be properly generated, certified by the Department and processed through the registry in accordance with 25 Pa. Code §127.206(d)(1). Upon transfer, the Owner/Operator shall provide the Department with documentation clearly specifying the details of the ERC transaction. This facility may not commence operation until the required emissions reductions are certified and registered by the Department. All required ERCs have been secured by the Owner/Operator and incorporated into this Plan Approval in accordance with 25 Pa. Code §127.208(2).

**# 039 [25 Pa. Code §127.208]****ERC use and transfer requirements.**

**SECTION C. Site Level Plan Approval Requirements**

The use and transfer of ERCs shall meet the following conditions:

- (1) The registry system established by § 127.209 (relating to ERC registry system) shall be used to transfer ERCs, with the Department's approval, directly from an existing source or facility where the ERCs were generated to the proposed facility.
- (2) The transferee shall secure approval to use the offsetting ERCs through a plan approval or an operating permit, which indicates the Department's approval of the ERC transfer and use. Upon the issuance of a plan approval or an operating permit, the ERCs are no longer subject to expiration under § 127.206(f) (relating to ERC general requirements) except as specified in § 127.206(g).
- (3) For the pollutants regulated under this subchapter, the facility shall demonstrate to the satisfaction of the Department that the ERCs proposed for use as offsets will provide, at a minimum, ambient impact equivalence to the extent equivalence can be determined and that the use of the ERCs will not interfere with the overall control strategy of the SIP.
- (4) ERCs shall include the same conditions, limitations and characteristics, including seasonal and other temporal variations in emission rate and quality, as well as the maximum allowable emission rates the emissions would have had if emitted by the generator, unless equivalent ambient impact is assured through other means.
- (5) ERCs may be obtained from or traded in another state, which has reciprocity with the Commonwealth for the trading and use of ERCs, only upon the approval of both the Commonwealth and the other state through SIP approved rules and procedures, including an EPA approved SIP revision. ERCs generated in another state may not be traded into or used at a facility within this Commonwealth unless the ERC generating facility's ERCs are enforceable by the Department.
- (6) ERCs may not be transferred to and used in an area with a higher nonattainment classification than the one in which they were generated.
- (7) A facility proposing new or increased emissions shall demonstrate that sufficient offsetting ERCs at the ratio specified in § 127.210 (relating to offset ratios) have been acquired from within the nonattainment area of the proposed facility.
- (8) If the facility proposing new or increased emissions demonstrates that ERCs are not available in the nonattainment area where the facility is located, ERCs may be obtained from another nonattainment area if the other nonattainment area has an equal or higher classification and if the emissions from the other nonattainment area contribute to an NAAQS violation in the nonattainment area of the proposed facility. In addition, the requirements of paragraph (3) shall be satisfied.
- (9) For the purpose of emissions offset transfers at VOC or NO<sub>x</sub> facilities, the areas included within an ozone transport region established under section 184 of the Clean Air Act (42 U.S.C.A. § 7511c), which are designated in 40 CFR 81.339 (relating to Pennsylvania) as attainment, nonattainment or unclassifiable areas for ozone, shall be treated as a single nonattainment area.
- (10) An owner or operator of a facility shall acquire ERCs for use as offsets from an ERC generating facility located within the same nonattainment area.
- (11) An owner or operator of a facility shall acquire ERCs for use as offsets from an ERC generating facility located within the same nonattainment area, except that the Department may allow the owner or operator to obtain ERCs generated in another nonattainment area if the following exist:
  - (i) The other area has an equal or higher nonattainment classification than the area in which the facility is located.
  - (ii) Emissions from the other area contribute to a violation of the NAAQS in the nonattainment area in which the facility is located.
- (12) An owner or operator of a facility that is subject to allowance-based programs in this article may generate, create, transfer and use ERCs in accordance with this subchapter and applicable provisions in Chapter 145 (relating to interstate pollution transport reduction).

**SECTION C. Site Level Plan Approval Requirements****# 040 [25 Pa. Code §127.208]****ERC use and transfer requirements.**

The Owner/Operator has secured 24.05 tons of PM2.5, 9 tons of VOC, and 899.6 tons of NOx ERCs from the shutdown of the G.F. Weaton Power Plant in a transfer from Horsehead Corporation to Shell Chemical Appalachia LLC. All of these ERCs have been applied to this Plan Approval and are no longer subject to expiration under 25 Pa. Code §127.206(f) except as specified in §127.206(g) as long as they remain in this Plan Approval.

**# 041 [25 Pa. Code §127.208]****ERC use and transfer requirements.**

The Owner/Operator has secured 34.10 tons of PM2.5, 64 tons of VOC, and 211 tons of NOx ERCs from the shutdown of the Monaca Zinc Smelter in a transfer from Horsehead Corporation to Shell Chemical Appalachia LLC. Amounts of 3.78 tons of PM2.5 ERCs, 64 tons of VOC ERCs, and 13.4 tons of NOx ERCs have been applied to this Plan Approval and are no longer subject to expiration under 25 Pa. Code §127.206(f) except as specified in §127.206(g) as long as they remain in this Plan Approval. Amounts of 30.32 tons of PM2.5 ERCs and 197.6 tons of NOx ERCs remain secured by Shell but are not applied to this Plan Approval because they would exceed the total emissions offsetting requirement of this Plan Approval. Expiration of these ERCs remains April 26, 2024.

**# 042 [25 Pa. Code §127.208]****ERC use and transfer requirements.**

The Owner/Operator has secured 40.17 tons of adjusted PM2.5 and 10.18 tons of VOC ERCs from the shutdown of Armstrong Power Plant Unit 1 in a transfer from FirstEnergy Solutions Corporation to Shell Chemical Appalachia LLC. All of these ERCs have been applied to this Plan Approval and are no longer subject to expiration under 25 Pa. Code §127.206(f) except as specified in §127.206(g) as long as they remain in this Plan Approval.

**# 043 [25 Pa. Code §127.208]****ERC use and transfer requirements.**

The Owner/Operator has secured 91 tons of PM2.5 and 13 tons of VOC ERCs from the shutdown of Mitchell Power Plant Unit 3 in a transfer from FirstEnergy Solutions Corporation to Shell Chemical Appalachia LLC. All of these ERCs have been applied to this Plan Approval and are no longer subject to expiration under 25 Pa. Code §127.206(f) except as specified in §127.206(g) as long as they remain in this Plan Approval.

**# 044 [25 Pa. Code §127.208]****ERC use and transfer requirements.**

The Owner/Operator has secured 10.82 tons of VOC ERCs from the shutdown of Armstrong Power Plant Unit 2 in a transfer from FirstEnergy Solutions Corporation to Shell Chemical Appalachia LLC. All of these ERCs have been applied to this Plan Approval and are no longer subject to expiration under 25 Pa. Code §127.206(f) except as specified in §127.206(g) as long as they remain in this Plan Approval.

**# 045 [40 CFR Part 61 NESHAPs §40 CFR 61.340]****Subpart FF--National Emission Standard for Benzene Waste Operations Applicability.**

The site is subject to limited requirements of 40 CFR Part 61 Subpart FF – National Emission Standard for Benzene Waste Operations.

**# 046 [40 CFR Part 61 NESHAPs §40 CFR 61.340]****Subpart FF--National Emission Standard for Benzene Waste Operations Applicability.**

The following waste streams are exempt from the requirements of 40 CFR Part 61 Subpart FF:

- a. Waste in the form of gas or vapor emitted from process fluids.
- b. Waste that is contained in a segregated storm water sewer system.

**# 047 [40 CFR Part 61 NESHAPs §40 CFR 61.341]****Subpart FF--National Emission Standard for Benzene Waste Operations Definitions.**

All terms used in 40 CFR Part 61 Subpart FF shall have the meaning given in 40 CFR §61.341 or else in the Clean Air Act.

**SECTION C. Site Level Plan Approval Requirements****# 048 [40 CFR Part 61 NESHAPs §40 CFR 61.342]****Subpart FF--National Emission Standard for Benzene Waste Operations  
Standards: General.**

The Owner/Operator shall comply with the applicable general standards for a facility with benzene waste less than 10 Mg per year (11 tons per year) as specified in 40 CFR §61.342(a), (g), and (h).

**# 049 [40 CFR Part 64 Compliance Assurance Monitoring for Major Stationary Sources §40 CFR 64.4]****Sections of PART 64  
Submittal requirements**

The Owner/Operator shall comply with the applicable Compliance Assurance Monitoring (CAM) submittal requirements specified in 40 CFR §64.4.

**# 050 [40 CFR Part 64 Compliance Assurance Monitoring for Major Stationary Sources §40 CFR 64.5]****Sections of PART 64  
Deadlines for submittals**

The Owner/Operator shall comply with the applicable CAM information submittal deadlines (to be submitted with the initial Title V Operating Permit application) specified in 40 CFR §64.5.

**VIII. COMPLIANCE CERTIFICATION.**

No additional compliance certifications exist except as provided in other sections of this plan approval including Section B (relating to Plan Approval General Requirements).

**IX. COMPLIANCE SCHEDULE.**

No compliance milestones exist.

**SECTION D. Source Level Plan Approval Requirements**

Source ID: 031

Source Name: ETHANE CRACKING FURNACE #1

Source Capacity/Throughput: 620.000 MMBTU/HR

Conditions for this source occur in the following groups: G01

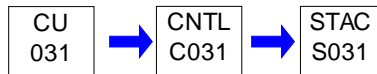
**I. RESTRICTIONS.**

No additional requirements exist except as provided in other sections of this plan approval including Section B (Plan Approval General Requirements) and/or Section E (Source Group Restrictions).

**II. TESTING REQUIREMENTS.**

No additional testing requirements exist except as provided in other sections of this plan approval including Section B (Plan Approval General Requirements) and/or Section E (Source Group Restrictions).

**III. MONITORING REQUIREMENTS.**

No additional monitoring requirements exist except as provided in other sections of this plan approval including Section B (Plan Approval General Requirements) and/or Section E (Source Group Restrictions).

**IV. RECORDKEEPING REQUIREMENTS.**

No additional record keeping requirements exist except as provided in other sections of this plan approval including Section B (Plan Approval General Requirements) and/or Section E (Source Group Restrictions).

**V. REPORTING REQUIREMENTS.**

No additional reporting requirements exist except as provided in other sections of this plan approval including Section B (Plan Approval General Requirements) and/or Section E (Source Group Restrictions).

**VI. WORK PRACTICE REQUIREMENTS.**

No additional work practice requirements exist except as provided in other sections of this plan approval including Section B (Plan Approval General Requirements) and/or Section E (Source Group Restrictions).

**VII. ADDITIONAL REQUIREMENTS.**

No additional requirements exist except as provided in other sections of this plan approval including Section B (Plan Approval General Requirements) and/or Section E (Source Group Restrictions).

**SECTION D. Source Level Plan Approval Requirements**

Source ID: 032

Source Name: ETHANE CRACKING FURNACE #2

Source Capacity/Throughput: 620.000 MMBTU/HR

Conditions for this source occur in the following groups: G01

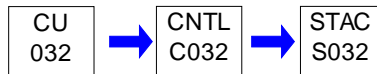
**I. RESTRICTIONS.**

No additional requirements exist except as provided in other sections of this plan approval including Section B (Plan Approval General Requirements) and/or Section E (Source Group Restrictions).

**II. TESTING REQUIREMENTS.**

No additional testing requirements exist except as provided in other sections of this plan approval including Section B (Plan Approval General Requirements) and/or Section E (Source Group Restrictions).

**III. MONITORING REQUIREMENTS.**

No additional monitoring requirements exist except as provided in other sections of this plan approval including Section B (Plan Approval General Requirements) and/or Section E (Source Group Restrictions).

**IV. RECORDKEEPING REQUIREMENTS.**

No additional record keeping requirements exist except as provided in other sections of this plan approval including Section B (Plan Approval General Requirements) and/or Section E (Source Group Restrictions).

**V. REPORTING REQUIREMENTS.**

No additional reporting requirements exist except as provided in other sections of this plan approval including Section B (Plan Approval General Requirements) and/or Section E (Source Group Restrictions).

**VI. WORK PRACTICE REQUIREMENTS.**

No additional work practice requirements exist except as provided in other sections of this plan approval including Section B (Plan Approval General Requirements) and/or Section E (Source Group Restrictions).

**VII. ADDITIONAL REQUIREMENTS.**

No additional requirements exist except as provided in other sections of this plan approval including Section B (Plan Approval General Requirements) and/or Section E (Source Group Restrictions).

**SECTION D. Source Level Plan Approval Requirements**

Source ID: 033

Source Name: ETHANE CRACKING FURNACE #3

Source Capacity/Throughput: 620.000 MMBTU/HR

Conditions for this source occur in the following groups: G01

**I. RESTRICTIONS.**

No additional requirements exist except as provided in other sections of this plan approval including Section B (Plan Approval General Requirements) and/or Section E (Source Group Restrictions).

**II. TESTING REQUIREMENTS.**

No additional testing requirements exist except as provided in other sections of this plan approval including Section B (Plan Approval General Requirements) and/or Section E (Source Group Restrictions).

**III. MONITORING REQUIREMENTS.**

No additional monitoring requirements exist except as provided in other sections of this plan approval including Section B (Plan Approval General Requirements) and/or Section E (Source Group Restrictions).

**IV. RECORDKEEPING REQUIREMENTS.**

No additional record keeping requirements exist except as provided in other sections of this plan approval including Section B (Plan Approval General Requirements) and/or Section E (Source Group Restrictions).

**V. REPORTING REQUIREMENTS.**

No additional reporting requirements exist except as provided in other sections of this plan approval including Section B (Plan Approval General Requirements) and/or Section E (Source Group Restrictions).

**VI. WORK PRACTICE REQUIREMENTS.**

No additional work practice requirements exist except as provided in other sections of this plan approval including Section B (Plan Approval General Requirements) and/or Section E (Source Group Restrictions).

**VII. ADDITIONAL REQUIREMENTS.**

No additional requirements exist except as provided in other sections of this plan approval including Section B (Plan Approval General Requirements) and/or Section E (Source Group Restrictions).

**SECTION D. Source Level Plan Approval Requirements**

Source ID: 034

Source Name: ETHANE CRACKING FURNACE #4

Source Capacity/Throughput: 620.000 MMBTU/HR

Conditions for this source occur in the following groups: G01

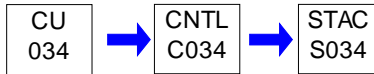
**I. RESTRICTIONS.**

No additional requirements exist except as provided in other sections of this plan approval including Section B (Plan Approval General Requirements) and/or Section E (Source Group Restrictions).

**II. TESTING REQUIREMENTS.**

No additional testing requirements exist except as provided in other sections of this plan approval including Section B (Plan Approval General Requirements) and/or Section E (Source Group Restrictions).

**III. MONITORING REQUIREMENTS.**

No additional monitoring requirements exist except as provided in other sections of this plan approval including Section B (Plan Approval General Requirements) and/or Section E (Source Group Restrictions).

**IV. RECORDKEEPING REQUIREMENTS.**

No additional record keeping requirements exist except as provided in other sections of this plan approval including Section B (Plan Approval General Requirements) and/or Section E (Source Group Restrictions).

**V. REPORTING REQUIREMENTS.**

No additional reporting requirements exist except as provided in other sections of this plan approval including Section B (Plan Approval General Requirements) and/or Section E (Source Group Restrictions).

**VI. WORK PRACTICE REQUIREMENTS.**

No additional work practice requirements exist except as provided in other sections of this plan approval including Section B (Plan Approval General Requirements) and/or Section E (Source Group Restrictions).

**VII. ADDITIONAL REQUIREMENTS.**

No additional requirements exist except as provided in other sections of this plan approval including Section B (Plan Approval General Requirements) and/or Section E (Source Group Restrictions).

**SECTION D. Source Level Plan Approval Requirements**

Source ID: 035

Source Name: ETHANE CRACKING FURNACE #5

Source Capacity/Throughput: 620.000 MMBTU/HR

Conditions for this source occur in the following groups: G01

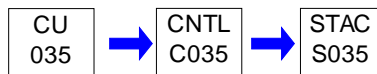
**I. RESTRICTIONS.**

No additional requirements exist except as provided in other sections of this plan approval including Section B (Plan Approval General Requirements) and/or Section E (Source Group Restrictions).

**II. TESTING REQUIREMENTS.**

No additional testing requirements exist except as provided in other sections of this plan approval including Section B (Plan Approval General Requirements) and/or Section E (Source Group Restrictions).

**III. MONITORING REQUIREMENTS.**

No additional monitoring requirements exist except as provided in other sections of this plan approval including Section B (Plan Approval General Requirements) and/or Section E (Source Group Restrictions).

**IV. RECORDKEEPING REQUIREMENTS.**

No additional record keeping requirements exist except as provided in other sections of this plan approval including Section B (Plan Approval General Requirements) and/or Section E (Source Group Restrictions).

**V. REPORTING REQUIREMENTS.**

No additional reporting requirements exist except as provided in other sections of this plan approval including Section B (Plan Approval General Requirements) and/or Section E (Source Group Restrictions).

**VI. WORK PRACTICE REQUIREMENTS.**

No additional work practice requirements exist except as provided in other sections of this plan approval including Section B (Plan Approval General Requirements) and/or Section E (Source Group Restrictions).

**VII. ADDITIONAL REQUIREMENTS.**

No additional requirements exist except as provided in other sections of this plan approval including Section B (Plan Approval General Requirements) and/or Section E (Source Group Restrictions).

**SECTION D. Source Level Plan Approval Requirements**

Source ID: 036

Source Name: ETHANE CRACKING FURNACE #6

Source Capacity/Throughput: 620.000 MMBTU/HR

Conditions for this source occur in the following groups: G01

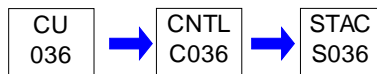
**I. RESTRICTIONS.**

No additional requirements exist except as provided in other sections of this plan approval including Section B (Plan Approval General Requirements) and/or Section E (Source Group Restrictions).

**II. TESTING REQUIREMENTS.**

No additional testing requirements exist except as provided in other sections of this plan approval including Section B (Plan Approval General Requirements) and/or Section E (Source Group Restrictions).

**III. MONITORING REQUIREMENTS.**

No additional monitoring requirements exist except as provided in other sections of this plan approval including Section B (Plan Approval General Requirements) and/or Section E (Source Group Restrictions).

**IV. RECORDKEEPING REQUIREMENTS.**

No additional record keeping requirements exist except as provided in other sections of this plan approval including Section B (Plan Approval General Requirements) and/or Section E (Source Group Restrictions).

**V. REPORTING REQUIREMENTS.**

No additional reporting requirements exist except as provided in other sections of this plan approval including Section B (Plan Approval General Requirements) and/or Section E (Source Group Restrictions).

**VI. WORK PRACTICE REQUIREMENTS.**

No additional work practice requirements exist except as provided in other sections of this plan approval including Section B (Plan Approval General Requirements) and/or Section E (Source Group Restrictions).

**VII. ADDITIONAL REQUIREMENTS.**

No additional requirements exist except as provided in other sections of this plan approval including Section B (Plan Approval General Requirements) and/or Section E (Source Group Restrictions).

**SECTION D. Source Level Plan Approval Requirements**

Source ID: 037

Source Name: ETHANE CRACKING FURNACE #7

Source Capacity/Throughput: 620.000 MMBTU/HR

Conditions for this source occur in the following groups: G01

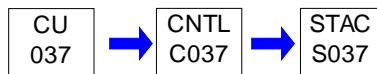
**I. RESTRICTIONS.**

No additional requirements exist except as provided in other sections of this plan approval including Section B (Plan Approval General Requirements) and/or Section E (Source Group Restrictions).

**II. TESTING REQUIREMENTS.**

No additional testing requirements exist except as provided in other sections of this plan approval including Section B (Plan Approval General Requirements) and/or Section E (Source Group Restrictions).

**III. MONITORING REQUIREMENTS.**

No additional monitoring requirements exist except as provided in other sections of this plan approval including Section B (Plan Approval General Requirements) and/or Section E (Source Group Restrictions).

**IV. RECORDKEEPING REQUIREMENTS.**

No additional record keeping requirements exist except as provided in other sections of this plan approval including Section B (Plan Approval General Requirements) and/or Section E (Source Group Restrictions).

**V. REPORTING REQUIREMENTS.**

No additional reporting requirements exist except as provided in other sections of this plan approval including Section B (Plan Approval General Requirements) and/or Section E (Source Group Restrictions).

**VI. WORK PRACTICE REQUIREMENTS.**

No additional work practice requirements exist except as provided in other sections of this plan approval including Section B (Plan Approval General Requirements) and/or Section E (Source Group Restrictions).

**VII. ADDITIONAL REQUIREMENTS.**

No additional requirements exist except as provided in other sections of this plan approval including Section B (Plan Approval General Requirements) and/or Section E (Source Group Restrictions).

**SECTION D. Source Level Plan Approval Requirements**

Source ID: 101

Source Name: COMBUSTION TURBINE/DUCT BURNER UNIT #1

Source Capacity/Throughput: 715.400 MMBTU/HR

Conditions for this source occur in the following groups: G02

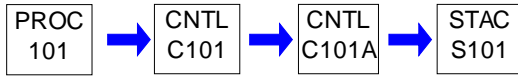
**I. RESTRICTIONS.**

No additional requirements exist except as provided in other sections of this plan approval including Section B (Plan Approval General Requirements) and/or Section E (Source Group Restrictions).

**II. TESTING REQUIREMENTS.**

No additional testing requirements exist except as provided in other sections of this plan approval including Section B (Plan Approval General Requirements) and/or Section E (Source Group Restrictions).

**III. MONITORING REQUIREMENTS.**

No additional monitoring requirements exist except as provided in other sections of this plan approval including Section B (Plan Approval General Requirements) and/or Section E (Source Group Restrictions).

**IV. RECORDKEEPING REQUIREMENTS.**

No additional record keeping requirements exist except as provided in other sections of this plan approval including Section B (Plan Approval General Requirements) and/or Section E (Source Group Restrictions).

**V. REPORTING REQUIREMENTS.**

No additional reporting requirements exist except as provided in other sections of this plan approval including Section B (Plan Approval General Requirements) and/or Section E (Source Group Restrictions).

**VI. WORK PRACTICE REQUIREMENTS.**

No additional work practice requirements exist except as provided in other sections of this plan approval including Section B (Plan Approval General Requirements) and/or Section E (Source Group Restrictions).

**VII. ADDITIONAL REQUIREMENTS.**

No additional requirements exist except as provided in other sections of this plan approval including Section B (Plan Approval General Requirements) and/or Section E (Source Group Restrictions).

**SECTION D. Source Level Plan Approval Requirements**

Source ID: 102

Source Name: COMBUSTION TURBINE/DUCT BURNER UNIT #2

Source Capacity/Throughput: 715.400 MMBTU/HR

Conditions for this source occur in the following groups: G02

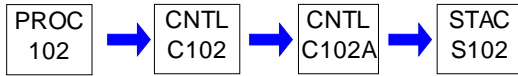
**I. RESTRICTIONS.**

No additional requirements exist except as provided in other sections of this plan approval including Section B (Plan Approval General Requirements) and/or Section E (Source Group Restrictions).

**II. TESTING REQUIREMENTS.**

No additional testing requirements exist except as provided in other sections of this plan approval including Section B (Plan Approval General Requirements) and/or Section E (Source Group Restrictions).

**III. MONITORING REQUIREMENTS.**

No additional monitoring requirements exist except as provided in other sections of this plan approval including Section B (Plan Approval General Requirements) and/or Section E (Source Group Restrictions).

**IV. RECORDKEEPING REQUIREMENTS.**

No additional record keeping requirements exist except as provided in other sections of this plan approval including Section B (Plan Approval General Requirements) and/or Section E (Source Group Restrictions).

**V. REPORTING REQUIREMENTS.**

No additional reporting requirements exist except as provided in other sections of this plan approval including Section B (Plan Approval General Requirements) and/or Section E (Source Group Restrictions).

**VI. WORK PRACTICE REQUIREMENTS.**

No additional work practice requirements exist except as provided in other sections of this plan approval including Section B (Plan Approval General Requirements) and/or Section E (Source Group Restrictions).

**VII. ADDITIONAL REQUIREMENTS.**

No additional requirements exist except as provided in other sections of this plan approval including Section B (Plan Approval General Requirements) and/or Section E (Source Group Restrictions).

**SECTION D. Source Level Plan Approval Requirements**

Source ID: 103

Source Name: COMBUSTION TURBINE/DUCT BURNER UNIT #3

Source Capacity/Throughput: 715.400 MMBTU/HR

Conditions for this source occur in the following groups: G02

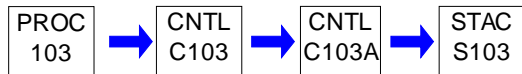
**I. RESTRICTIONS.**

No additional requirements exist except as provided in other sections of this plan approval including Section B (Plan Approval General Requirements) and/or Section E (Source Group Restrictions).

**II. TESTING REQUIREMENTS.**

No additional testing requirements exist except as provided in other sections of this plan approval including Section B (Plan Approval General Requirements) and/or Section E (Source Group Restrictions).

**III. MONITORING REQUIREMENTS.**

No additional monitoring requirements exist except as provided in other sections of this plan approval including Section B (Plan Approval General Requirements) and/or Section E (Source Group Restrictions).

**IV. RECORDKEEPING REQUIREMENTS.**

No additional record keeping requirements exist except as provided in other sections of this plan approval including Section B (Plan Approval General Requirements) and/or Section E (Source Group Restrictions).

**V. REPORTING REQUIREMENTS.**

No additional reporting requirements exist except as provided in other sections of this plan approval including Section B (Plan Approval General Requirements) and/or Section E (Source Group Restrictions).

**VI. WORK PRACTICE REQUIREMENTS.**

No additional work practice requirements exist except as provided in other sections of this plan approval including Section B (Plan Approval General Requirements) and/or Section E (Source Group Restrictions).

**VII. ADDITIONAL REQUIREMENTS.**

No additional requirements exist except as provided in other sections of this plan approval including Section B (Plan Approval General Requirements) and/or Section E (Source Group Restrictions).

**SECTION D. Source Level Plan Approval Requirements**

Source ID: 104

Source Name: COGENERATION PLANT COOLING TOWER

Source Capacity/Throughput:

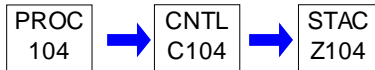
**I. RESTRICTIONS.****Emission Restriction(s).**

# 001 [25 Pa. Code §127.12b]

**Plan approval terms and conditions.**

Cooling tower water total dissolved solids (TDS) shall not exceed 2,000 ppmw on a monthly 12-month rolling average.

**Throughput Restriction(s).**

# 002 [25 Pa. Code §127.12b]

**Plan approval terms and conditions.**

Maximum designed water circulation rate through the cogen cooling tower shall not exceed 4,440,000 gallons per hour.

**Control Device Efficiency Restriction(s).**

# 003 [25 Pa. Code §127.12b]

**Plan approval terms and conditions.**

The cogen cooling tower shall be equipped with drift/mist eliminators designed not to exceed 0.0005% drift loss.

**II. TESTING REQUIREMENTS.**

# 004 [25 Pa. Code §127.12b]

**Plan approval terms and conditions.**

The Owner/Operator shall perform TDS and electrical conductivity testing upon the cogen cooling tower water according to ASTM Methods D5907-13 and D5391-14 (or other methods deemed acceptable by the Department). Samples and/or measurements for both tests are required to be performed under identical operating conditions, at a point which is representative of the water being evaporated to the atmosphere, and over the same time frame as applicable to each test method. A factor shall be derived from test results correlating TDS and electrical conductivity such that TDS may be approximated by future electrical conductivity measurements. Initial testing is required within 180 days of startup of the cooling towers or on an alternative schedule as approved by the Department. Subsequent TDS and electrical conductivity testing is required at minimum of once every 5 years thereafter. Extension to the initial and subsequent performance testing deadlines may be granted by the Department in writing in response to a written request from the Owner/Operator and upon a satisfactory showing that an extension is justified.

**III. MONITORING REQUIREMENTS.**

# 005 [25 Pa. Code §127.12b]

**Plan approval terms and conditions.**

The Owner/Operator shall, at a minimum of once per month, calculate TDS for the cogen cooling tower water. TDS shall be calculated by measuring electrical conductivity according to ASTM Method D5391-14 (or other method deemed acceptable by the Department) and multiplying the result by the correlation factor derived during the most recent simultaneous TDS and electrical conductivity test.

**IV. RECORDKEEPING REQUIREMENTS.**

No additional record keeping requirements exist except as provided in other sections of this plan approval including Section B (Plan Approval General Requirements).



## **SECTION D. Source Level Plan Approval Requirements**

### **V. REPORTING REQUIREMENTS.**

No additional reporting requirements exist except as provided in other sections of this plan approval including Section B (Plan Approval General Requirements).

### **VI. WORK PRACTICE REQUIREMENTS.**

No additional work practice requirements exist except as provided in other sections of this plan approval including Section B (Plan Approval General Requirements).

### **VII. ADDITIONAL REQUIREMENTS.**

No additional requirements exist except as provided in other sections of this plan approval including Section B (Plan Approval General Requirements).

**SECTION D. Source Level Plan Approval Requirements**

Source ID: 105

Source Name: DIESEL-FIRED EMERGENCY GENERATOR ENGINES (2)

Source Capacity/Throughput:

Conditions for this source occur in the following groups: G03

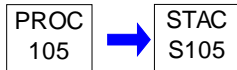
**I. RESTRICTIONS.**

No additional requirements exist except as provided in other sections of this plan approval including Section B (Plan Approval General Requirements) and/or Section E (Source Group Restrictions).

**II. TESTING REQUIREMENTS.**

No additional testing requirements exist except as provided in other sections of this plan approval including Section B (Plan Approval General Requirements) and/or Section E (Source Group Restrictions).

**III. MONITORING REQUIREMENTS.**

No additional monitoring requirements exist except as provided in other sections of this plan approval including Section B (Plan Approval General Requirements) and/or Section E (Source Group Restrictions).

**IV. RECORDKEEPING REQUIREMENTS.**

No additional record keeping requirements exist except as provided in other sections of this plan approval including Section B (Plan Approval General Requirements) and/or Section E (Source Group Restrictions).

**V. REPORTING REQUIREMENTS.**

No additional reporting requirements exist except as provided in other sections of this plan approval including Section B (Plan Approval General Requirements) and/or Section E (Source Group Restrictions).

**VI. WORK PRACTICE REQUIREMENTS.**

No additional work practice requirements exist except as provided in other sections of this plan approval including Section B (Plan Approval General Requirements) and/or Section E (Source Group Restrictions).

**VII. ADDITIONAL REQUIREMENTS.**

No additional requirements exist except as provided in other sections of this plan approval including Section B (Plan Approval General Requirements) and/or Section E (Source Group Restrictions).

**SECTION D. Source Level Plan Approval Requirements**

Source ID: 106

Source Name: FIRE PUMP ENGINES (2)

Source Capacity/Throughput:

Conditions for this source occur in the following groups: G03

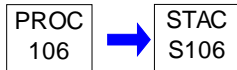
**I. RESTRICTIONS.**

No additional requirements exist except as provided in other sections of this plan approval including Section B (Plan Approval General Requirements) and/or Section E (Source Group Restrictions).

**II. TESTING REQUIREMENTS.**

No additional testing requirements exist except as provided in other sections of this plan approval including Section B (Plan Approval General Requirements) and/or Section E (Source Group Restrictions).

**III. MONITORING REQUIREMENTS.**

No additional monitoring requirements exist except as provided in other sections of this plan approval including Section B (Plan Approval General Requirements) and/or Section E (Source Group Restrictions).

**IV. RECORDKEEPING REQUIREMENTS.**

No additional record keeping requirements exist except as provided in other sections of this plan approval including Section B (Plan Approval General Requirements) and/or Section E (Source Group Restrictions).

**V. REPORTING REQUIREMENTS.**

No additional reporting requirements exist except as provided in other sections of this plan approval including Section B (Plan Approval General Requirements) and/or Section E (Source Group Restrictions).

**VI. WORK PRACTICE REQUIREMENTS.**

No additional work practice requirements exist except as provided in other sections of this plan approval including Section B (Plan Approval General Requirements) and/or Section E (Source Group Restrictions).

**VII. ADDITIONAL REQUIREMENTS.**

No additional requirements exist except as provided in other sections of this plan approval including Section B (Plan Approval General Requirements) and/or Section E (Source Group Restrictions).

**SECTION D. Source Level Plan Approval Requirements**

Source ID: 201

Source Name: ETHYLENE MANUFACTURING LINE

Source Capacity/Throughput:

Conditions for this source occur in the following groups: G04

G05

G06

G07

G08

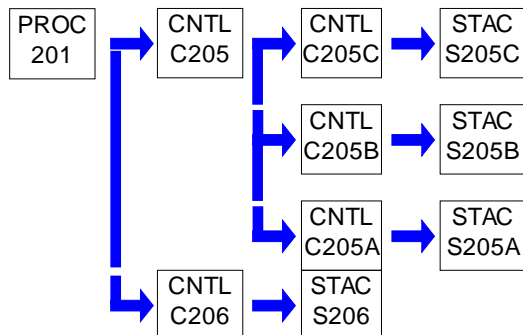
**I. RESTRICTIONS.****Control Device Efficiency Restriction(s).**

# 001 [25 Pa. Code §129.65]

**Ethylene production plants**

No person may permit the emission into the outdoor atmosphere of a waste gas stream from an ethylene production plant or facility unless the gas stream is properly burned at no less than 1,300°F for at least .3 seconds; except that no person may permit the emission of volatile organic compounds in gaseous form into the outdoor atmosphere from a vapor blowdown system unless these gases are burned by smokeless flares.

# 002 [40 CFR Part 60 Standards of Performance for New Stationary Sources §40 CFR 60.662]

**Subpart NNN - Standards of Performance for Volatile Organic Compound (VOC) Emissions From Synthetic Organic Chemical Manufacturing Industry (SOCMI) Distillation Operations Standards.**

The Owner/Operator shall comply with at least one of the applicable distillation unit vent stream standards specified in 40 CFR §60.662.

**II. TESTING REQUIREMENTS.**

# 003 [40 CFR Part 60 Standards of Performance for New Stationary Sources §40 CFR 60.664]

**Subpart NNN - Standards of Performance for Volatile Organic Compound (VOC) Emissions From Synthetic Organic Chemical Manufacturing Industry (SOCMI) Distillation Operations****Test methods and procedures.**

The Owner/Operator shall comply with the applicable test methods and procedures specified in 40 CFR §60.664.

**III. MONITORING REQUIREMENTS.**

# 004 [40 CFR Part 60 Standards of Performance for New Stationary Sources §40 CFR 60.663]

**Subpart NNN - Standards of Performance for Volatile Organic Compound (VOC) Emissions From Synthetic Organic Chemical Manufacturing Industry (SOCMI) Distillation Operations****Monitoring of emissions and operations.**

The Owner/Operator shall comply with the applicable monitoring of emissions and operations requirements for the chosen distillation unit vent stream standard as specified in 40 CFR §60.663.

**SECTION D. Source Level Plan Approval Requirements****IV. RECORDKEEPING REQUIREMENTS.**

No additional record keeping requirements exist except as provided in other sections of this plan approval including Section B (Plan Approval General Requirements) and/or Section E (Source Group Restrictions).

**V. REPORTING REQUIREMENTS.**

**# 005 [40 CFR Part 60 Standards of Performance for New Stationary Sources §40 CFR 60.665]  
Subpart NNN - Standards of Performance for Volatile Organic Compound (VOC) Emissions From Synthetic Organic Chemical Manufacturing Industry (SOCMI) Distillation Operations  
Reporting and recordkeeping requirements.**

The Owner/Operator shall comply with the applicable reporting and recordkeeping requirements specified in 40 CFR §60.665.

**# 006 [40 CFR Part 60 Standards of Performance for New Stationary Sources §40 CFR 60.705]  
Subpart RRR - Standards of Performance for Volatile Organic Compound Emission From Synthetic Organic Chemical Manufacturing Industry (SOCMI) Reactor Process  
Reporting and recordkeeping requirements.**

The Owner/Operator shall comply with the applicable reporting and recordkeeping requirements specified in 40 CFR §60.705(r).

**VI. WORK PRACTICE REQUIREMENTS.**

**# 007 [25 Pa. Code §127.12b]  
Plan approval terms and conditions.**

Spent caustic vent vapors shall be captured and routed through a closed system to the Spent Caustic Vent incinerator.

**# 008 [25 Pa. Code §127.12b]  
Plan approval terms and conditions.**

Compressor seal vent, startup, shutdown, and maintenance gases associated with the ethylene manufacturing line shall be captured and routed to the HP System. Emergency and malfunction event gases shall be captured and routed to the HP System as practicable. Hydrocarbon-containing equipment shall be drained, depressurized, and purged with nitrogen to the HP System prior to being opened to the atmosphere.

**VII. ADDITIONAL REQUIREMENTS.**

**# 009 [40 CFR Part 60 Standards of Performance for New Stationary Sources §40 CFR 60.660]  
Subpart NNN - Standards of Performance for Volatile Organic Compound (VOC) Emissions From Synthetic Organic Chemical Manufacturing Industry (SOCMI) Distillation Operations  
Applicability and designation of affected facility.**

The ethylene manufacturing line distillation units are subject to the requirements of 40 CFR Part 60 Subpart NNN - Standards of Performance for Volatile Organic Compound (VOC) Emissions From Synthetic Organic Chemical Manufacturing Industry (SOCMI) Distillation Operations.

**# 010 [40 CFR Part 60 Standards of Performance for New Stationary Sources §40 CFR 60.661]  
Subpart NNN - Standards of Performance for Volatile Organic Compound (VOC) Emissions From Synthetic Organic Chemical Manufacturing Industry (SOCMI) Distillation Operations  
Definitions.**

All terms used in 40 CFR Part 60 Subpart NNN shall have the meaning given in 40 CFR §60.661 or else in the Clean Air Act and 40 CFR Part 60 Subpart A.

**# 011 [40 CFR Part 60 Standards of Performance for New Stationary Sources §40 CFR 60.667]  
Subpart NNN - Standards of Performance for Volatile Organic Compound (VOC) Emissions From Synthetic Organic Chemical Manufacturing Industry (SOCMI) Distillation Operations  
Chemicals affected by subpart NNN.**

Chemicals affected by 40 CFR Part 60 Subpart NNN include ethylene and are listed in 40 CFR §60.667.

**SECTION D. Source Level Plan Approval Requirements****# 012 [40 CFR Part 60 Standards of Performance for New Stationary Sources §40 CFR 60.700]  
Subpart RRR - Standards of Performance for Volatile Organic Compound Emission From Synthetic Organic Chemical Manufacturing Industry (SOCMI) Reactor Process****Applicability and designation of affected facility.**

The ethylene manufacturing line reactor processes are subject to limited requirements of 40 CFR Part 60 Subpart RRR - Standards of Performance for Volatile Organic Compound Emissions From Synthetic Organic Chemical Manufacturing Industry (SOCMI) Reactor Processes.

**# 013 [40 CFR Part 60 Standards of Performance for New Stationary Sources §40 CFR 60.700]  
Subpart RRR - Standards of Performance for Volatile Organic Compound Emission From Synthetic Organic Chemical Manufacturing Industry (SOCMI) Reactor Process****Applicability and designation of affected facility.**

The Owner/Operator shall comply with the applicable exemption criteria specified in 40 CFR §60.700(c)(5).

**# 014 [40 CFR Part 60 Standards of Performance for New Stationary Sources §40 CFR 60.701]  
Subpart RRR - Standards of Performance for Volatile Organic Compound Emission From Synthetic Organic Chemical Manufacturing Industry (SOCMI) Reactor Process****Definitions.**

All terms used in 40 CFR Part 60 Subpart RRR shall have the meaning given in 40 CFR §60.701 or else in the Clean Air Act and 40 CFR Part 60 Subpart A.

**# 015 [40 CFR Part 60 Standards of Performance for New Stationary Sources §40 CFR 60.707]  
Subpart RRR - Standards of Performance for Volatile Organic Compound Emission From Synthetic Organic Chemical Manufacturing Industry (SOCMI) Reactor Process****Chemicals affected by Subpart RRR.**

Chemicals affected by 40 CFR Part 60 Subpart RRR include ethylene and are listed in 40 CFR §60.707.

**SECTION D. Source Level Plan Approval Requirements**

Source ID: 202

Source Name: POLYETHYLENE MANUFACTURING LINES

Source Capacity/Throughput:

Conditions for this source occur in the following groups: G08

G09

G12

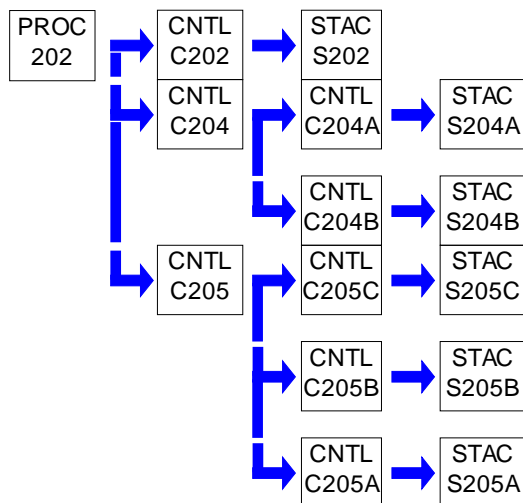
**I. RESTRICTIONS.****Emission Restriction(s).****# 001 [25 Pa. Code §127.12b]****Plan approval terms and conditions.**

Visible emissions from any fabric, sintered metal, or HEPA filter-controlled process vent shall not equal or exceed 10% opacity at any time.

**# 002 [25 Pa. Code §127.12b]****Plan approval terms and conditions.**

PM (filterable) emissions from each polyethylene manufacturing line pellet dryer vent shall not exceed 0.01 gr/dscf.

**Control Device Efficiency Restriction(s).****# 003 [25 Pa. Code §127.12b]****Plan approval terms and conditions.**

Polyethylene manufacturing line particulate matter process vents (excluding the pellet dryer vents) shall be equipped with and controlled by fabric, sintered metal, or HEPA filters.

**II. TESTING REQUIREMENTS.****# 004 [25 Pa. Code §127.12b]****Plan approval terms and conditions.**

The Owner/Operator shall perform chromium emission testing upon each polyethylene manufacturing line chromium catalyst activation vent according to the requirements of 25 Pa. Code Chapter 139 and a Department-approved pre-test protocol. Initial performance testing is required within 180 days of startup of each polyethylene manufacturing line or on an alternative schedule as approved by the Department. Subsequent performance testing is required at minimum of once every 5 years thereafter. Extension to the initial and subsequent performance testing deadlines may be granted by the Department in writing in response to a written request from the Owner/Operator and upon a satisfactory showing that an extension is justified.

**SECTION D. Source Level Plan Approval Requirements****# 005 [25 Pa. Code §127.12b]****Plan approval terms and conditions.**

The Owner/Operator shall perform PM (filterable) emission testing upon each polyethylene manufacturing line pellet dryer vent according to the requirements of 25 Pa. Code Chapter 139 and a Department-approved pre-test protocol. Initial performance testing is required within 180 days of startup of each polyethylene manufacturing line or on an alternative schedule as approved by the Department. Subsequent performance testing is required at a minimum of once every 5 years thereafter. Extension to the initial and subsequent performance testing deadlines may be granted by the Department in writing in response to a written request from the Owner/Operator and upon a satisfactory showing that an extension is justified.

**# 006 [40 CFR Part 60 Standards of Performance for New Stationary Sources §40 CFR 60.564]****Subpart DDD - Standards of Performance for Volatile Organic Compound (VOC) Emissions from the Polymer Manufacturing Industry****Test methods and procedures.**

The Owner/Operator shall comply with the applicable test methods and procedures specified in 40 CFR §60.564.

**III. MONITORING REQUIREMENTS.****# 007 [40 CFR Part 60 Standards of Performance for New Stationary Sources §40 CFR 60.563]****Subpart DDD - Standards of Performance for Volatile Organic Compound (VOC) Emissions from the Polymer Manufacturing Industry****Monitoring requirements.**

The Owner/Operator shall comply with the applicable monitoring requirements specified in 40 CFR §60.563.

**IV. RECORDKEEPING REQUIREMENTS.**

No additional record keeping requirements exist except as provided in other sections of this plan approval including Section B (Plan Approval General Requirements) and/or Section E (Source Group Restrictions).

**V. REPORTING REQUIREMENTS.****# 008 [40 CFR Part 60 Standards of Performance for New Stationary Sources §40 CFR 60.565]****Subpart DDD - Standards of Performance for Volatile Organic Compound (VOC) Emissions from the Polymer Manufacturing Industry****Reporting and recordkeeping requirements.**

The Owner/Operator shall comply with the applicable reporting and recordkeeping requirements specified in 40 CFR §60.565.

**VI. WORK PRACTICE REQUIREMENTS.****# 009 [25 Pa. Code §127.12b]****Plan approval terms and conditions.**

Compressor seal gas vents; intermittent VOC process vents; and startup, shutdown, and maintenance gases associated with the gas phase polyethylene manufacturing lines shall be routed to the HP System. Emergency and malfunction event gases shall be captured and routed to the HP System as practicable. Hydrocarbon-containing equipment shall be drained, depressurized, and purged with nitrogen to the HP System prior to being opened to the atmosphere.

**# 010 [25 Pa. Code §127.12b]****Plan approval terms and conditions.**

Fabric, sintered metal, and HEPA filters shall be designed not to exceed an outlet PM rate of 0.005 gr/dscf.

**# 011 [25 Pa. Code §127.12b]****Plan approval terms and conditions.**

Continuous VOC-containing process gas vents located upstream of and including the product purge bin in each gas phase technology polyethylene manufacturing line or upstream of the degasser in the slurry polyethylene manufacturing line shall be routed to the LP System.

**SECTION D. Source Level Plan Approval Requirements****# 012 [25 Pa. Code §127.12b]****Plan approval terms and conditions.**

Compressor seal gas vents; intermittent VOC process vents; and startup, shutdown, and maintenance gases associated with the slurry phase polyethylene manufacturing line shall be routed to the HP System. Emergency and malfunction event gases shall be captured and routed to the HP System as practicable. Hydrocarbon-containing equipment shall be drained, depressurized, and purged with nitrogen to the HP System prior to being opened to the atmosphere.

**# 013 [40 CFR Part 60 Standards of Performance for New Stationary Sources §40 CFR 60.562-1]****Subpart DDD - Standards of Performance for Volatile Organic Compound (VOC) Emissions from the Polymer Manufacturing Industry****Standards: Process emissions.**

The Owner/Operator shall comply with the applicable standards for polyethylene manufacturing process emissions specified in 40 CFR §60.562-1.

**# 014 [40 CFR Part 60 Standards of Performance for New Stationary Sources §40 CFR 60.562-2]****Subpart DDD - Standards of Performance for Volatile Organic Compound (VOC) Emissions from the Polymer Manufacturing Industry****Standards: Equipment leaks of VOC.**

The Owner/Operator shall comply with the applicable standards for polyethylene manufacturing equipment leaks of VOC specified in 40 CFR §60.562-2.

**VII. ADDITIONAL REQUIREMENTS.****# 015 [40 CFR Part 60 Standards of Performance for New Stationary Sources §40 CFR 60.560]****Subpart DDD - Standards of Performance for Volatile Organic Compound (VOC) Emissions from the Polymer Manufacturing Industry****Applicability and designation of affected facilities.**

The polyethylene manufacturing line affected process emissions and equipment leaks are subject to the requirements of 40 CFR Part 60 Subpart DDD - Standards of Performance for Volatile Organic Compound (VOC) Emissions from the Polymer Manufacturing Industry.

**# 016 [40 CFR Part 60 Standards of Performance for New Stationary Sources §40 CFR 60.561]****Subpart DDD - Standards of Performance for Volatile Organic Compound (VOC) Emissions from the Polymer Manufacturing Industry****Definitions.**

All terms used in 40 CFR Part 60 Subpart DDD shall have the meaning given in 40 CFR §60.561 or else in the Clean Air Act or 40 CFR Part 60 Subparts A or VV.

**SECTION D. Source Level Plan Approval Requirements**

Source ID: 203

Source Name: PROCESS COOLING TOWER

Source Capacity/Throughput:

Conditions for this source occur in the following groups: G05

G06

G09

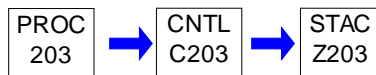
**I. RESTRICTIONS.****Emission Restriction(s).****# 001 [25 Pa. Code §127.12b]****Plan approval terms and conditions.**

Cooling tower water total dissolved solids (TDS) shall not exceed 2,000 ppmw on a monthly 12-month rolling average.

**# 002 [25 Pa. Code §127.12b]****Plan approval terms and conditions.**

Process cooling tower water VOC content shall not exceed 0.5 lb/MMgal.

**Throughput Restriction(s).****# 003 [25 Pa. Code §127.12b]****Plan approval terms and conditions.**

Maximum designed water circulation rate through the process cooling tower shall not exceed 18,600,000 gallons per hour.

**Control Device Efficiency Restriction(s).****# 004 [25 Pa. Code §127.12b]****Plan approval terms and conditions.**

The process cooling tower shall be equipped with drift/mist eliminators designed not to exceed 0.0005% drift loss.

**II. TESTING REQUIREMENTS.****# 005 [25 Pa. Code §127.12b]****Plan approval terms and conditions.**

The Owner/Operator shall perform TDS and electrical conductivity testing upon the process cooling tower water according to ASTM Methods D5907-13 and D5391-14 (or other methods deemed acceptable by the Department). Samples and/or measurements for both tests are required to be performed under identical operating conditions, at a point which is representative of the water being evaporated to the atmosphere, and over the same time frame as applicable to each test method. A factor shall be derived from test results correlating TDS and electrical conductivity such that TDS may be approximated by future electrical conductivity measurements. Initial testing is required within 180 days of startup of the cooling towers or on an alternative schedule as approved by the Department. Subsequent TDS and electrical conductivity testing is required at minimum of once every 5 years thereafter. Extension to the initial and subsequent performance testing deadlines may be granted by the Department in writing in response to a written request from the Owner/Operator and upon a satisfactory showing that an extension is justified.

**III. MONITORING REQUIREMENTS.****# 006 [25 Pa. Code §127.12b]****Plan approval terms and conditions.**

The Owner/Operator shall, at a minimum of once per month, calculate TDS for the process cooling tower water. TDS shall be calculated by measuring electrical conductivity according to ASTM Method D5391-14 (or other method deemed acceptable by the Department) and multiplying the result by the correlation factor derived during the most recent

**SECTION D. Source Level Plan Approval Requirements**

simultaneous TDS and electrical conductivity test.

**IV. RECORDKEEPING REQUIREMENTS.**

No additional record keeping requirements exist except as provided in other sections of this plan approval including Section B (Plan Approval General Requirements) and/or Section E (Source Group Restrictions).

**V. REPORTING REQUIREMENTS.**

No additional reporting requirements exist except as provided in other sections of this plan approval including Section B (Plan Approval General Requirements) and/or Section E (Source Group Restrictions).

**VI. WORK PRACTICE REQUIREMENTS.****# 007 [25 Pa. Code §127.12b]****Plan approval terms and conditions.**

The Owner/Operator shall develop and implement a leak detection and repair (LDAR) program for the process cooling tower heat exchange system. The developed LDAR program shall be submitted to the Department for review prior to implementation and at a minimum of 45 days prior to facility startup. Cooling water shall be monitored for VOC. Other aspects of the LDAR program shall be consistent with the "heat exchange system requirements" under 40 CFR Part 63 Subpart XX.

**VII. ADDITIONAL REQUIREMENTS.**

No additional requirements exist except as provided in other sections of this plan approval including Section B (Plan Approval General Requirements) and/or Section E (Source Group Restrictions).

**SECTION D. Source Level Plan Approval Requirements**

Source ID: 204

Source Name: CVTO HEADER SYSTEM

Source Capacity/Throughput:

Conditions for this source occur in the following groups: G08

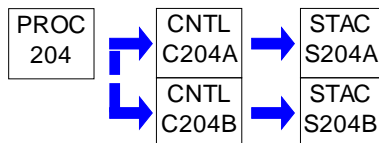
**I. RESTRICTIONS.****Emission Restriction(s).****# 001 [25 Pa. Code §127.12b]****Plan approval terms and conditions.**

Visible emissions from both the LP incinerator and MPGF shall not exceed 0% except for a total of five minutes during any consecutive two-hour period.

**# 002 [25 Pa. Code §127.12b]****Plan approval terms and conditions.**

Emissions from the LP incinerator shall not exceed the following:

- NO<sub>x</sub> - 0.068 lb/MMBtu
- CO - 0.0824 lb/MMBtu
- PM<sub>10</sub> - 0.0075 lb/MMBtu
- PM<sub>2.5</sub> - 0.0075 lb/MMBtu

**Control Device Efficiency Restriction(s).****# 003 [25 Pa. Code §127.12b]****Plan approval terms and conditions.**

The LP incinerator shall be designed and operated to reduce collected VOC emissions by a minimum of 99.9%.

**# 004 [25 Pa. Code §127.12b]****Plan approval terms and conditions.**

The MPGF shall be designed and operated to reduce collected VOC emissions by a minimum of 98%.

**II. TESTING REQUIREMENTS.****# 005 [25 Pa. Code §127.12b]****Plan approval terms and conditions.**

The Owner/Operator shall perform NO<sub>x</sub>, CO, PM<sub>10</sub>, and PM<sub>2.5</sub> emission testing upon the LP incinerator according to the requirements of 25 Pa. Code Chapter 139. Initial performance testing is required within 180 days of startup of the LP incinerator or on an alternative schedule as approved by the Department. Subsequent performance testing is required at minimum of once every 5 years thereafter. Extension to the initial and subsequent performance testing deadlines may be granted by the Department in writing in response to a written request from the Owner/Operator and upon a satisfactory showing that an extension is justified. EPA Reference Method performance testing shall be conducted for the initial and subsequent performance tests.

**# 006 [25 Pa. Code §127.12b]****Plan approval terms and conditions.**

The Owner/Operator shall perform VOC destruction efficiency testing upon the LP incinerator in accordance with 40 CFR §63.985(b)(1)(ii). Initial performance testing is required within 180 days of startup of the LP incinerator or on an alternative schedule as approved by the Department. Subsequent performance testing is required at a minimum of once every 5 years thereafter. Extension of the initial and subsequent performance testing deadlines may be granted by the Department in writing in response to a written request from the Owner/Operator and upon a satisfactory showing that an extension is

**SECTION D. Source Level Plan Approval Requirements**

justified.

**III. MONITORING REQUIREMENTS.****# 007 [25 Pa. Code §127.12b]****Plan approval terms and conditions.**

Monitoring for compliance with the 99.9% destruction efficiency requirement for the LP incinerator shall be performed in accordance with 40 CFR §63.985(c). Operating parameter monitoring shall include combustion temperature at a minimum.

**# 008 [25 Pa. Code §127.12b]****Plan approval terms and conditions.**

Monitoring for compliance with the 98% destruction efficiency requirement for the MPGF shall be performed in accordance with 40 CFR §63.987(c). Operating parameter monitoring shall include flame detection at a minimum.

**# 009 [25 Pa. Code §127.12b]****Plan approval terms and conditions.**

The Owner/Operator shall comply with the applicable flare monitoring and work practice requirements, including limits on maximum exit velocity and minimum net heating value requirements, specified in 40 CFR §60.18(c) through (f) and 40 CFR §63.11(b).

**# 010 [25 Pa. Code §127.12b]****Plan approval terms and conditions.**

Net heating value of the combustion zone gas at the MPGF header shall be measured and recorded at a minimum of once every 15 minutes. An adjusted net heating value of hydrogen of 1,212 Btu/scf may be used for this calculation.

**IV. RECORDKEEPING REQUIREMENTS.**

No additional record keeping requirements exist except as provided in other sections of this plan approval including Section B (Plan Approval General Requirements) and/or Section E (Source Group Restrictions).

**V. REPORTING REQUIREMENTS.**

No additional reporting requirements exist except as provided in other sections of this plan approval including Section B (Plan Approval General Requirements) and/or Section E (Source Group Restrictions).

**VI. WORK PRACTICE REQUIREMENTS.****# 011 [25 Pa. Code §127.12b]****Plan approval terms and conditions.**

The LP incinerator shall, at all times that vapors are being collected by the LP System, be operated at or above the minimum temperature at which at least 99.9% destruction efficiency is guaranteed by the manufacturer or demonstrated during performance testing.

**# 012 [25 Pa. Code §127.12b]****Plan approval terms and conditions.**

The MPGF shall be equipped with automated controls for control of the supplemental gas flow rate to the flare.

**# 013 [25 Pa. Code §127.12b]****Plan approval terms and conditions.**

The Owner/Operator shall minimize flaring resulting from startups, shutdowns, and unforeseeable events by operating at all times in accordance with an approved flare minimization plan. The plan shall include the following:

- a. Procedures for operating and maintaining the HP and LP Systems during periods of process unit startup, shutdown, and unforeseeable events.

**SECTION D. Source Level Plan Approval Requirements**

- b. A program of corrective action for malfunctioning process equipment.
- c. Procedures to minimize discharges either directly to the atmosphere or to the HP and LP Systems during the planned and unplanned startup or shutdown of process unit and air pollution control equipment.
- d. Procedures for conducting root cause analyses.
- e. Procedures for taking identified corrective actions.
- f. The baseline flow to the HP and LP Systems determined in accordance with the provisions of 40 CFR §60.103a(a)(4).

**# 014 [25 Pa. Code §127.12b]****Plan approval terms and conditions.**

The Owner/Operator shall conduct a root cause analysis within 45 days after any startup flaring event, shutdown flaring event, or unforeseeable flaring event. Flaring event shall be defined as an event that exceeds the baseline by 500,000 scf within a 24 hour period. The analysis shall address the following:

- a. The date and time that the flaring event started and ended.
- b. The total quantity of gas flared during each event.
- c. An estimate of the quantity of VOC that was emitted and the calculations used to determine the quantities.
- d. The steps taken to limit the duration of the flaring event of the quantity of emissions associated with the event.
- e. A detailed analysis that sets forth the root cause and all significant contributing causes of the flaring event to the extent determinable.
- f. An analyses of the measures that are available to reduce the likelihood of a recurrence of a flaring event resulting from the same root cause or significant contributing causes in the future.
- g. A demonstration that the actions taken during the flaring event are consistent with the procedures specified in the flare minimization plan.
- h. In response to a flaring event, the Owner/Operator shall implement, as expeditiously as practicable, such interim and/or long-term corrective actions as are consistent with good engineering practice to minimize the likelihood of a recurrence of the root cause and all significant contributing causes of that flaring event.
- i. If any items required to be addressed in this analysis are still under investigation 45 days after the flaring event, the Owner/Operator shall include a statement of the anticipated date by which a follow-up report fully conforming to the requirements of this Condition shall be completed.

**# 015 [25 Pa. Code §127.12b]****Plan approval terms and conditions.**

Net heating value of the combustion zone gas at the MPGF header shall equal or exceed 500 Btu/scf on a three-hour rolling average, calculated every 15 minutes.

**VII. ADDITIONAL REQUIREMENTS.**

No additional requirements exist except as provided in other sections of this plan approval including Section B (Plan Approval General Requirements) and/or Section E (Source Group Restrictions).

**SECTION D. Source Level Plan Approval Requirements**

Source ID: 205

Source Name: HIGH PRESSURE (HP) HEADER SYSTEM

Source Capacity/Throughput:

Conditions for this source occur in the following groups: G08

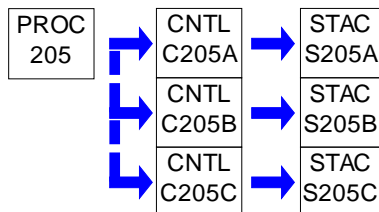
**I. RESTRICTIONS.****Emission Restriction(s).****# 001 [25 Pa. Code §127.12b]****Plan approval terms and conditions.**

Visible emissions from both the HP ground flares and emergency elevated flare shall not exceed 0% except for a total of five minutes during any consecutive two-hour period.

**Control Device Efficiency Restriction(s).****# 002 [25 Pa. Code §127.12b]****Plan approval terms and conditions.**

The HP ground flares and emergency elevated flare shall be designed and operated to reduce collected VOC emissions by a minimum of 98%.

**II. TESTING REQUIREMENTS.**

No additional testing requirements exist except as provided in other sections of this plan approval including Section B (Plan Approval General Requirements) and/or Section E (Source Group Restrictions).

**III. MONITORING REQUIREMENTS.****# 003 [25 Pa. Code §127.12b]****Plan approval terms and conditions.**

Net heating value of the combustion zone gas at the HP ground flare header shall be measured and recorded at a minimum of once every 15 minutes. An adjusted net heating value of hydrogen of 1,212 Btu/scf may be used for this calculation.

**# 004 [25 Pa. Code §127.12b]****Plan approval terms and conditions.**

Monitoring for compliance with the 98% destruction efficiency requirement for the HP ground flares shall be performed in accordance with 40 CFR §63.987(c). Operating parameter monitoring shall include flame detection at a minimum.

**# 005 [25 Pa. Code §127.12b]****Plan approval terms and conditions.**

The Owner/Operator shall comply with the applicable flare monitoring and work practice requirements, including limits on maximum exit velocity and minimum net heating value requirements, specified in 40 CFR §60.18(c) through (f) and 40 CFR §63.11(b).

**IV. RECORDKEEPING REQUIREMENTS.**

No additional record keeping requirements exist except as provided in other sections of this plan approval including Section B (Plan Approval General Requirements) and/or Section E (Source Group Restrictions).

**SECTION D. Source Level Plan Approval Requirements****V. REPORTING REQUIREMENTS.**

No additional reporting requirements exist except as provided in other sections of this plan approval including Section B (Plan Approval General Requirements) and/or Section E (Source Group Restrictions).

**VI. WORK PRACTICE REQUIREMENTS.****# 006 [25 Pa. Code §127.12b]****Plan approval terms and conditions.**

The Owner/Operator shall minimize flaring resulting from startups, shutdowns, and unforeseeable events by operating at all times in accordance with an approved flare minimization plan. The plan shall include the following:

- a. Procedures for operating and maintaining the HP and LP Systems during periods of process unit startup, shutdown, and unforeseeable events.
- b. A program of corrective action for malfunctioning process equipment.
- c. Procedures to minimize discharges either directly to the atmosphere or to the HP and LP Systems during the planned and unplanned startup or shutdown or process unit and air pollution control equipment.
- d. Procedures for conducting root cause analyses.
- e. Procedures for taking identified corrective actions.
- f. The baseline flow to the HP and LP Systems determined in accordance with the provisions of 40 CFR §60.103a(a)(4).

**# 007 [25 Pa. Code §127.12b]****Plan approval terms and conditions.**

The Owner/Operator shall conduct a root cause analysis within 45 days after any startup flaring event, shutdown flaring event, or unforeseeable flaring event. Flaring event shall be defined as an event that exceeds the baseline by 500,000 scf within a 24 hour period. The analysis shall address the following:

- a. The date and time that the flaring event started and ended.
- b. The total quantity of gas flared during each event.
- c. An estimate of the quantity of VOC that was emitted and the calculations used to determine the quantities.
- d. The steps taken to limit the duration of the flaring event or the quantity of emissions associated with the event.
- e. A detailed analysis that sets forth the root cause and all significant contributing causes of the flaring event to the extent determinable.
- f. An analyses of the measures that are available to reduce the likelihood of a recurrence of a flaring event resulting from the same root cause or significant contributing causes in the future.
- g. A demonstration that the actions taken during the flaring event are consistent with the procedures specified in the flare minimization plan.
- h. In response to a flaring event, the Owner/Operator shall implement, as expeditiously as practicable, such interim and/or long-term corrective actions as are consistent with good engineering practice to minimize the likelihood of a recurrence of the root cause and all significant contributing causes of that flaring event.
- i. If any items required to be addressed in this analysis are still under investigation 45 days after the flaring event, the Owner/Operator shall include a statement of the anticipated date by which a follow-up report fully conforming to the requirements of this Condition shall be completed.

**# 008 [25 Pa. Code §127.12b]****Plan approval terms and conditions.**

Net heating value of the combustion zone gas at the HP ground flare header shall equal or exceed 500 Btu/scf on a three-hour rolling average, calculated every 15 minutes.

**# 009 [25 Pa. Code §127.12b]****Plan approval terms and conditions.**

Vapors collected by the HP System shall only be routed to the HP elevated flare in the event that the combined capacities of the HP ground flares is exceeded due to malfunction or emergency, or due to maintenance of the HP ground flare(s).

**# 010 [25 Pa. Code §127.12b]****Plan approval terms and conditions.**

The HP ground flares shall be equipped with automated controls for control of the supplemental gas flow rate to the flares.

**SECTION D. Source Level Plan Approval Requirements****# 011 [25 Pa. Code §127.12b]****Plan approval terms and conditions.**

The emergency elevated flare shall be equipped with automated controls for control of the total steam mass flow rate to the flare.

**VII. ADDITIONAL REQUIREMENTS.**

No additional requirements exist except as provided in other sections of this plan approval including Section B (Plan Approval General Requirements) and/or Section E (Source Group Restrictions).

**SECTION D. Source Level Plan Approval Requirements**

Source ID: 206

Source Name: SPENT CAUSTIC VENT HEADER SYSTEM

Source Capacity/Throughput:

Conditions for this source occur in the following groups: G08

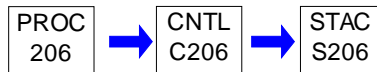
**I. RESTRICTIONS.****Emission Restriction(s).****# 001 [25 Pa. Code §127.12b]****Plan approval terms and conditions.**

Emissions from the Spent Caustic Vent incinerator shall not exceed the following:

- a. NO<sub>x</sub> - 0.068 lb/MMBtu
- b. CO - 0.0824 lb/MMBtu
- c. PM<sub>10</sub> - 0.0075 lb/MMBtu
- d. PM<sub>2.5</sub> - 0.0075 lb/MMBtu

**# 002 [25 Pa. Code §127.12b]****Plan approval terms and conditions.**

Visible emissions from the Spent Caustic Vent incinerator shall not exceed 0% except for a total of five minutes during any consecutive two-hour period.

**Control Device Efficiency Restriction(s).****# 003 [25 Pa. Code §127.12b]****Plan approval terms and conditions.**

The Spent Caustic Vent incinerator shall be operated to reduce collected VOC emissions by a minimum of 99%.

**II. TESTING REQUIREMENTS.****# 004 [25 Pa. Code §127.12b]****Plan approval terms and conditions.**

The Owner/Operator shall perform NO<sub>x</sub>, CO, PM<sub>10</sub>, and PM<sub>2.5</sub> emission testing upon the Spent Caustic Vent incinerator according to the requirements of 25 Pa. Code Chapter 139. Initial performance testing is required within 180 days of startup of the Spent Caustic Vent incinerator or on an alternative schedule as approved by the Department. Subsequent performance testing is required at minimum of once every 5 years thereafter. Extension to the initial and subsequent performance testing deadlines may be granted by the Department in writing in response to a written request from the Owner/Operator and upon a satisfactory showing that an extension is justified. EPA Reference Method performance testing shall be conducted for the initial and subsequent performance tests.

**# 005 [25 Pa. Code §127.12b]****Plan approval terms and conditions.**

The Owner/Operator shall perform VOC destruction efficiency testing upon the Spent Caustic Vent incinerator in accordance with 40 CFR §63.985(b)(1)(ii). Initial performance testing is required within 180 days of startup of the Spent Caustic Vent incinerator or on an alternative schedule as approved by the Department. Subsequent performance testing is required at a minimum of once every 5 years thereafter. Extension of the initial and subsequent performance testing deadlines may be granted by the Department in writing in response to a written request from the Owner/Operator and upon a satisfactory showing that an extension is justified.

**SECTION D. Source Level Plan Approval Requirements****III. MONITORING REQUIREMENTS.****# 006 [25 Pa. Code §127.12b]****Plan approval terms and conditions.**

Monitoring for compliance with the 99% destruction efficiency requirement for the Spent Caustic Vent incinerator shall be performed in accordance with 40 CFR §63.985(c). Operating parameter monitoring shall include combustion temperature at a minimum.

**IV. RECORDKEEPING REQUIREMENTS.**

No additional record keeping requirements exist except as provided in other sections of this plan approval including Section B (Plan Approval General Requirements) and/or Section E (Source Group Restrictions).

**V. REPORTING REQUIREMENTS.**

No additional reporting requirements exist except as provided in other sections of this plan approval including Section B (Plan Approval General Requirements) and/or Section E (Source Group Restrictions).

**VI. WORK PRACTICE REQUIREMENTS.****# 007 [25 Pa. Code §127.12b]****Plan approval terms and conditions.**

The Spent Caustic Vent incinerator shall, at all times that vapors are being collected, be operated at or above the minimum temperature at which at least 99% destruction efficiency is guaranteed by the manufacturer or demonstrated during performance testing.

**VII. ADDITIONAL REQUIREMENTS.**

No additional requirements exist except as provided in other sections of this plan approval including Section B (Plan Approval General Requirements) and/or Section E (Source Group Restrictions).

**SECTION D. Source Level Plan Approval Requirements**

Source ID: 301

Source Name: POLYETHYLENE PELLET MATERIAL STORAGE/HANDLING/LOADOUT

Source Capacity/Throughput:

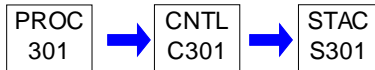
**I. RESTRICTIONS.****Emission Restriction(s).**

# 001 [25 Pa. Code §127.12b]

**Plan approval terms and conditions.**

Visible emissions from any fabric filter-controlled blending silo, handling and storage silos, or loadout operation shall not equal or exceed 10% opacity at any time.

# 002 [25 Pa. Code §127.12b]

**Plan approval terms and conditions.**

Polyethylene residual VOC content shall not exceed 50 ppmw on a monthly average for each polyethylene manufacturing line.\*

\*As measured downstream of the product purge bin in the gas phase technology polyethylene manufacturing line and downstream of and including the degasser at the slurry polyethylene manufacturing line

**Control Device Efficiency Restriction(s).**

# 003 [25 Pa. Code §127.12b]

**Plan approval terms and conditions.**

Fabric filters shall be designed not to exceed an outlet PM rate of 0.005 gr/dscf.

**II. TESTING REQUIREMENTS.**

# 004 [25 Pa. Code §127.12b]

**Plan approval terms and conditions.**

Polyethylene residual VOC content shall be measured no less than once per calendar month and once per product formulation change for each polyethylene manufacturing line. Measurement shall be conducted by methods and techniques acceptable to the Department. A minimum of three samples shall be taken before the first uncontrolled emission point downstream of the product purge bin in each gas phase technology polyethylene manufacturing line or downstream of the degasser in the slurry polyethylene manufacturing line for each measurement.

**III. MONITORING REQUIREMENTS.**

No additional monitoring requirements exist except as provided in other sections of this plan approval including Section B (Plan Approval General Requirements).

**IV. RECORDKEEPING REQUIREMENTS.**

No additional record keeping requirements exist except as provided in other sections of this plan approval including Section B (Plan Approval General Requirements).

**V. REPORTING REQUIREMENTS.**

No additional reporting requirements exist except as provided in other sections of this plan approval including Section B (Plan Approval General Requirements).

**SECTION D. Source Level Plan Approval Requirements****VI. WORK PRACTICE REQUIREMENTS.****# 005 [25 Pa. Code §127.12b]****Plan approval terms and conditions.**

Polyethylene pellet blending silos, handling, storage, and loadout shall be controlled by fabric filters and operated with no fugitive emissions.

**VII. ADDITIONAL REQUIREMENTS.**

No additional requirements exist except as provided in other sections of this plan approval including Section B (Plan Approval General Requirements).

**SECTION D. Source Level Plan Approval Requirements**

Source ID: 302

Source Name: LIQUID LOADOUT (RECOVERED OIL)

Source Capacity/Throughput:

Conditions for this source occur in the following groups: G05

G10

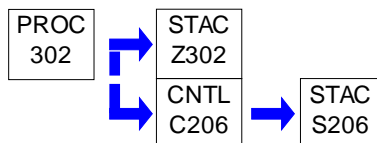
**I. RESTRICTIONS.**

No additional requirements exist except as provided in other sections of this plan approval including Section B (Plan Approval General Requirements) and/or Section E (Source Group Restrictions).

**II. TESTING REQUIREMENTS.**

No additional testing requirements exist except as provided in other sections of this plan approval including Section B (Plan Approval General Requirements) and/or Section E (Source Group Restrictions).

**III. MONITORING REQUIREMENTS.**

No additional monitoring requirements exist except as provided in other sections of this plan approval including Section B (Plan Approval General Requirements) and/or Section E (Source Group Restrictions).

**IV. RECORDKEEPING REQUIREMENTS.**

No additional record keeping requirements exist except as provided in other sections of this plan approval including Section B (Plan Approval General Requirements) and/or Section E (Source Group Restrictions).

**V. REPORTING REQUIREMENTS.**

No additional reporting requirements exist except as provided in other sections of this plan approval including Section B (Plan Approval General Requirements) and/or Section E (Source Group Restrictions).

**VI. WORK PRACTICE REQUIREMENTS.****# 001 [25 Pa. Code §127.12b]****Plan approval terms and conditions.**

Vapors displaced or generated by the loadout of recovered oil shall be captured and routed through a closed system to the Spent Caustic Vent incinerator.

**VII. ADDITIONAL REQUIREMENTS.**

No additional requirements exist except as provided in other sections of this plan approval including Section B (Plan Approval General Requirements) and/or Section E (Source Group Restrictions).

**SECTION D. Source Level Plan Approval Requirements**

Source ID: 303

Source Name: LIQUID LOADOUT (PYROLYSIS FO, LT GASOLINE, PE3 HEAVIES)

Source Capacity/Throughput:

Conditions for this source occur in the following groups: G05

G10

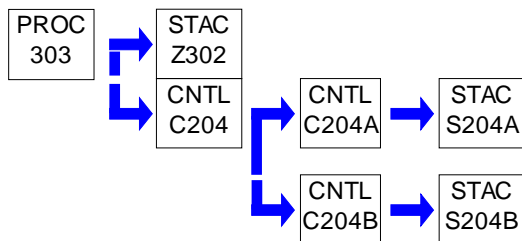
**I. RESTRICTIONS.**

No additional requirements exist except as provided in other sections of this plan approval including Section B (Plan Approval General Requirements) and/or Section E (Source Group Restrictions).

**II. TESTING REQUIREMENTS.**

No additional testing requirements exist except as provided in other sections of this plan approval including Section B (Plan Approval General Requirements) and/or Section E (Source Group Restrictions).

**III. MONITORING REQUIREMENTS.**

No additional monitoring requirements exist except as provided in other sections of this plan approval including Section B (Plan Approval General Requirements) and/or Section E (Source Group Restrictions).

**IV. RECORDKEEPING REQUIREMENTS.**

No additional record keeping requirements exist except as provided in other sections of this plan approval including Section B (Plan Approval General Requirements) and/or Section E (Source Group Restrictions).

**V. REPORTING REQUIREMENTS.**

No additional reporting requirements exist except as provided in other sections of this plan approval including Section B (Plan Approval General Requirements) and/or Section E (Source Group Restrictions).

**VI. WORK PRACTICE REQUIREMENTS.****# 001 [25 Pa. Code §127.12b]****Plan approval terms and conditions.**

Vapors displaced or generated by the loadout of pyrolysis fuel oil or light gasoline shall be captured and routed through a closed system to the LP System.

**VII. ADDITIONAL REQUIREMENTS.**

No additional requirements exist except as provided in other sections of this plan approval including Section B (Plan Approval General Requirements) and/or Section E (Source Group Restrictions).

**SECTION D. Source Level Plan Approval Requirements**

Source ID: 304

Source Name: LIQUID LOADOUT (C3+, BUTENE, ISOPENTANE, ISOBUTANE, C3 REF)

Source Capacity/Throughput:

Conditions for this source occur in the following groups: G05

G10

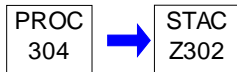
**I. RESTRICTIONS.**

No additional requirements exist except as provided in other sections of this plan approval including Section B (Plan Approval General Requirements) and/or Section E (Source Group Restrictions).

**II. TESTING REQUIREMENTS.**

No additional testing requirements exist except as provided in other sections of this plan approval including Section B (Plan Approval General Requirements) and/or Section E (Source Group Restrictions).

**III. MONITORING REQUIREMENTS.**

No additional monitoring requirements exist except as provided in other sections of this plan approval including Section B (Plan Approval General Requirements) and/or Section E (Source Group Restrictions).

**IV. RECORDKEEPING REQUIREMENTS.**

No additional record keeping requirements exist except as provided in other sections of this plan approval including Section B (Plan Approval General Requirements) and/or Section E (Source Group Restrictions).

**V. REPORTING REQUIREMENTS.**

No additional reporting requirements exist except as provided in other sections of this plan approval including Section B (Plan Approval General Requirements) and/or Section E (Source Group Restrictions).

**VI. WORK PRACTICE REQUIREMENTS.****# 001 [25 Pa. Code §127.12b]****Plan approval terms and conditions.**

C3+ liquids shall be loaded out with vapor balance to pressurized storage tanks capable of maintaining working pressures sufficient at all times to prevent vapor or gas loss to the atmosphere and with no venting during loading operations.

**# 002 [25 Pa. Code §127.12b]****Plan approval terms and conditions.**

Pressurized truck and rail storage tanks shall be equipped with pressure relief valves calibrated properly for the pressure level of the tank. Release of a pressure relief valve during loading shall cause the emergency shutdown of loading operations for that tank.

**VII. ADDITIONAL REQUIREMENTS.**

No additional requirements exist except as provided in other sections of this plan approval including Section B (Plan Approval General Requirements) and/or Section E (Source Group Restrictions).

**SECTION D. Source Level Plan Approval Requirements**

Source ID: 305

Source Name: LIQUID LOADOUT (BLENDED PITCH)

Source Capacity/Throughput:

Conditions for this source occur in the following groups: G05

G10

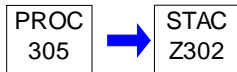
**I. RESTRICTIONS.**

No additional requirements exist except as provided in other sections of this plan approval including Section B (Plan Approval General Requirements) and/or Section E (Source Group Restrictions).

**II. TESTING REQUIREMENTS.**

No additional testing requirements exist except as provided in other sections of this plan approval including Section B (Plan Approval General Requirements) and/or Section E (Source Group Restrictions).

**III. MONITORING REQUIREMENTS.**

No additional monitoring requirements exist except as provided in other sections of this plan approval including Section B (Plan Approval General Requirements) and/or Section E (Source Group Restrictions).

**IV. RECORDKEEPING REQUIREMENTS.**

No additional record keeping requirements exist except as provided in other sections of this plan approval including Section B (Plan Approval General Requirements) and/or Section E (Source Group Restrictions).

**V. REPORTING REQUIREMENTS.**

No additional reporting requirements exist except as provided in other sections of this plan approval including Section B (Plan Approval General Requirements) and/or Section E (Source Group Restrictions).

**VI. WORK PRACTICE REQUIREMENTS.**

# 001 [25 Pa. Code §127.12b]

**Plan approval terms and conditions.**

Vapors displaced or generated by the loadout of coke residue/tar shall be captured and routed through a closed system back to the process.

**VII. ADDITIONAL REQUIREMENTS.**

No additional requirements exist except as provided in other sections of this plan approval including Section B (Plan Approval General Requirements) and/or Section E (Source Group Restrictions).

**SECTION D. Source Level Plan Approval Requirements**

Source ID: 401

Source Name: STORAGE TANKS (RECOVERED OIL, EQUALIZATION WASTEWATER)

Source Capacity/Throughput:

Conditions for this source occur in the following groups: G06

G09

G11

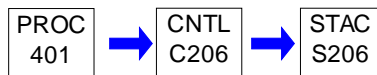
**I. RESTRICTIONS.**

No additional requirements exist except as provided in other sections of this plan approval including Section B (Plan Approval General Requirements) and/or Section E (Source Group Restrictions).

**II. TESTING REQUIREMENTS.**

No additional testing requirements exist except as provided in other sections of this plan approval including Section B (Plan Approval General Requirements) and/or Section E (Source Group Restrictions).

**III. MONITORING REQUIREMENTS.**

No additional monitoring requirements exist except as provided in other sections of this plan approval including Section B (Plan Approval General Requirements) and/or Section E (Source Group Restrictions).

**IV. RECORDKEEPING REQUIREMENTS.**

No additional record keeping requirements exist except as provided in other sections of this plan approval including Section B (Plan Approval General Requirements) and/or Section E (Source Group Restrictions).

**V. REPORTING REQUIREMENTS.**

No additional reporting requirements exist except as provided in other sections of this plan approval including Section B (Plan Approval General Requirements) and/or Section E (Source Group Restrictions).

**VI. WORK PRACTICE REQUIREMENTS.****# 001 [25 Pa. Code §127.12b]****Plan approval terms and conditions.**

Recovered oil and equalization wastewater storage tanks shall be equipped with an internal floating roof.

**# 002 [25 Pa. Code §127.12b]****Plan approval terms and conditions.**

Recovered oil and equalization wastewater storage tanks shall be controlled by vapor recovery routed to the Spent Caustic Vent incinerator.

**VII. ADDITIONAL REQUIREMENTS.**

No additional requirements exist except as provided in other sections of this plan approval including Section B (Plan Approval General Requirements) and/or Section E (Source Group Restrictions).

**SECTION D. Source Level Plan Approval Requirements**

Source ID: 402

Source Name: STORAGE TANK (SPENT CAUSTIC)

Source Capacity/Throughput:

Conditions for this source occur in the following groups: G05

G06

G11

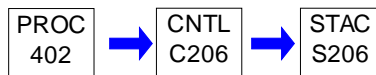
**I. RESTRICTIONS.**

No additional requirements exist except as provided in other sections of this plan approval including Section B (Plan Approval General Requirements) and/or Section E (Source Group Restrictions).

**II. TESTING REQUIREMENTS.**

No additional testing requirements exist except as provided in other sections of this plan approval including Section B (Plan Approval General Requirements) and/or Section E (Source Group Restrictions).

**III. MONITORING REQUIREMENTS.**

No additional monitoring requirements exist except as provided in other sections of this plan approval including Section B (Plan Approval General Requirements) and/or Section E (Source Group Restrictions).

**IV. RECORDKEEPING REQUIREMENTS.**

No additional record keeping requirements exist except as provided in other sections of this plan approval including Section B (Plan Approval General Requirements) and/or Section E (Source Group Restrictions).

**V. REPORTING REQUIREMENTS.**

No additional reporting requirements exist except as provided in other sections of this plan approval including Section B (Plan Approval General Requirements) and/or Section E (Source Group Restrictions).

**VI. WORK PRACTICE REQUIREMENTS.****# 001 [25 Pa. Code §127.12b]****Plan approval terms and conditions.**

The spent caustic storage tank shall be controlled by vapor recovery routed to the Spent Caustic Vent incinerator.

**# 002 [25 Pa. Code §127.12b]****Plan approval terms and conditions.**

The spent caustic storage tank shall be equipped with an internal floating roof.

**VII. ADDITIONAL REQUIREMENTS.**

No additional requirements exist except as provided in other sections of this plan approval including Section B (Plan Approval General Requirements) and/or Section E (Source Group Restrictions).

**SECTION D. Source Level Plan Approval Requirements**

Source ID: 403

Source Name: STORAGE TANKS (LIGHT GASOLINE)

Source Capacity/Throughput:

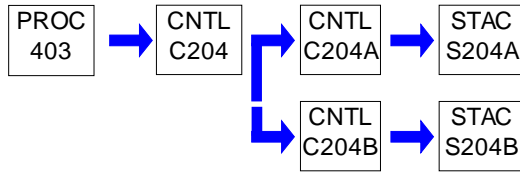
Conditions for this source occur in the following groups: G05  
G11**I. RESTRICTIONS.**

No additional requirements exist except as provided in other sections of this plan approval including Section B (Plan Approval General Requirements) and/or Section E (Source Group Restrictions).

**II. TESTING REQUIREMENTS.**

No additional testing requirements exist except as provided in other sections of this plan approval including Section B (Plan Approval General Requirements) and/or Section E (Source Group Restrictions).

**III. MONITORING REQUIREMENTS.**

No additional monitoring requirements exist except as provided in other sections of this plan approval including Section B (Plan Approval General Requirements) and/or Section E (Source Group Restrictions).

**IV. RECORDKEEPING REQUIREMENTS.**

No additional record keeping requirements exist except as provided in other sections of this plan approval including Section B (Plan Approval General Requirements) and/or Section E (Source Group Restrictions).

**V. REPORTING REQUIREMENTS.**

No additional reporting requirements exist except as provided in other sections of this plan approval including Section B (Plan Approval General Requirements) and/or Section E (Source Group Restrictions).

**VI. WORK PRACTICE REQUIREMENTS.****# 001 [25 Pa. Code §127.12b]****Plan approval terms and conditions.**

Light gasoline storage tanks shall be controlled by vapor recovery routed to the LP System.

**# 002 [25 Pa. Code §127.12b]****Plan approval terms and conditions.**

Light gasoline storage tanks shall be equipped with an internal floating roof.

**VII. ADDITIONAL REQUIREMENTS.**

No additional requirements exist except as provided in other sections of this plan approval including Section B (Plan Approval General Requirements) and/or Section E (Source Group Restrictions).

**SECTION D. Source Level Plan Approval Requirements**

Source ID: 404

Source Name: STORAGE TANKS (HEXENE)

Source Capacity/Throughput:

Conditions for this source occur in the following groups: G11

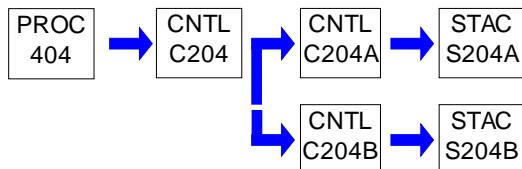
**I. RESTRICTIONS.**

No additional requirements exist except as provided in other sections of this plan approval including Section B (Plan Approval General Requirements) and/or Section E (Source Group Restrictions).

**II. TESTING REQUIREMENTS.**

**# 001 [40 CFR Part 60 Standards of Performance for New Stationary Sources §40 CFR 60.113b]**

**Subpart Kb - Standards of Performance for Volatile Organic Liquid Storage Vessels (Including Petroleum Liquid Storage Vessels) for Which Construction, Reconstruction, or Modification Commenced after July 23, 1984**

**Testing and procedures.**

The Owner/Operator shall comply with the applicable storage tank testing and procedures specified in 40 CFR §60.113b(a) and/or (c) or (d).

**III. MONITORING REQUIREMENTS.**

**# 002 [40 CFR Part 60 Standards of Performance for New Stationary Sources §40 CFR 60.116b]**

**Subpart Kb - Standards of Performance for Volatile Organic Liquid Storage Vessels (Including Petroleum Liquid Storage Vessels) for Which Construction, Reconstruction, or Modification Commenced after July 23, 1984**

**Monitoring of operations.**

The Owner/Operator shall comply with the applicable storage tank monitoring requirements specified in 40 CFR §60.116b.

**IV. RECORDKEEPING REQUIREMENTS.**

No additional record keeping requirements exist except as provided in other sections of this plan approval including Section B (Plan Approval General Requirements) and/or Section E (Source Group Restrictions).

**V. REPORTING REQUIREMENTS.**

**# 003 [40 CFR Part 60 Standards of Performance for New Stationary Sources §40 CFR 60.115b]**

**Subpart Kb - Standards of Performance for Volatile Organic Liquid Storage Vessels (Including Petroleum Liquid Storage Vessels) for Which Construction, Reconstruction, or Modification Commenced after July 23, 1984**

**Reporting and recordkeeping requirements.**

The Owner/Operator shall comply with the applicable storage tank reporting and recordkeeping requirements specified in 40 CFR §60.115b(a) and/or (c) or (d).

**VI. WORK PRACTICE REQUIREMENTS.**

**# 004 [25 Pa. Code §127.12b]**

**Plan approval terms and conditions.**

Hexene storage tanks shall be controlled by vapor recovery routed to the LP System.

**# 005 [25 Pa. Code §127.12b]**

**Plan approval terms and conditions.**

Hexene storage tanks shall be equipped with an internal floating roof.

**SECTION D. Source Level Plan Approval Requirements**

**# 006 [40 CFR Part 60 Standards of Performance for New Stationary Sources §40 CFR 60.112b]  
Subpart Kb - Standards of Performance for Volatile Organic Liquid Storage Vessels (Including Petroleum Liquid Storage Vessels) for Which Construction, Reconstruction, or Modification Commenced after July 23, 1984  
Standard for volatile organic compounds (VOC).**

The Owner/Operator shall comply with the applicable storage tank VOC standards specified in 40 CFR §60.112b(a).

**VII. ADDITIONAL REQUIREMENTS.**

**# 007 [40 CFR Part 60 Standards of Performance for New Stationary Sources §40 CFR 60.110b]  
Subpart Kb - Standards of Performance for Volatile Organic Liquid Storage Vessels (Including Petroleum Liquid Storage Vessels) for Which Construction, Reconstruction, or Modification Commenced after July 23, 1984  
Applicability and designation of affected facility.**

The two hexene storage tanks are subject to the requirements of 40 CFR Part 60 Subpart Kb – Standards of Performance for Volatile Organic Liquid Storage Vessels (Including Petroleum Liquid Storage Vessels) for Which Construction, Reconstruction, or Modification Commenced After July 23, 1984.

**# 008 [40 CFR Part 60 Standards of Performance for New Stationary Sources §40 CFR 60.111b]  
Subpart Kb - Standards of Performance for Volatile Organic Liquid Storage Vessels (Including Petroleum Liquid Storage Vessels) for Which Construction, Reconstruction, or Modification Commenced after July 23, 1984  
Definitions.**

All terms used in 40 CFR Part 60 Subpart Kb shall have the meaning given in 40 CFR §60.111b or else in the Clean Air Act and 40 CFR Part 60 Subpart A.

**SECTION D. Source Level Plan Approval Requirements**

Source ID: 405

Source Name: STORAGE TANKS (MISC PRESSURIZED)

Source Capacity/Throughput:

Conditions for this source occur in the following groups: G11

**I. RESTRICTIONS.**

No additional requirements exist except as provided in other sections of this plan approval including Section B (Plan Approval General Requirements) and/or Section E (Source Group Restrictions).

**II. TESTING REQUIREMENTS.**

No additional testing requirements exist except as provided in other sections of this plan approval including Section B (Plan Approval General Requirements) and/or Section E (Source Group Restrictions).

**III. MONITORING REQUIREMENTS.**

No additional monitoring requirements exist except as provided in other sections of this plan approval including Section B (Plan Approval General Requirements) and/or Section E (Source Group Restrictions).

**IV. RECORDKEEPING REQUIREMENTS.**

No additional record keeping requirements exist except as provided in other sections of this plan approval including Section B (Plan Approval General Requirements) and/or Section E (Source Group Restrictions).

**V. REPORTING REQUIREMENTS.**

No additional reporting requirements exist except as provided in other sections of this plan approval including Section B (Plan Approval General Requirements) and/or Section E (Source Group Restrictions).

**VI. WORK PRACTICE REQUIREMENTS.****# 001 [25 Pa. Code §127.12b]****Plan approval terms and conditions.**

Ethylene, C3+, C3+ refrigerant, butene, isopentane, isobutane, aqueous ammonia, and dimethyl disulfide shall be stored in pressurized and/or refrigerated storage tanks with no uncontrolled vent directed to the atmosphere.

**# 002 [25 Pa. Code §127.12b]****Plan approval terms and conditions.**

Emergency relief vents for pressurized or refrigerated storage tanks shall vent to the HP System.

**VII. ADDITIONAL REQUIREMENTS.**

No additional requirements exist except as provided in other sections of this plan approval including Section B (Plan Approval General Requirements) and/or Section E (Source Group Restrictions).

**SECTION D. Source Level Plan Approval Requirements**

Source ID: 406

Source Name: STORAGE TANKS (DIESEL FUEL &gt; 150 GALLONS)

Source Capacity/Throughput:

Conditions for this source occur in the following groups: G11

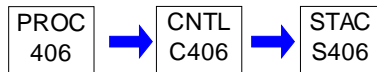
**I. RESTRICTIONS.****Control Device Efficiency Restriction(s).**

# 001 [25 Pa. Code §127.12b]

**Plan approval terms and conditions.**

Diesel fuel storage tank vents shall be controlled by carbon canisters designed to reduce VOC emissions by a minimum of 95%.

**II. TESTING REQUIREMENTS.**

No additional testing requirements exist except as provided in other sections of this plan approval including Section B (Plan Approval General Requirements) and/or Section E (Source Group Restrictions).

**III. MONITORING REQUIREMENTS.**

# 002 [25 Pa. Code §127.12b]

**Plan approval terms and conditions.**

The Owner/Operator shall monitor carbon canisters in accordance with the manufacturer's recommendations to ensure that the adsorption media is regenerated or replaced prior to breakthrough. Breakthrough shall be defined as a VOC reading above background for a single canister and greater than or equal to 50 ppmv for all canisters operated as part of a primary and secondary system.

**IV. RECORDKEEPING REQUIREMENTS.**

No additional record keeping requirements exist except as provided in other sections of this plan approval including Section B (Plan Approval General Requirements) and/or Section E (Source Group Restrictions).

**V. REPORTING REQUIREMENTS.**

No additional reporting requirements exist except as provided in other sections of this plan approval including Section B (Plan Approval General Requirements) and/or Section E (Source Group Restrictions).

**VI. WORK PRACTICE REQUIREMENTS.**

No additional work practice requirements exist except as provided in other sections of this plan approval including Section B (Plan Approval General Requirements) and/or Section E (Source Group Restrictions).

**VII. ADDITIONAL REQUIREMENTS.**

No additional requirements exist except as provided in other sections of this plan approval including Section B (Plan Approval General Requirements) and/or Section E (Source Group Restrictions).

**SECTION D. Source Level Plan Approval Requirements**

Source ID: 407

Source Name: STORAGE TANKS (PYROLYSIS FUEL OIL)

Source Capacity/Throughput:

Conditions for this source occur in the following groups: G11

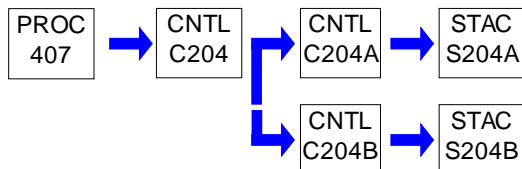
**I. RESTRICTIONS.**

No additional requirements exist except as provided in other sections of this plan approval including Section B (Plan Approval General Requirements) and/or Section E (Source Group Restrictions).

**II. TESTING REQUIREMENTS.**

**# 001 [40 CFR Part 60 Standards of Performance for New Stationary Sources §40 CFR 60.113b]**

**Subpart Kb - Standards of Performance for Volatile Organic Liquid Storage Vessels (Including Petroleum Liquid Storage Vessels) for Which Construction, Reconstruction, or Modification Commenced after July 23, 1984**

**Testing and procedures.**

The Owner/Operator shall comply with the applicable storage tank testing and procedures specified in 40 CFR §60.113b(c) or (d).

**III. MONITORING REQUIREMENTS.**

**# 002 [40 CFR Part 60 Standards of Performance for New Stationary Sources §40 CFR 60.116b]**

**Subpart Kb - Standards of Performance for Volatile Organic Liquid Storage Vessels (Including Petroleum Liquid Storage Vessels) for Which Construction, Reconstruction, or Modification Commenced after July 23, 1984**

**Monitoring of operations.**

The Owner/Operator shall comply with the applicable storage tank monitoring requirements specified in 40 CFR §60.116b.

**IV. RECORDKEEPING REQUIREMENTS.**

No additional record keeping requirements exist except as provided in other sections of this plan approval including Section B (Plan Approval General Requirements) and/or Section E (Source Group Restrictions).

**V. REPORTING REQUIREMENTS.**

**# 003 [40 CFR Part 60 Standards of Performance for New Stationary Sources §40 CFR 60.115b]**

**Subpart Kb - Standards of Performance for Volatile Organic Liquid Storage Vessels (Including Petroleum Liquid Storage Vessels) for Which Construction, Reconstruction, or Modification Commenced after July 23, 1984**

**Reporting and recordkeeping requirements.**

The Owner/Operator shall comply with the applicable storage tank reporting and recordkeeping requirements specified in 40 CFR §60.115b(c) or (d).

**VI. WORK PRACTICE REQUIREMENTS.**

**# 004 [25 Pa. Code §127.12b]**

**Plan approval terms and conditions.**

Pyrolysis fuel oil storage tanks shall be controlled by vapor recovery routed to the LP System.

**# 005 [40 CFR Part 60 Standards of Performance for New Stationary Sources §40 CFR 60.112b]**

**Subpart Kb - Standards of Performance for Volatile Organic Liquid Storage Vessels (Including Petroleum Liquid Storage Vessels) for Which Construction, Reconstruction, or Modification Commenced after July 23, 1984**

**Standard for volatile organic compounds (VOC).**

**SECTION D. Source Level Plan Approval Requirements**

The Owner/Operator shall comply with the applicable storage tank VOC standards specified in 40 CFR §60.112b(a).

**VII. ADDITIONAL REQUIREMENTS.**

**# 006 [40 CFR Part 60 Standards of Performance for New Stationary Sources §40 CFR 60.110b]  
Subpart Kb - Standards of Performance for Volatile Organic Liquid Storage Vessels (Including Petroleum Liquid Storage Vessels) for Which Construction, Reconstruction, or Modification Commenced after July 23, 1984**

**Applicability and designation of affected facility.**

The two pyrolysis fuel oil storage tanks are subject to the requirements of 40 CFR Part 60 Subpart Kb – Standards of Performance for Volatile Organic Liquid Storage Vessels (Including Petroleum Liquid Storage Vessels) for Which Construction, Reconstruction, or Modification Commenced After July 23, 1984.

**# 007 [40 CFR Part 60 Standards of Performance for New Stationary Sources §40 CFR 60.111b]  
Subpart Kb - Standards of Performance for Volatile Organic Liquid Storage Vessels (Including Petroleum Liquid Storage Vessels) for Which Construction, Reconstruction, or Modification Commenced after July 23, 1984**

**Definitions.**

All terms used in 40 CFR Part 60 Subpart Kb shall have the meaning given in 40 CFR §60.111b or else in the Clean Air Act and 40 CFR Part 60 Subpart A.

**SECTION D. Source Level Plan Approval Requirements**

Source ID: 501

Source Name: EQUIPMENT COMPONENTS

Source Capacity/Throughput:

Conditions for this source occur in the following groups: G04  
G05  
G09  
G12

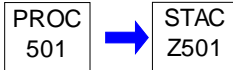
**I. RESTRICTIONS.****Control Device Efficiency Restriction(s).**

**# 001 [40 CFR Part 61 NESHAPs §40 CFR 61.242-11]**  
**Subpart V--National Emission Standard for Equipment Leaks (Fugitive Emission Sources)**  
**Standards: Closed-vent systems and control devices.**

The Owner/Operator shall comply with the applicable standards for closed-vent systems and control devices specified in 40 CFR §61.242-11.

**II. TESTING REQUIREMENTS.**

**# 002 [40 CFR Part 61 NESHAPs §40 CFR 61.245]**  
**Subpart V--National Emission Standard for Equipment Leaks (Fugitive Emission Sources)**  
**Test methods and procedures.**

The Owner/Operator shall comply with the applicable test methods and procedures specified in 40 CFR §61.245.

**III. MONITORING REQUIREMENTS.**

No additional monitoring requirements exist except as provided in other sections of this plan approval including Section B (Plan Approval General Requirements) and/or Section E (Source Group Restrictions).

**IV. RECORDKEEPING REQUIREMENTS.**

**# 003 [40 CFR Part 61 NESHAPs §40 CFR 61.246]**  
**Subpart V--National Emission Standard for Equipment Leaks (Fugitive Emission Sources)**  
**Recordkeeping requirements.**

The Owner/Operator shall comply with the applicable recordkeeping requirements specified in 40 CFR §61.246.

**V. REPORTING REQUIREMENTS.**

**# 004 [40 CFR Part 61 NESHAPs §40 CFR 61.247]**  
**Subpart V--National Emission Standard for Equipment Leaks (Fugitive Emission Sources)**  
**Reporting requirements.**

The Owner/Operator shall comply with the applicable notification and reporting requirements specified in 40 CFR §61.247.

**VI. WORK PRACTICE REQUIREMENTS.**

**# 005 [40 CFR Part 61 NESHAPs §40 CFR 61.112]**  
**Subpart J--National Emission Standard for Equipment Leaks (Fugitive Emission Sources) of Benzene Standards.**

The Owner/Operator shall comply with the applicable standards specified in 40 CFR §61.112.

**# 006 [40 CFR Part 61 NESHAPs §40 CFR 61.242-1]**  
**Subpart V--National Emission Standard for Equipment Leaks (Fugitive Emission Sources)**  
**Standards: General.**

**SECTION D. Source Level Plan Approval Requirements**

The Owner/Operator shall comply with the applicable general standards specified in 40 CFR §61.242-1.

**# 007 [40 CFR Part 61 NESHAPs §40 CFR 61.242-10]**

**Subpart V--National Emission Standard for Equipment Leaks (Fugitive Emission Sources)**

**Standards: Delay of repair.**

The Owner/Operator shall comply with the applicable standards for delay of repair specified in 40 CFR §61.242-10.

**# 008 [40 CFR Part 61 NESHAPs §40 CFR 61.242-2]**

**Subpart V--National Emission Standard for Equipment Leaks (Fugitive Emission Sources)**

**Standards: Pumps.**

The Owner/Operator shall comply with the applicable standards for pumps specified in 40 CFR §61.242-2.

**# 009 [40 CFR Part 61 NESHAPs §40 CFR 61.242-3]**

**Subpart V--National Emission Standard for Equipment Leaks (Fugitive Emission Sources)**

**Standards: Compressors.**

The Owner/Operator shall comply with the applicable standards for compressors specified in 40 CFR §61.242-3.

**# 010 [40 CFR Part 61 NESHAPs §40 CFR 61.242-4]**

**Subpart V--National Emission Standard for Equipment Leaks (Fugitive Emission Sources)**

**Standards: Pressure relief devices in gas/vapor service.**

The Owner/Operator shall comply with the applicable standards for pressure relief devices in gas/vapor service specified in 40 CFR §61.242-4.

**# 011 [40 CFR Part 61 NESHAPs §40 CFR 61.242-5]**

**Subpart V--National Emission Standard for Equipment Leaks (Fugitive Emission Sources)**

**Standards: Sampling connecting systems.**

The Owner/Operator shall comply with the applicable standards for sampling connection systems specified in 40 CFR §61.242-5.

**# 012 [40 CFR Part 61 NESHAPs §40 CFR 61.242-6]**

**Subpart V--National Emission Standard for Equipment Leaks (Fugitive Emission Sources)**

**Standards: Open-ended valves or lines.**

The Owner/Operator shall comply with the applicable standards for open-ended valves or lines specified in 40 CFR §61.242-6.

**# 013 [40 CFR Part 61 NESHAPs §40 CFR 61.242-7]**

**Subpart V--National Emission Standard for Equipment Leaks (Fugitive Emission Sources)**

**Standards: Valves.**

The Owner/Operator shall comply with the applicable standards for valves specified in 40 CFR §61.242-7.

**# 014 [40 CFR Part 61 NESHAPs §40 CFR 61.242-8]**

**Subpart V--National Emission Standard for Equipment Leaks (Fugitive Emission Sources)**

**Standards: Pressure relief devices in liquid service and flanges and other connectors.**

The Owner/Operator shall comply with the applicable standards for pressure relief devices in liquid service and connectors specified in 40 CFR §61.242-8.

**# 015 [40 CFR Part 61 NESHAPs §40 CFR 61.242-9]**

**Subpart V--National Emission Standard for Equipment Leaks (Fugitive Emission Sources)**

**Standards: Product accumulator vessels.**

The Owner/Operator shall comply with the applicable standards for surge control vessels and bottoms receivers specified in 40 CFR §61.242-9.

**SECTION D. Source Level Plan Approval Requirements****VII. ADDITIONAL REQUIREMENTS.****# 016 [40 CFR Part 61 NESHAPs §40 CFR 61.110]****Subpart J--National Emission Standard for Equipment Leaks (Fugitive Emission Sources) of Benzene****Applicability and designation of sources.**

Equipment in benzene service is subject to the requirements of 40 CFR Part 61 Subpart J - National Emission Standard for Equipment Leaks (Fugitive Emission Sources) of Benzene.

**# 017 [40 CFR Part 61 NESHAPs §40 CFR 61.111]****Subpart J--National Emission Standard for Equipment Leaks (Fugitive Emission Sources) of Benzene****Definitions.**

All terms used in 40 CFR Part 61 Subpart J shall have the meaning given in 40 CFR §61.111 or else in the Clean Air Act and 40 CFR Part 61 Subparts A and V.

**# 018 [40 CFR Part 61 NESHAPs §40 CFR 61.240]****Subpart V--National Emission Standard for Equipment Leaks (Fugitive Emission Sources)****Applicability and designation of sources.**

Equipment in benzene service is subject to the requirements of 40 CFR Part 61 Subpart V - National Emission Standard for Equipment Leaks (Fugitive Emission Sources).

**# 019 [40 CFR Part 61 NESHAPs §40 CFR 61.241]****Subpart V--National Emission Standard for Equipment Leaks (Fugitive Emission Sources)****Definitions.**

All terms used in 40 CFR Part 61 Subpart V shall have the meaning given in 40 CFR §61.241 or else in the Clean Air Act, 40 CFR Part 61 Subpart A, or other specific subparts of Part 61.

**# 020 [40 CFR Part 61 NESHAPs §40 CFR 61.244]****Subpart V--National Emission Standard for Equipment Leaks (Fugitive Emission Sources)****Alternative means of emission limitation.**

The Owner/Operator may apply to the Administrator for permission to use an alternative means of emission limitation as specified in 40 CFR §61.244.

**SECTION D. Source Level Plan Approval Requirements**

Source ID: 502

Source Name: WASTEWATER TREATMENT PLANT (SECONDARY &amp; TERTIARY TREATMENT)

Source Capacity/Throughput:

Conditions for this source occur in the following groups: G05

G06

G07

G09

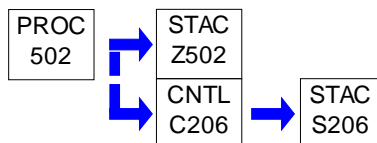
**I. RESTRICTIONS.**

No additional requirements exist except as provided in other sections of this plan approval including Section B (Plan Approval General Requirements) and/or Section E (Source Group Restrictions).

**II. TESTING REQUIREMENTS.**

No additional testing requirements exist except as provided in other sections of this plan approval including Section B (Plan Approval General Requirements) and/or Section E (Source Group Restrictions).

**III. MONITORING REQUIREMENTS.**

No additional monitoring requirements exist except as provided in other sections of this plan approval including Section B (Plan Approval General Requirements) and/or Section E (Source Group Restrictions).

**IV. RECORDKEEPING REQUIREMENTS.**

No additional record keeping requirements exist except as provided in other sections of this plan approval including Section B (Plan Approval General Requirements) and/or Section E (Source Group Restrictions).

**V. REPORTING REQUIREMENTS.**

No additional reporting requirements exist except as provided in other sections of this plan approval including Section B (Plan Approval General Requirements) and/or Section E (Source Group Restrictions).

**VI. WORK PRACTICE REQUIREMENTS.**

No additional work practice requirements exist except as provided in other sections of this plan approval including Section B (Plan Approval General Requirements) and/or Section E (Source Group Restrictions).

**VII. ADDITIONAL REQUIREMENTS.**

No additional requirements exist except as provided in other sections of this plan approval including Section B (Plan Approval General Requirements) and/or Section E (Source Group Restrictions).

**SECTION D. Source Level Plan Approval Requirements**

Source ID: 503

Source Name: PLANT ROADWAYS

Source Capacity/Throughput:

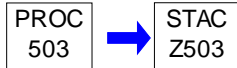
**I. RESTRICTIONS.**

No additional requirements exist except as provided in other sections of this plan approval including Section B (Plan Approval General Requirements).

**II. TESTING REQUIREMENTS.**

No additional testing requirements exist except as provided in other sections of this plan approval including Section B (Plan Approval General Requirements).

**III. MONITORING REQUIREMENTS.**

No additional monitoring requirements exist except as provided in other sections of this plan approval including Section B (Plan Approval General Requirements).

**IV. RECORDKEEPING REQUIREMENTS.**

No additional record keeping requirements exist except as provided in other sections of this plan approval including Section B (Plan Approval General Requirements).

**V. REPORTING REQUIREMENTS.**

No additional reporting requirements exist except as provided in other sections of this plan approval including Section B (Plan Approval General Requirements).

**VI. WORK PRACTICE REQUIREMENTS.****# 001 [25 Pa. Code §127.12b]****Plan approval terms and conditions.**

In-plant roadways shall be paved and maintained so as to prevent fugitive emissions.

**# 002 [25 Pa. Code §127.12b]****Plan approval terms and conditions.**

The Owner/Operator shall develop and implement a roadway dust control plan to prevent fugitive emissions. Dust control shall include roadway watering, sweeping, and application of winterized surfactant as necessary during colder months.

**VII. ADDITIONAL REQUIREMENTS.**

No additional requirements exist except as provided in other sections of this plan approval including Section B (Plan Approval General Requirements).

**SECTION E. Source Group Plan Approval Restrictions.**

Group Name: G01

Group Description: Ethane Cracking Furnaces

Sources included in this group

ID	Name
031	ETHANE CRACKING FURNACE #1
032	ETHANE CRACKING FURNACE #2
033	ETHANE CRACKING FURNACE #3
034	ETHANE CRACKING FURNACE #4
035	ETHANE CRACKING FURNACE #5
036	ETHANE CRACKING FURNACE #6
037	ETHANE CRACKING FURNACE #7

**I. RESTRICTIONS.****Emission Restriction(s).****# 001 [25 Pa. Code §127.12b]****Plan approval terms and conditions.**

GHG emissions from the ethane cracking furnaces shall not exceed 1,048,670 tons of CO<sub>2</sub>e from all furnaces combined in any consecutive 12-month period. Compliance with this limit may be determined through CO<sub>2</sub>e calculations in accordance with 40 CFR §98.34(b)(3) or utilizing an in-line gas chromatograph.

**# 002 [25 Pa. Code §127.12b]****Plan approval terms and conditions.**

Visible emissions from each of the ethane cracking furnace stacks shall not exceed the following:

- Equal to or greater than 10% opacity for a period or periods aggregating more than 3 minutes in any one hour.
- Equal to or greater than 30% opacity at any time.

**# 003 [25 Pa. Code §127.12b]****Plan approval terms and conditions.**

VOC emissions from each of the ethane cracking furnaces shall not exceed 1.18 lb/hr.

**# 004 [25 Pa. Code §127.12b]****Plan approval terms and conditions.**

CO emissions from the ethane cracking furnaces shall not exceed the following:

- 0.035 lb/MMBtu from each furnace on a monthly 12-month rolling average; excluding periods of startup, shutdown, and decoking.
- 52.2 lb/hr from each furnace during periods of startup, shutdown, and decoking.
- 670.4 tons from all furnaces combined in any consecutive 12-month period.

**# 005 [25 Pa. Code §127.12b]****Plan approval terms and conditions.**

PM<sub>10</sub> and PM<sub>2.5</sub> emissions from each of the ethane cracking furnaces shall not exceed the following:

- 3.10 lb/hr, excluding periods of decoking.
- 1.86 lb/hr during periods of decoking.
- 12.4 tons in any consecutive 12-month period.

**# 006 [25 Pa. Code §127.12b]****Plan approval terms and conditions.**

NH<sub>3</sub> emissions from each of the ethane cracking furnaces shall not exceed 10 ppmvd at 3% O<sub>2</sub>.

**SECTION E. Source Group Plan Approval Restrictions.****# 007 [25 Pa. Code §127.12b]****Plan approval terms and conditions.**

NOx emissions from the ethane cracking furnaces shall not exceed the following:

- 0.01 lb/MMBtu from each furnace on a monthly 12-month rolling average, excluding periods of defined non-normal operating modes.
- 0.015 lb/MMBtu from each furnace on a 1-hour average, excluding periods of defined non-normal operating modes.
- 9.30 lb/hr from each furnace during periods of decoking, hot steam standby, feed in, or feed out.
- 31.1 lb/hr from each furnace during periods of startup or shutdown.
- 181.3 tons from all furnaces combined in any consecutive 12-month period.

**Operation Hours Restriction(s).****# 008 [25 Pa. Code §127.12b]****Plan approval terms and conditions.**

The Owner/Operator may only operate an ethane cracking furnace in a defined operating mode. Operating modes of the ethane cracking furnaces are defined as follows:

- Startup – Beginning when fuel is introduced to the furnace and ending when the SCR catalyst bed reaches its design operating temperature.
- Hot Steam Standby – When the furnace is firing at or below 50% of the maximum allowable firing rate and no hydrocarbon feed is being charged to the furnace, and not operating in startup or shutdown mode.
- Feed In – Beginning when hydrocarbon feed is introduced to the furnace and ending when the furnace reaches 70% of the maximum allowable firing rate.
- Normal – When the furnace is firing at or above 70% of the maximum allowable firing rate with hydrocarbon feed being charged to the furnace.
- Feed Out – Beginning when the furnace drops below 70% of its maximum allowable firing rate and ending when hydrocarbon feed is isolated from the furnace.
- Shutdown – Beginning when the SCR catalyst bed drops below its design operating temperature and ending upon removing all fuel from the furnace.
- Decoking – Beginning when air is introduced to the furnace for the purpose of decoking and ending when decoking air is removed.

**# 009 [25 Pa. Code §127.12b]****Plan approval terms and conditions.**

Only one ethane cracking furnace may be operating in decoking mode at any time, and no more than two furnaces may be operating in a defined non-normal operating mode at any time, except in cases where a furnace must be taken offline for unscheduled maintenance.

**II. TESTING REQUIREMENTS.****# 010 [25 Pa. Code §127.12b]****Plan approval terms and conditions.**

The Owner/Operator shall perform VOC, PM10, PM2.5, and NH3 emission testing upon each of the seven ethane cracking furnaces while operating in normal operating mode and according to the requirements of 25 Pa. Code Chapter 139. Initial performance testing is required within 180 days of startup of the furnaces or on an alternative schedule as approved by the Department. Subsequent performance testing is required at minimum of once every 5 years thereafter. Extension to the initial and subsequent performance testing deadlines may be granted by the Department in writing in response to a written request from the Owner/Operator and upon a satisfactory showing that an extension is justified. EPA Reference Method performance testing shall be conducted for the initial and subsequent performance tests.

**# 011 [25 Pa. Code §127.12b]****Plan approval terms and conditions.**

The Owner/Operator shall perform PM10 and PM2.5 emission testing upon each of the seven ethane cracking furnaces while operating in decoking mode and according to the requirements of 25 Pa. Code Chapter 139. Initial performance testing is required during the first decoking cycle after startup of the furnaces or on an alternative schedule as approved by the Department. Testing shall be performed as early as practicable after commencement of the decoking cycle.

**SECTION E. Source Group Plan Approval Restrictions.**

Subsequent performance testing is required at minimum of once every 5 years thereafter. Extension to the initial and subsequent performance testing deadlines may be granted by the Department in writing in response to a written request from the Owner/Operator and upon a satisfactory showing that an extension is justified. EPA Reference Method performance testing shall be conducted for the initial and subsequent performance tests.

**III. MONITORING REQUIREMENTS.****# 012 [25 Pa. Code §123.51]****Monitoring requirements**

The Owner/Operator shall install and operate NO<sub>x</sub> continuous monitoring systems to monitor NO<sub>x</sub> emissions from each ethane cracking furnace in accordance with 25 Pa. Code §123.51.

**# 013 [25 Pa. Code §127.12b]****Plan approval terms and conditions.**

The Owner/Operator shall monitor for ammonia slip from each ethane cracking furnace in accordance with any one of the following methods:

a. Mass balance. Ammonia emissions are calculated as the difference between the input ammonia, measured by the ammonia injection rate, and the ammonia reacted, measured by the differential NO<sub>x</sub> upstream and downstream of the control device that injects urea or ammonia into the exhaust stream. The ammonia emissions must be calculated using the following equation:

$$\text{NH}_3 @ 3\% \text{ O}_2 = [(a/b * 10^6) - c] * d$$

Where:

a = ammonia injection rate (in pounds per hour (lb/hr))/17 pound per pound-mole (lb/lb-mol);

b = dry exhaust flow rate (lb/hr)/29 lb/lb-mol;

c = change in measured NO<sub>x</sub> concentration across catalyst (ppmv at reference oxygen); and

d = correction factor, the ratio of measured slip to calculated ammonia slip, where the measured slip is obtained from the stack testing for ammonia during the initial demonstration of compliance required by this Plan Approval.

b. Oxidation of ammonia to nitric oxide (NO). Convert ammonia to NO using a molybdenum oxidizer and measure ammonia slip by difference using a NO analyzer. The NO analyzer must be quality assured in accordance with the manufacturer's specifications and with a quarterly cylinder gas audit with a 10 ppmv reference sample of ammonia passed through the probe and confirming monitor response to within ± 2.0 ppmv for the furnaces.

c. Stain tubes. Measure ammonia using a sorbent or stain tube device specific for ammonia measurement in the 5.0 to 10.0 ppmv range for the furnaces. Every effort must be made to sample near the normal highest ammonia injection rate.

d. Other methods as approved by the Department.

Ammonia slip monitoring shall be conducted at a minimum of once each day for each source for the first 60 days of operation. Monitoring may subsequently be reduced to a minimum of once each week for each source if operating procedures have been developed to prevent excess amounts of ammonia from being introduced in the control device and when operation of the control device has been proven successful with regard to controlling ammonia slip. Daily monitoring must resume when the catalyst is within 30 days of its useful life expectancy.

**# 014 [25 Pa. Code §127.12b]****Plan approval terms and conditions.**

The Owner/Operator shall continuously monitor and record the catalyst bed inlet and outlet temperature for each SCR system.

**# 015 [25 Pa. Code §127.12b]****Plan approval terms and conditions.**

The Owner/Operator shall install and operate CO continuous monitoring systems to monitor CO emissions from each ethane cracking furnace. The following sub-requirements shall be met and in compliance with 25 Pa. Code Chapter 139, Subchapter C:

**SECTION E. Source Group Plan Approval Restrictions.**

- a. Other monitoring systems shall be installed and operated to convert data to required reporting units.
- b. Results shall be submitted on a regular schedule and in a format acceptable to the Department.
- c. Installed monitors shall meet the minimum data availability requirements.

**IV. RECORDKEEPING REQUIREMENTS.**

No additional record keeping requirements exist except as provided in other sections of this plan approval including Section B (Plan Approval General Requirements).

**V. REPORTING REQUIREMENTS.**

No additional reporting requirements exist except as provided in other sections of this plan approval including Section B (Plan Approval General Requirements).

**VI. WORK PRACTICE REQUIREMENTS.****# 016 [25 Pa. Code §127.12b]****Plan approval terms and conditions.**

The Owner/Operator shall perform a tune-up of each ethane cracking furnace at a minimum of once every 5 years as follows:

- a) Inspect the burner, as applicable, and clean or replace any components of the burner as necessary (the burner inspection may be delayed until the next scheduled unit shutdown). At units where entry into a piece of process equipment or into a storage vessel is required to complete the tune-up inspections, inspections are required only during planned entries into the storage vessel or process equipment;
- b) Inspect the flame pattern, as applicable, and adjust the burner as necessary to optimize the flame pattern. The adjustment should be consistent with the manufacturer's specifications, if available;
- c) Inspect the system controlling the air-to-fuel ratio, as applicable, and ensure that it is correctly calibrated and functioning properly;
- d) Optimize total emissions of CO. This optimization should be consistent with the manufacturer's specifications, if available, and with any NOx requirement to which the unit is subject;
- e) Record the concentrations in the effluent stream of CO in parts per million, by volume, and oxygen in volume percent, before and after the adjustments are made. Concentrations may be taken from CEM data; and
- f) Maintain on-site and submit, if requested by the Department, a report containing the following information:
  - 1) The concentrations of CO in the effluent stream in parts per million by volume, and oxygen in volume percent, measured at high fire or typical operating load, before and after the tune-up of the boiler or process heater; and
  - 2) A description of any corrective actions taken as a part of the tune-up.

**# 017 [25 Pa. Code §127.12b]****Plan approval terms and conditions.**

Exhaust gas temperature from each of the ethane cracking furnace stacks shall not exceed 350°F on a monthly 12-month rolling average; excluding periods of startup, shutdown, hot steam standby, or decoking.

**# 018 [25 Pa. Code §127.12b]****Plan approval terms and conditions.**

Exhaust gas generated from each of the ethane cracking furnaces while operating in decoking mode shall be directed through a separator and back into the furnace firebox to ensure complete combustion.

**VII. ADDITIONAL REQUIREMENTS.**

No additional requirements exist except as provided in other sections of this plan approval including Section B (Plan Approval General Requirements).

**SECTION E. Source Group Plan Approval Restrictions.**

Group Name: G02

Group Description: Cogeneration Units

Sources included in this group

ID	Name
101	COMBUSTION TURBINE/DUCT BURNER UNIT #1
102	COMBUSTION TURBINE/DUCT BURNER UNIT #2
103	COMBUSTION TURBINE/DUCT BURNER UNIT #3

**I. RESTRICTIONS.****Emission Restriction(s).****# 001 [25 Pa. Code §127.12b]****Plan approval terms and conditions.**

NOx emissions from the combustion turbines with duct burners shall not exceed the following:

- 2 ppmvd @ 15% O<sub>2</sub> from each turbine/duct burner on a 1-hour average, excluding periods of defined startup or shutdown.
- 113 lb/hr from each turbine/duct burner during periods of startup or shutdown.
- 65.4 tons from all turbines and duct burners combined in any consecutive 12-month period.

For purposes of determining compliance with these NOx limits, startup is defined as beginning when fuel is introduced into the turbine and ending when the SCR catalyst bed reaches its design operating temperature.

For purposes of determining compliance with these NOx limits, shutdown is defined as beginning when the SCR catalyst bed drops below its design operating temperature and ending upon removing all fuel from the turbine.

**# 002 [25 Pa. Code §127.12b]****Plan approval terms and conditions.**

VOC emissions from each of the combustion turbines with duct burners shall not exceed the following:

- 1 ppmvd @ 15% O<sub>2</sub> on a 1-hour average.

**# 003 [25 Pa. Code §127.12b]****Plan approval terms and conditions.**

CO emissions from the combustion turbines with duct burners shall not exceed the following:

- 2 ppmvd @ 15% O<sub>2</sub> from each turbine/duct burner on a 1-hour average, excluding periods of defined startup or shutdown.
- 276 lb/hr from each turbine/duct burner during periods of startup or shutdown.
- 42.0 tons from all turbines and duct burners combined in any consecutive 12-month period.

For purposes of determining compliance with these CO limits, startup is defined as beginning upon commencement of ignition and ending when the combustion turbine reaches 55% of its baseload operating level.

For purposes of determining compliance with these CO limits, shutdown is defined as beginning when the combustion turbine drops below 55% of its baseload operating level and ending when fuel is cut to this unit. Each shutdown event shall not exceed 30 minutes in duration.

**# 004 [25 Pa. Code §127.12b]****Plan approval terms and conditions.**

PM<sub>10</sub> and PM<sub>2.5</sub> emissions from each of the combustion turbines with duct burners shall not exceed the following:

- 0.0066 lb/MMBtu.

**# 005 [25 Pa. Code §127.12b]****Plan approval terms and conditions.**

GHG emissions from the combustion turbines with duct burners shall not exceed the following:

**SECTION E. Source Group Plan Approval Restrictions.**

- 1,030 lbs CO<sub>2</sub>e/MWh from all turbines and duct burners combined on a daily 30-day rolling average.
- 340,558 tons of CO<sub>2</sub>e in any consecutive 12-month period.

Compliance with these limits may be determined through CO<sub>2</sub> calculations in accordance with 40 CFR Part 75 Appendix G and multiplied by a factor of 1.0010.

**# 006 [25 Pa. Code §127.12b]****Plan approval terms and conditions.**

NH<sub>3</sub> emissions from each of the combustion turbines with duct burners shall not exceed 5 ppmvd at 15% O<sub>2</sub>.

**# 007 [25 Pa. Code §127.12b]****Plan approval terms and conditions.**

Visible emissions from each of the combustion turbines and duct burners stack shall not exceed 10% opacity at any time.

**# 008 [25 Pa. Code §127.12b]****Plan approval terms and conditions.**

HCHO emissions from each of the combustion turbines with duct burners shall not exceed 91 ppbvd @ 15% O<sub>2</sub>.

**# 009 [40 CFR Part 60 Standards of Performance for New Stationary Sources §40 CFR 60.4320]****Subpart KKKK - Standards of Performance for Stationary Combustion Turbines****What emission limits must I meet for nitrogen oxides (NOX)?**

The Owner/Operator shall comply with the applicable NO<sub>x</sub> limits specified in 40 CFR §60.4320. [Compliance with the LAER NO<sub>x</sub> limit of 2 ppmvd @ 15% O<sub>2</sub> will show compliance with this requirement.]

**# 010 [40 CFR Part 60 Standards of Performance for New Stationary Sources §40 CFR 60.4330]****Subpart KKKK - Standards of Performance for Stationary Combustion Turbines****What emission limits must I meet for sulfur dioxide (SO<sub>2</sub>)?**

The Owner/Operator shall comply with the applicable SO<sub>2</sub> limits specified in 40 CFR §60.4330. [Compliance with the natural gas fuel sulfur limit of 0.5 grains/100 dscf will show compliance with this requirement.]

**II. TESTING REQUIREMENTS.****# 011 [25 Pa. Code §127.12b]****Plan approval terms and conditions.**

The Owner/Operator shall perform VOC, PM<sub>10</sub>, PM<sub>2.5</sub>, HCHO, and NH<sub>3</sub> emission testing upon each of the three combustion turbines with duct burners according to the requirements of 25 Pa. Code Chapter 139. Initial performance testing is required within 180 days of startup of the turbines or on an alternative schedule as approved by the Department. Subsequent performance testing is required at minimum of once every 5 years thereafter. Extension to the initial and subsequent performance testing deadlines may be granted by the Department in writing in response to a written request from the Owner/Operator and upon a satisfactory showing that an extension is justified. EPA Reference Method performance testing shall be conducted for the initial and subsequent performance tests.

**# 012 [40 CFR Part 60 Standards of Performance for New Stationary Sources §40 CFR 60.4400]****Subpart KKKK - Standards of Performance for Stationary Combustion Turbines****How do I conduct the initial and subsequent performance tests, regarding NOX ?**

The Owner/Operator shall comply with the applicable NO<sub>x</sub> performance testing requirements specified in 40 CFR §60.4400.

**# 013 [40 CFR Part 60 Standards of Performance for New Stationary Sources §40 CFR 60.4405]****Subpart KKKK - Standards of Performance for Stationary Combustion Turbines****How do I perform the initial performance test if I have chosen to install a NOX-diluent CEMS?**

The Owner/Operator shall comply with the applicable initial NO<sub>x</sub> performance test specified in 40 CFR §60.4405.

**# 014 [40 CFR Part 60 Standards of Performance for New Stationary Sources §40 CFR 60.4415]****Subpart KKKK - Standards of Performance for Stationary Combustion Turbines****How do I conduct the initial and subsequent performance tests for sulfur?**

The Owner/Operator shall comply with the applicable sulfur performance testing requirements specified in 40 CFR §60.4415.

**SECTION E. Source Group Plan Approval Restrictions.****III. MONITORING REQUIREMENTS.****# 015 [25 Pa. Code §123.51]****Monitoring requirements**

The Owner/Operator shall install and operate NOx continuous monitoring systems to monitor NOx emissions from each combustion turbine in accordance with 25 Pa. Code §123.51.

**# 016 [25 Pa. Code §127.12b]****Plan approval terms and conditions.**

The Owner/Operator shall install and operate CO continuous monitoring systems to monitor CO emissions from each combustion turbine. The following sub-requirements shall be met and in compliance with 25 Pa. Code Chapter 139, Subchapter C:

- a. Other monitoring systems shall be installed and operated to convert data to required reporting units.
- b. Results shall be submitted on a regular schedule and in a format acceptable to the Department.
- c. Installed monitors shall meet the minimum data availability requirements.

**# 017 [25 Pa. Code §127.12b]****Plan approval terms and conditions.**

The Owner/Operator shall continuously monitor and record the catalyst bed inlet temperature for each SCR system.

**# 018 [25 Pa. Code §127.12b]****Plan approval terms and conditions.**

The Owner/Operator shall monitor for ammonia slip from each combustion turbine in accordance with any one of the following methods:

- a. Mass balance. Ammonia emissions are calculated as the difference between the input ammonia, measured by the ammonia injection rate, and the ammonia reacted, measured by the differential NOx upstream and downstream of the control device that injects urea or ammonia into the exhaust stream. The ammonia emissions must be calculated using the following equation:

$$\text{NH}_3 @ 15\% \text{ O}_2 = [(a/b * 106) - c] * d$$

Where:

a = ammonia injection rate (in pounds per hour (lb/hr))/17 pound per pound-mole (lb/lb-mol);

b = dry exhaust flow rate (lb/hr)/29 lb/lb-mol;

c = change in measured NOx concentration across catalyst (ppmv at reference oxygen); and

d = correction factor, the ratio of measured slip to calculated ammonia slip, where the measured slip is obtained from the stack testing for ammonia during the initial demonstration of compliance required by this Plan Approval.

- b. Oxidation of ammonia to nitric oxide (NO). Convert ammonia to NO using a molybdenum oxidizer and measure ammonia slip by difference using a NO analyzer. The NO analyzer must be quality assured in accordance with the manufacturer's specifications and with a quarterly cylinder gas audit with a 5 ppmv reference sample of ammonia passed through the probe and confirming monitor response to within  $\pm 1.0$  ppmv for the turbines.

- c. Stain tubes. Measure ammonia using a sorbent or stain tube device specific for ammonia measurement in the 1.0 to 5.0 ppmv range for the turbines. Every effort must be made to sample near the normal highest ammonia injection rate.

- d. Other methods as approved by the Department.

Ammonia slip monitoring shall be conducted at a minimum of once each day for each source for the first 60 days of operation. Monitoring may subsequently be reduced to a minimum of once each week for each source if operating procedures have been developed to prevent excess amounts of ammonia from being introduced in the control device and when operation of the control device has been proven successful with regard to controlling ammonia slip. Daily monitoring must resume when the catalyst is within 30 days of its useful life expectancy.

**# 019 [40 CFR Part 60 Standards of Performance for New Stationary Sources §40 CFR 60.4340]****Subpart KKKK - Standards of Performance for Stationary Combustion Turbines****How do I demonstrate continuous compliance for NOX if I do not use water or steam injection?**

**SECTION E. Source Group Plan Approval Restrictions.**

The Owner/Operator shall comply with the applicable NOx continuous compliance demonstration requirements specified in 40 CFR §60.4340.

**# 020 [40 CFR Part 60 Standards of Performance for New Stationary Sources §40 CFR 60.4345]****Subpart KKKK - Standards of Performance for Stationary Combustion Turbines****What are the requirements for the continuous emission monitoring system equipment, if I choose to use this option?**

The Owner/Operator shall comply with the applicable NOx CEMS requirements specified in 40 CFR §60.4345.

**# 021 [40 CFR Part 60 Standards of Performance for New Stationary Sources §40 CFR 60.4350]****Subpart KKKK - Standards of Performance for Stationary Combustion Turbines****How do I use data from the continuous emission monitoring equipment to identify excess emissions?**

The Owner/Operator shall comply with the applicable continuous monitoring data excess emissions requirements specified in 40 CFR §60.4350.

**# 022 [40 CFR Part 60 Standards of Performance for New Stationary Sources §40 CFR 60.4360]****Subpart KKKK - Standards of Performance for Stationary Combustion Turbines****How do I determine the total sulfur content of the turbine's combustion fuel?**

The Owner/Operator shall comply with the applicable fuel sulfur content determination requirements specified in 40 CFR §60.4360.

**# 023 [40 CFR Part 60 Standards of Performance for New Stationary Sources §40 CFR 60.4365]****Subpart KKKK - Standards of Performance for Stationary Combustion Turbines****How can I be exempted from monitoring the total sulfur content of the fuel?**

The Owner/Operator shall comply with the applicable fuel sulfur monitoring exemption requirements specified in 40 CFR §60.4365.

**# 024 [40 CFR Part 60 Standards of Performance for New Stationary Sources §40 CFR 60.4380]****Subpart KKKK - Standards of Performance for Stationary Combustion Turbines****How are excess emissions and monitor downtime defined for NOX ?**

The Owner/Operator shall comply with the applicable NOx excess emissions and monitor downtime requirements specified in 40 CFR §60.4380.

**IV. RECORDKEEPING REQUIREMENTS.****# 025 [25 Pa. Code §127.12b]****Plan approval terms and conditions.**

The Owner/Operator shall maintain records of the hourly 4-hour rolling average of each combustion turbine's oxidation catalyst inlet temperature.

**V. REPORTING REQUIREMENTS.****# 026 [25 Pa. Code §127.12b]****Plan approval terms and conditions.**

The Owner/Operator of lean premix stationary combustion turbines is only required to comply with the initial notification requirements of 40 CFR Part 63 Subpart YYYY as specified in 40 CFR §63.6095.

**# 027 [25 Pa. Code §127.12b]****Plan approval terms and conditions.**

The Owner/Operator shall comply with the applicable initial notification requirements of 40 CFR Part 63 Subpart YYYY as specified in 40 CFR §63.6145(c).

**# 028 [40 CFR Part 60 Standards of Performance for New Stationary Sources §40 CFR 60.4375]****Subpart KKKK - Standards of Performance for Stationary Combustion Turbines****What reports must I submit?**

The Owner/Operator shall comply with the applicable reporting requirements specified in 40 CFR §60.4375.

**# 029 [40 CFR Part 60 Standards of Performance for New Stationary Sources §40 CFR 60.4395]****Subpart KKKK - Standards of Performance for Stationary Combustion Turbines****When must I submit my reports?**

The Owner/Operator shall comply with the applicable reporting deadlines specified in 40 CFR §60.4395.

**SECTION E. Source Group Plan Approval Restrictions.****VI. WORK PRACTICE REQUIREMENTS.****# 030 [25 Pa. Code §127.12b]****Plan approval terms and conditions.**

The Owner/Operator shall continuously monitor and maintain the 4-hour rolling average of each combustion turbine's oxidation catalyst inlet temperature within its designed operating temperature range.

**VII. ADDITIONAL REQUIREMENTS.****# 031 [25 Pa. Code §127.12b]****Plan approval terms and conditions.**

The three combustion turbines are subject to limited requirements of 40 CFR Part 63 Subpart YYYY – National Emissions Standards for Hazardous Air Pollutants for Stationary Combustion Turbines.

**# 032 [25 Pa. Code §127.12b]****Plan approval terms and conditions.**

All terms used in 40 CFR Part 63 Subpart YYYY shall have the meaning given in 40 CFR §63.6175 or else in the Clean Air Act and 40 CFR Part 63 Subpart A.

**# 033 [25 Pa. Code §127.12b]****Plan approval terms and conditions.**

The Owner/Operator shall comply with the applicable requirements of 40 CFR Part 97 Subpart AAAAA – TR NO<sub>x</sub> Annual Trading Program for each of the three combustion turbines with heat recovery steam generators and duct burners.

**# 034 [25 Pa. Code §127.12b]****Plan approval terms and conditions.**

The Owner/Operator shall comply with the applicable requirements of 40 CFR Part 97 Subpart BBBBB – TR NO<sub>x</sub> Ozone Season Trading Program for each of the three combustion turbines with heat recovery steam generators and duct burners.

**# 035 [25 Pa. Code §127.12b]****Plan approval terms and conditions.**

The Owner/Operator shall comply with the applicable requirements of 40 CFR Part 97 Subpart CCCCC – TR SO<sub>2</sub> Group 1 Trading Program for each of the three combustion turbines with heat recovery steam generators and duct burners.

**# 036 [40 CFR Part 60 Standards of Performance for New Stationary Sources §40 CFR 60.4305]****Subpart KKKK - Standards of Performance for Stationary Combustion Turbines****Does this subpart apply to my stationary combustion turbine?**

The three combustion turbines with heat recovery steam generators and duct burners are subject to the requirements of 40 CFR Part 60 Subpart KKKK – Standards of Performance for Stationary Combustion Turbines.

**# 037 [40 CFR Part 60 Standards of Performance for New Stationary Sources §40 CFR 60.4333]****Subpart KKKK - Standards of Performance for Stationary Combustion Turbines****What are my general requirements for complying with this subpart?**

The Owner/Operator shall comply with the applicable general requirements specified in 40 CFR §60.4333.

**# 038 [40 CFR Part 60 Standards of Performance for New Stationary Sources §40 CFR 60.4420]****Subpart KKKK - Standards of Performance for Stationary Combustion Turbines****What definitions apply to this subpart?**

All terms used in 40 CFR Part 60 Subpart KKKK shall have the meaning given in 40 CFR §60.4420 or else in the Clean Air Act and 40 CFR Part 60 Subpart A.

**# 039 [40 CFR Part 72 Regulations on Permits §40 CFR 72.6]****Subpart A--Acid Rain Program General Provisions****Applicability.**

The three combustion turbines with heat recovery steam generators and duct burners are classified as Utility units and subject to the requirements of the Acid Rain Program as specified in 40 CFR §72.6(a).

**# 040 [40 CFR Part 72 Regulations on Permits §40 CFR 72.9]****Subpart A--Acid Rain Program General Provisions****Standard requirements.**

The Owner/Operator shall comply with the applicable permit requirements, including the requirement to submit a complete Acid Rain permit application (at least 24 months before the date on which the unit commences operation), as specified in 40 CFR §72.9(a).

**SECTION E. Source Group Plan Approval Restrictions.**

Group Name: G03

Group Description: Emergency Generator/Fire Pump Engines

Sources included in this group

ID	Name
105	DIESEL-FIRED EMERGENCY GENERATOR ENGINES (2)
106	FIRE PUMP ENGINES (2)

**I. RESTRICTIONS.****Emission Restriction(s).****# 001 [25 Pa. Code §127.12b]****Plan approval terms and conditions.**

Visible emissions from each diesel-fired emergency generator engine shall not exceed the following:

- Equal to or greater than 10% for a period or periods aggregating more than three (3) minutes in any one (1) hour;
- Greater than 20% during the acceleration mode;
- Greater than 15% during the lugging mode; and
- Equal to or greater than 30% at any time.

**# 002 [25 Pa. Code §127.12b]****Plan approval terms and conditions.**

Visible emissions from each diesel-fired fire pump engine shall not exceed the following:

- Equal to or greater than 10% for a period or periods aggregating more than three (3) minutes in any one (1) hour; and
- Equal to or greater than 30% at any time.

**# 003 [25 Pa. Code §127.12b]****Plan approval terms and conditions.**Each diesel-fired emergency generator engine shall be certified to meet the following NMHC + NO<sub>x</sub> emission standard, and CO and PM Tier 2 Emission Standards derived from Table 1 to Subpart B of Part 89:

- 4.6 g/bhp-hr of NMHC + NO<sub>x</sub>
- 2.6 g/bhp-hr of CO
- 0.15 g/bhp-hr of PM

**# 004 [40 CFR Part 60 Standards of Performance for New Stationary Sources §40 CFR 60.4205]****Subpart III - Standards of Performance for Stationary Compression Ignition Internal Combustion Engines****What emission standards must I meet for emergency engines if I am an owner or operator of a stationary CI internal combustion engine?**

Each diesel-fired fire pump engine shall be certified to meet the following Emission Standards for Stationary Fire Pump Engines in Table 4 to Subpart III of Part 60:

- 3.0 g/bhp-hr of NMHC + NO<sub>x</sub>
- 2.6 g/bhp-hr of CO
- 0.15 g/bhp-hr of PM

**Fuel Restriction(s).****# 005 [40 CFR Part 60 Standards of Performance for New Stationary Sources §40 CFR 60.4207]****Subpart III - Standards of Performance for Stationary Compression Ignition Internal Combustion Engines****What fuel requirements must I meet if I am an owner or operator of a stationary CI internal combustion engine subject to this subpart?**

Beginning October 1, 2010, owners and operators of stationary CI ICE subject to this subpart with a displacement of less than 30 liters per cylinder that use diesel fuel must purchase diesel fuel that meets the requirements of 40 CFR 80.510(b) for nonroad diesel fuel.

**# 006 [40 CFR Part 60 Standards of Performance for New Stationary Sources §40 CFR 60.4207]****Subpart III - Standards of Performance for Stationary Compression Ignition Internal Combustion Engines****What fuel requirements must I meet if I am an owner or operator of a stationary CI internal combustion engine subject to this subpart?**

**SECTION E. Source Group Plan Approval Restrictions.**

Beginning June 1, 2010. Except as otherwise specifically provided in [40 CFR Part 80 Subpart I], all NR and [N/A] diesel fuel is subject to the following per-gallon standards:

- 1) Sulfur content:
  - i. 15 ppm maximum for NR diesel fuel.
  - ii. N/A
- 2) Cetane index or aromatic content, as follows:
  - i. A minimum cetane index of 40; or
  - ii. A maximum aromatic content of 35 volume percent.

**II. TESTING REQUIREMENTS.**

No additional testing requirements exist except as provided in other sections of this plan approval including Section B (Plan Approval General Requirements).

**III. MONITORING REQUIREMENTS.**

**# 007 [40 CFR Part 60 Standards of Performance for New Stationary Sources §40 CFR 60.4209]  
Subpart IIII - Standards of Performance for Stationary Compression Ignition Internal Combustion Engines  
What are the monitoring requirements if I am an owner or operator of a stationary CI internal combustion engine?**

The Owner/Operator shall install non-resettable hour meters as specified in 40 CFR §60.4209(a).

**IV. RECORDKEEPING REQUIREMENTS.**

**# 008 [40 CFR Part 60 Standards of Performance for New Stationary Sources §40 CFR 60.4214]  
Subpart IIII - Standards of Performance for Stationary Compression Ignition Internal Combustion Engines  
What are my notification, reporting, and recordkeeping requirements if I am an owner or operator of a stationary CI internal combustion engine?**

The Owner/Operator shall comply with the applicable recordkeeping requirements specified in 40 CFR §60.4214(b).

**V. REPORTING REQUIREMENTS.**

**# 009 [40 CFR Part 63 NESHAPS for Source Categories §40 CFR 63.6645]  
Subpart ZZZZ - National Emissions Standards for Hazardous Air Pollutants for Stationary Reciprocating Internal Combustion Engines  
What notifications must I submit and when?**

The Owner/Operator shall comply with the applicable initial notification requirements specified in 40 CFR §63.6645(f).

**VI. WORK PRACTICE REQUIREMENTS.**

**# 010 [40 CFR Part 60 Standards of Performance for New Stationary Sources §40 CFR 60.4206]  
Subpart IIII - Standards of Performance for Stationary Compression Ignition Internal Combustion Engines  
How long must I meet the emission standards if I am an owner or operator of a stationary CI internal combustion engine?**

Owners and operators of stationary CI ICE must operate and maintain stationary CI ICE that achieve the emission standards as required in §§60.4204 and 60.4205 over the entire life of the engine.

**# 011 [40 CFR Part 60 Standards of Performance for New Stationary Sources §40 CFR 60.4211]  
Subpart IIII - Standards of Performance for Stationary Compression Ignition Internal Combustion Engines  
What are my compliance requirements if I am an owner or operator of a stationary CI internal combustion engine?**

The Owner/Operator shall meet the applicable compliance requirements specified in 40 CFR §60.4211(a), (c), and (f).

**VII. ADDITIONAL REQUIREMENTS.**

**# 012 [40 CFR Part 60 Standards of Performance for New Stationary Sources §40 CFR 60.4200]  
Subpart IIII - Standards of Performance for Stationary Compression Ignition Internal Combustion Engines  
Am I subject to this subpart?**

The four diesel-fired emergency generator engines and three diesel-fired fire pump engines are subject to the requirements of 40 CFR Part 60 Subpart IIII - Standards of Performance for Stationary Compression Ignition Internal Combustion Engines.

**SECTION E. Source Group Plan Approval Restrictions.****# 013 [40 CFR Part 60 Standards of Performance for New Stationary Sources §40 CFR 60.4218]****Subpart IIII - Standards of Performance for Stationary Compression Ignition Internal Combustion Engines****What parts of the General Provisions apply to me?**

The Owner/Operator shall comply with the applicable General Provisions in §§60.1 through 60.19 listed in Table 8 to 40 CFR Part 60 Subpart IIII as specified in 40 CFR §60.4218.

**# 014 [40 CFR Part 60 Standards of Performance for New Stationary Sources §40 CFR 60.4219]****Subpart IIII - Standards of Performance for Stationary Compression Ignition Internal Combustion Engines****What definitions apply to this subpart?**

All terms used in 40 CFR Part 60 Subpart IIII shall have the meaning given in 40 CFR §60.4219 or else in the Clean Air Act and 40 CFR Part 60 Subpart A.

**# 015 [40 CFR Part 63 NESHAPS for Source Categories §40 CFR 63.6585]****Subpart ZZZZ - National Emissions Standards for Hazardous Air Pollutants for Stationary Reciprocating Internal Combustion Engines****Am I subject to this subpart?**

The four diesel-fired emergency generator engines and three diesel-fired fire pump engines are subject to limited requirements of 40 CFR Part 63 Subpart ZZZZ – National Emissions Standards for Hazardous Air Pollutants for Stationary Reciprocating Internal Combustion Engines.

**# 016 [40 CFR Part 63 NESHAPS for Source Categories §40 CFR 63.6590]****Subpart ZZZZ - National Emissions Standards for Hazardous Air Pollutants for Stationary Reciprocating Internal Combustion Engines****What parts of my plant does this subpart cover?**

The Owner/Operator shall comply with the criteria for limited requirements as specified in 40 CFR §63.6590(b)(1)(i).

**# 017 [40 CFR Part 63 NESHAPS for Source Categories §40 CFR 63.6675]****Subpart ZZZZ - National Emissions Standards for Hazardous Air Pollutants for Stationary Reciprocating Internal Combustion Engines****What definitions apply to this subpart?**

All terms used in 40 CFR Part 63 Subpart ZZZZ shall have the meaning given in 40 CFR §63.6675 or else in the Clean Air Act and 40 CFR Part 63 Subpart A.

**SECTION E. Source Group Plan Approval Restrictions.**

Group Name: G04

Group Description: NESHAP Part 63 Subpart UU

Sources included in this group

ID	Name
201	ETHYLENE MANUFACTURING LINE
501	EQUIPMENT COMPONENTS

**I. RESTRICTIONS.****Control Device Efficiency Restriction(s).****# 001 [40 CFR Part 63 NESHAPS for Source Categories §40 CFR 63.1034]****Subpart UU - National Emission Standards for Equipment Leaks - Control Level 2 Standards****Closed vent systems and control devices; or emissions routed to a fuel gas system or process standards.**

The Owner/Operator shall comply with the applicable standards for ethylene manufacturing line closed vent systems and control devices; or emissions routed to a fuel gas system or process specified in 40 CFR §63.1034.

**II. TESTING REQUIREMENTS.**

No additional testing requirements exist except as provided in other sections of this plan approval including Section B (Plan Approval General Requirements).

**III. MONITORING REQUIREMENTS.****# 002 [40 CFR Part 63 NESHAPS for Source Categories §40 CFR 63.1023]****Subpart UU - National Emission Standards for Equipment Leaks - Control Level 2 Standards****Instrument and sensory monitoring for leaks.**

The Owner/Operator shall comply with the applicable ethylene manufacturing line instrument and sensory monitoring requirements applicable to equipment leaks as specified in 40 CFR §63.1023.

**IV. RECORDKEEPING REQUIREMENTS.****# 003 [40 CFR Part 63 NESHAPS for Source Categories §40 CFR 63.1022]****Subpart UU - National Emission Standards for Equipment Leaks - Control Level 2 Standards****Equipment identification.**

The Owner/Operator shall comply with the applicable ethylene manufacturing line affected equipment identification and designation requirements specified in 40 CFR §63.1022.

**# 004 [40 CFR Part 63 NESHAPS for Source Categories §40 CFR 63.1038]****Subpart UU - National Emission Standards for Equipment Leaks - Control Level 2 Standards****Recordkeeping requirements.**

The Owner/Operator shall comply with the applicable recordkeeping requirements for ethylene manufacturing line equipment leaks specified in 40 CFR §63.1038.

**V. REPORTING REQUIREMENTS.****# 005 [40 CFR Part 63 NESHAPS for Source Categories §40 CFR 63.1039]****Subpart UU - National Emission Standards for Equipment Leaks - Control Level 2 Standards****Reporting requirements.**

The Owner/Operator shall comply with the applicable reporting requirements for ethylene manufacturing line equipment leaks specified in 40 CFR §63.1039.

**VI. WORK PRACTICE REQUIREMENTS.****# 006 [40 CFR Part 63 NESHAPS for Source Categories §40 CFR 63.1024]****Subpart UU - National Emission Standards for Equipment Leaks - Control Level 2 Standards****Leak repair.**

The Owner/Operator shall comply with the applicable ethylene manufacturing line equipment leak repair requirements specified in 40 CFR §63.1024.

**SECTION E. Source Group Plan Approval Restrictions.****# 007 [40 CFR Part 63 NESHAPS for Source Categories §40 CFR 63.1025]****Subpart UU - National Emission Standards for Equipment Leaks - Control Level 2 Standards  
Valves in gas and vapor service and in light liquid service standards.**

The Owner/Operator shall comply with the applicable standards for ethylene manufacturing line valves in gas/vapor service and light liquid service specified in 40 CFR §63.1025.

**# 008 [40 CFR Part 63 NESHAPS for Source Categories §40 CFR 63.1026]****Subpart UU - National Emission Standards for Equipment Leaks - Control Level 2 Standards  
Pumps in light liquid service standards.**

The Owner/Operator shall comply with the applicable standards for ethylene manufacturing line pumps in light liquid service specified in 40 CFR §63.1026.

**# 009 [40 CFR Part 63 NESHAPS for Source Categories §40 CFR 63.1027]****Subpart UU - National Emission Standards for Equipment Leaks - Control Level 2 Standards  
Connectors in gas and vapor service and in light liquid service standards.**

The Owner/Operator shall comply with the applicable standards for ethylene manufacturing line connectors in gas/vapor service and light liquid service specified in 40 CFR §63.1027.

**# 010 [40 CFR Part 63 NESHAPS for Source Categories §40 CFR 63.1028]****Subpart UU - National Emission Standards for Equipment Leaks - Control Level 2 Standards  
Agitators in gas and vapor service and in light liquid service standards.**

The Owner/Operator shall comply with the applicable standards for ethylene manufacturing line agitators in gas/vapor service and light liquid service specified in 40 CFR §63.1028.

**# 011 [40 CFR Part 63 NESHAPS for Source Categories §40 CFR 63.1029]****Subpart UU - National Emission Standards for Equipment Leaks - Control Level 2 Standards  
Pumps, valves, connectors, and agitators in heavy liquid service; pressure relief devices in liquid service; and instrumentation systems standards.**

The Owner/Operator shall comply with the applicable standards for ethylene manufacturing line pumps, valves, connectors, and agitators in heavy liquid service; pressure relief devices in liquid service; and instrumentation systems specified in 40 CFR §63.1029.

**# 012 [40 CFR Part 63 NESHAPS for Source Categories §40 CFR 63.1030]****Subpart UU - National Emission Standards for Equipment Leaks - Control Level 2 Standards  
Pressure relief devices in gas and vapor service standards.**

The Owner/Operator shall comply with the applicable standards for ethylene manufacturing line pressure relief devices in gas/vapor service specified in 40 CFR §63.1030.

**# 013 [40 CFR Part 63 NESHAPS for Source Categories §40 CFR 63.1031]****Subpart UU - National Emission Standards for Equipment Leaks - Control Level 2 Standards  
Compressors standards.**

The Owner/Operator shall comply with the applicable standards for ethylene manufacturing line compressors specified in 40 CFR §63.1031.

**# 014 [40 CFR Part 63 NESHAPS for Source Categories §40 CFR 63.1032]****Subpart UU - National Emission Standards for Equipment Leaks - Control Level 2 Standards  
Sampling connection systems standards.**

The Owner/Operator shall comply with the applicable standards for ethylene manufacturing line sampling connection systems specified in 40 CFR §63.1032.

**# 015 [40 CFR Part 63 NESHAPS for Source Categories §40 CFR 63.1033]****Subpart UU - National Emission Standards for Equipment Leaks - Control Level 2 Standards  
Open-ended valves or lines standards.**

The Owner/Operator shall comply with the applicable standards for ethylene manufacturing line open-ended valves or lines specified in 40 CFR §63.1033.

**# 016 [40 CFR Part 63 NESHAPS for Source Categories §40 CFR 63.1035]****Subpart UU - National Emission Standards for Equipment Leaks - Control Level 2 Standards  
Quality improvement program for pumps.**

The Owner/Operator shall comply with the quality improvement program for ethylene manufacturing line pumps specified in

**SECTION E. Source Group Plan Approval Restrictions.**

40 CFR §63.1035.

**VII. ADDITIONAL REQUIREMENTS.****# 017 [40 CFR Part 63 NESHAPS for Source Categories §40 CFR 63.1019]****Subpart UU - National Emission Standards for Equipment Leaks - Control Level 2 Standards****Applicability.**

Ethylene manufacturing line equipment containing or contacting greater than or equal to 5 wt% organic HAP (and not in vacuum service) is subject to the requirements of 40 CFR Part 63 Subpart UU – National Emission Standards for Equipment Leaks – Control Level 2 Standards.

**# 018 [40 CFR Part 63 NESHAPS for Source Categories §40 CFR 63.1020]****Subpart UU - National Emission Standards for Equipment Leaks - Control Level 2 Standards****Definitions.**

All terms used in 40 CFR Part 63 Subpart UU shall have the meaning given in 40 CFR §63.1020 or else in the Clean Air Act.

**SECTION E. Source Group Plan Approval Restrictions.**

Group Name: G05

Group Description: NESHAP Part 63 Subpart YY

Sources included in this group

ID	Name
201	ETHYLENE MANUFACTURING LINE
203	PROCESS COOLING TOWER
302	LIQUID LOADOUT (RECOVERED OIL)
303	LIQUID LOADOUT (PYROLYSIS FO, LT GASOLINE, PE3 HEAVIES)
304	LIQUID LOADOUT (C3+, BUTENE, ISOPENTANE, ISOBUTANE, C3 REF)
305	LIQUID LOADOUT (BLENDED PITCH)
402	STORAGE TANK (SPENT CAUSTIC)
403	STORAGE TANKS (LIGHT GASOLINE)
501	EQUIPMENT COMPONENTS
502	WASTEWATER TREATMENT PLANT (SECONDARY & TERTIARY TREATMENT)

**I. RESTRICTIONS.****Control Device Efficiency Restriction(s).****# 001 [40 CFR Part 63 NESHAPS for Source Categories §40 CFR 63.1103]****Subpart YY - National Emission Standards for Hazardous Air Pollutants for Source Categories: Generic Maximum Achievable Control Technology Standards****Source category-specific applicability, definitions, and requirements.**

The Owner/Operator shall reduce emissions of total organic HAP from the light gasoline and pyrolysis fuel oil storage tanks by [a minimum of] 98 wt% by venting emissions through a closed vent system to any combination of control devices and meet the requirements of §63.982(a)(1) as specified in Table 7(b)(1)(ii) to 40 CFR §63.1103(e). [Compliance with the LAER VOC control requirements to install an IFR and capture and route vapors to the LP System will show compliance with this requirement]

**# 002 [40 CFR Part 63 NESHAPS for Source Categories §40 CFR 63.1103]****Subpart YY - National Emission Standards for Hazardous Air Pollutants for Source Categories: Generic Maximum Achievable Control Technology Standards****Source category-specific applicability, definitions, and requirements.**

The Owner/Operator shall comply with the applicable requirements for ethylene process vents as specified in Table 7(d)(1) to 40 CFR §63.1103(e).

**# 003 [40 CFR Part 63 NESHAPS for Source Categories §40 CFR 63.1103]****Subpart YY - National Emission Standards for Hazardous Air Pollutants for Source Categories: Generic Maximum Achievable Control Technology Standards****Source category-specific applicability, definitions, and requirements.**

The Owner/Operator shall comply with the applicable requirements for transfer racks as specified in Table 7(e)(1) to 40 CFR §63.1103(e).

**II. TESTING REQUIREMENTS.****# 004 [40 CFR Part 63 NESHAPS for Source Categories §40 CFR 63.1104]****Subpart YY - National Emission Standards for Hazardous Air Pollutants for Source Categories: Generic Maximum Achievable Control Technology Standards****Process vents from continuous unit operations: applicability assessment procedures and methods.**

The Owner/Operator shall comply with the applicable applicability assessment procedures and methods for process vents from continuous unit operations specified in 40 CFR §63.1104.

**# 005 [40 CFR Part 63 NESHAPS for Source Categories §40 CFR 63.1107]****Subpart YY - National Emission Standards for Hazardous Air Pollutants for Source Categories: Generic Maximum Achievable Control Technology Standards****Equipment leaks: applicability assessment procedures and methods.**

**SECTION E. Source Group Plan Approval Restrictions.**

The Owner/Operator shall comply with the applicable applicability assessment procedures and methods for equipment leaks specified in 40 CFR §63.1107.

**III. MONITORING REQUIREMENTS.**

**# 006 [40 CFR Part 63 NESHAPS for Source Categories §40 CFR 63.1108]**

**Subpart YY - National Emission Standards for Hazardous Air Pollutants for Source Categories: Generic Maximum Achievable Control Technology Standards**

**Compliance with standards and operation and maintenance requirements.**

The Owner/Operator shall comply with the applicable compliance assessment procedures for ethylene production specified in 40 CFR §63.1108(b).

**IV. RECORDKEEPING REQUIREMENTS.**

**# 007 [40 CFR Part 63 NESHAPS for Source Categories §40 CFR 63.1109]**

**Subpart YY - National Emission Standards for Hazardous Air Pollutants for Source Categories: Generic Maximum Achievable Control Technology Standards**

**Recordkeeping requirements.**

The Owner/Operator shall comply with the applicable recordkeeping requirements for ethylene production specified in 40 CFR §63.1109.

**V. REPORTING REQUIREMENTS.**

**# 008 [40 CFR Part 63 NESHAPS for Source Categories §40 CFR 63.1110]**

**Subpart YY - National Emission Standards for Hazardous Air Pollutants for Source Categories: Generic Maximum Achievable Control Technology Standards**

**Reporting requirements.**

The Owner/Operator shall comply with the applicable reporting requirements for ethylene production specified in 40 CFR §63.1110.

**VI. WORK PRACTICE REQUIREMENTS.**

**# 009 [40 CFR Part 63 NESHAPS for Source Categories §40 CFR 63.1105]**

**Subpart YY - National Emission Standards for Hazardous Air Pollutants for Source Categories: Generic Maximum Achievable Control Technology Standards**

**Transfer racks.**

The Owner/Operator shall comply with the applicable requirements for transfer racks as specified in 40 CFR §63.1105.

**# 010 [40 CFR Part 63 NESHAPS for Source Categories §40 CFR 63.1108]**

**Subpart YY - National Emission Standards for Hazardous Air Pollutants for Source Categories: Generic Maximum Achievable Control Technology Standards**

**Compliance with standards and operation and maintenance requirements.**

The Owner/Operator shall comply with the applicable compliance with standards and operation and maintenance requirements for ethylene production specified in 40 CFR §63.1108(a)(1), (2), and (5) through (7).

**VII. ADDITIONAL REQUIREMENTS.**

**# 011 [40 CFR Part 63 NESHAPS for Source Categories §40 CFR 63.1100]**

**Subpart YY - National Emission Standards for Hazardous Air Pollutants for Source Categories: Generic Maximum Achievable Control Technology Standards**

**Applicability.**

The Owner/Operator shall comply with the applicable General Provisions in §§63.1 through 63.5, and §§63.12 through 63.15 as specified in 40 CFR §63.1100(b).

**# 012 [40 CFR Part 63 NESHAPS for Source Categories §40 CFR 63.1101]**

**Subpart YY - National Emission Standards for Hazardous Air Pollutants for Source Categories: Generic Maximum Achievable Control Technology Standards**

**Definitions.**

All terms used in 40 CFR Part 63 Subpart YY shall have the meaning given in 40 CFR §63.1101 or else in the Clean Air Act or §63.2 (General Provisions).

**SECTION E. Source Group Plan Approval Restrictions.****# 013 [40 CFR Part 63 NESHAPS for Source Categories §40 CFR 63.1103]****Subpart YY - National Emission Standards for Hazardous Air Pollutants for Source Categories: Generic Maximum Achievable Control Technology Standards****Source category-specific applicability, definitions, and requirements.**

The ethylene manufacturing line affected storage vessels, process vents, transfer racks, equipment, waste streams, heat exchange systems, and cracking furnaces and associated decoking operations are subject to the requirements of 40 CFR Part 63 Subpart YY – National Emission Standards for Hazardous Air Pollutants for Source Categories: Generic Maximum Achievable Control Technology Standards.

**# 014 [40 CFR Part 63 NESHAPS for Source Categories §40 CFR 63.1103]****Subpart YY - National Emission Standards for Hazardous Air Pollutants for Source Categories: Generic Maximum Achievable Control Technology Standards****Source category-specific applicability, definitions, and requirements.**

The Owner/Operator shall comply with the applicable requirements for storage vessels containing organic HAP as specified in Table 7(b)(1) to 40 CFR §63.1103(e).

**# 015 [40 CFR Part 63 NESHAPS for Source Categories §40 CFR 63.1103]****Subpart YY - National Emission Standards for Hazardous Air Pollutants for Source Categories: Generic Maximum Achievable Control Technology Standards****Source category-specific applicability, definitions, and requirements.**

The Owner/Operator shall comply with the applicable requirements for equipment containing or contacting organic HAP as specified in Table 7(f)(1) to 40 CFR §63.1103(e).

**# 016 [40 CFR Part 63 NESHAPS for Source Categories §40 CFR 63.1103]****Subpart YY - National Emission Standards for Hazardous Air Pollutants for Source Categories: Generic Maximum Achievable Control Technology Standards****Source category-specific applicability, definitions, and requirements.**

The Owner/Operator shall comply with the applicable requirements for waste streams containing benzene, cumene, ethyl benzene, hexane, naphthalene, styrene, toluene, o-xylene, m-xylene, p-xylene, or 1,3-butadiene as specified in Table 7(g)(1) to 40 CFR §63.1103(e).

**# 017 [40 CFR Part 63 NESHAPS for Source Categories §40 CFR 63.1103]****Subpart YY - National Emission Standards for Hazardous Air Pollutants for Source Categories: Generic Maximum Achievable Control Technology Standards****Source category-specific applicability, definitions, and requirements.**

The Owner/Operator shall comply with the applicable requirements for heat exchange systems as specified in Table 7(h) to 40 CFR §63.1103(e).

**SECTION E. Source Group Plan Approval Restrictions.**

Group Name: G06

Group Description: NESHAP Part 63 Subpart XX

Sources included in this group

ID	Name
201	ETHYLENE MANUFACTURING LINE
203	PROCESS COOLING TOWER
401	STORAGE TANKS (RECOVERED OIL, EQUALIZATION WASTEWATER)
402	STORAGE TANK (SPENT CAUSTIC)
502	WASTEWATER TREATMENT PLANT (SECONDARY & TERTIARY TREATMENT)

**I. RESTRICTIONS.**

No additional requirements exist except as provided in other sections of this plan approval including Section B (Plan Approval General Requirements).

**II. TESTING REQUIREMENTS.**

No additional testing requirements exist except as provided in other sections of this plan approval including Section B (Plan Approval General Requirements).

**III. MONITORING REQUIREMENTS.**

**# 001 [40 CFR Part 63 NESHAPS for Source Categories §40 CFR 63.1086]**

**Subpart XX - National Emission Standards for Ethylene Manufacturing Process Units: Heat Exchange Systems and Waste Operations**

**How must I monitor for leaks to cooling water?**

The Owner/Operator shall comply with the applicable ethylene manufacturing line heat exchange system cooling water leak monitoring requirements specified in 40 CFR §63.1086.

**IV. RECORDKEEPING REQUIREMENTS.**

**# 002 [40 CFR Part 63 NESHAPS for Source Categories §40 CFR 63.1089]**

**Subpart XX - National Emission Standards for Ethylene Manufacturing Process Units: Heat Exchange Systems and Waste Operations**

**What records must I keep?**

The Owner/Operator shall comply with the applicable recordkeeping requirements for ethylene manufacturing line heat exchange systems specified in 40 CFR §63.1089.

**V. REPORTING REQUIREMENTS.**

**# 003 [40 CFR Part 63 NESHAPS for Source Categories §40 CFR 63.1090]**

**Subpart XX - National Emission Standards for Ethylene Manufacturing Process Units: Heat Exchange Systems and Waste Operations**

**What reports must I submit?**

The Owner/Operator shall comply with the applicable reporting requirements for ethylene manufacturing line heat exchange systems specified in 40 CFR §63.1090.

**# 004 [40 CFR Part 63 NESHAPS for Source Categories §40 CFR 63.1096]**

**Subpart XX - National Emission Standards for Ethylene Manufacturing Process Units: Heat Exchange Systems and Waste Operations**

**What requirements must I comply with if I transfer waste off-site?**

The Owner/Operator shall comply with the applicable notice and certification requirements for off-site waste transfer specified in 40 CFR §63.1096.

**VI. WORK PRACTICE REQUIREMENTS.**

**# 005 [40 CFR Part 63 NESHAPS for Source Categories §40 CFR 63.1087]**

**Subpart XX - National Emission Standards for Ethylene Manufacturing Process Units: Heat Exchange Systems and Waste Operations**

**What actions must I take if a leak is detected?**

The Owner/Operator shall comply with the applicable ethylene manufacturing line heat exchange system leak repair

**SECTION E. Source Group Plan Approval Restrictions.**

requirements specified in 40 CFR §63.1087.

**# 006 [40 CFR Part 63 NESHAPS for Source Categories §40 CFR 63.1088]****Subpart XX - National Emission Standards for Ethylene Manufacturing Process Units: Heat Exchange Systems and Waste Operations****In what situations may I delay leak repair, and what actions must I take for delay of repair?**

The Owner/Operator may delay repair of ethylene manufacturing line heat exchange system leaks in accordance with the criteria specified in 40 CFR §63.1088.

**# 007 [40 CFR Part 63 NESHAPS for Source Categories §40 CFR 63.1095]****Subpart XX - National Emission Standards for Ethylene Manufacturing Process Units: Heat Exchange Systems and Waste Operations****What specific requirements must I comply with?**

The Owner/Operator shall comply with the specific requirements applicable to ethylene manufacturing line waste streams containing benzene specified in 40 CFR §63.1095(b).

**VII. ADDITIONAL REQUIREMENTS.****# 008 [40 CFR Part 63 NESHAPS for Source Categories §40 CFR 63.1082]****Subpart XX - National Emission Standards for Ethylene Manufacturing Process Units: Heat Exchange Systems and Waste Operations****What definitions do I need to know?**

All terms used in 40 CFR Part 63 Subpart XX shall have the meaning given in 40 CFR §63.1082 or else in the Clean Air Act, §63.1103(e), or §61.341.

**# 009 [40 CFR Part 63 NESHAPS for Source Categories §40 CFR 63.1083]****Subpart XX - National Emission Standards for Ethylene Manufacturing Process Units: Heat Exchange Systems and Waste Operations****Does this subpart apply to my heat exchange system?**

Ethylene manufacturing line heat exchange systems are subject to the requirements of 40 CFR Part 63 Subpart XX - National Emission Standards for Ethylene Manufacturing Process Units: Heat Exchange Systems and Waste Operations.

**# 010 [40 CFR Part 63 NESHAPS for Source Categories §40 CFR 63.1085]****Subpart XX - National Emission Standards for Ethylene Manufacturing Process Units: Heat Exchange Systems and Waste Operations****What are the general requirements for heat exchange systems?**

The Owner/Operator shall comply with the applicable ethylene manufacturing line heat exchange system general requirements specified in 40 CFR §63.1085.

**# 011 [40 CFR Part 63 NESHAPS for Source Categories §40 CFR 63.1093]****Subpart XX - National Emission Standards for Ethylene Manufacturing Process Units: Heat Exchange Systems and Waste Operations****Does this subpart apply to my waste streams?**

Ethylene manufacturing line waste streams are subject to the requirements of 40 CFR Part 63 Subpart XX - National Emission Standards for Ethylene Manufacturing Process Units: Heat Exchange Systems and Waste Operations.

**# 012 [40 CFR Part 63 NESHAPS for Source Categories §40 CFR 63.1094]****Subpart XX - National Emission Standards for Ethylene Manufacturing Process Units: Heat Exchange Systems and Waste Operations****What waste streams are exempt from the requirements of this subpart?**

The following waste streams are exempt from the requirements of 40 CFR Part 63 Subpart XX:

- a. Waste in the form of gas or vapor emitted from process fluids.
- b. Waste that is contained in a segregated storm water sewer system.

**SECTION E. Source Group Plan Approval Restrictions.**

Group Name: G07

Group Description: NSPS Part 60 Subpart VVa

Sources included in this group

ID	Name
201	ETHYLENE MANUFACTURING LINE
502	WASTEWATER TREATMENT PLANT (SECONDARY & TERTIARY TREATMENT)

**I. RESTRICTIONS.****Control Device Efficiency Restriction(s).****# 001 [40 CFR Part 60 Standards of Performance for New Stationary Sources §40 CFR 60.482-10a]**

**Subpart VVa - Standards of Performance for Equipment Leaks of VOC in the Synthetic Organic Chemicals Manufacturing Industry for Which Construction, Reconstruction, or Modification Commenced After November 7, 2006**  
**Standards: Closed vent systems and control devices.**

The Owner/Operator shall comply with the applicable standards for closed vent systems and control devices specified in 40 CFR §60.482-10a.

**II. TESTING REQUIREMENTS.****# 002 [40 CFR Part 60 Standards of Performance for New Stationary Sources §40 CFR 60.485a]**

**Subpart VVa - Standards of Performance for Equipment Leaks of VOC in the Synthetic Organic Chemicals Manufacturing Industry for Which Construction, Reconstruction, or Modification Commenced After November 7, 2006**  
**Test methods and procedures.**

The Owner/Operator shall comply with the applicable test methods and procedures specified in 40 CFR §60.485a.

**III. MONITORING REQUIREMENTS.**

No additional monitoring requirements exist except as provided in other sections of this plan approval including Section B (Plan Approval General Requirements).

**IV. RECORDKEEPING REQUIREMENTS.****# 003 [40 CFR Part 60 Standards of Performance for New Stationary Sources §40 CFR 60.486a]**

**Subpart VVa - Standards of Performance for Equipment Leaks of VOC in the Synthetic Organic Chemicals Manufacturing Industry for Which Construction, Reconstruction, or Modification Commenced After November 7, 2006**  
**Recordkeeping requirements.**

The Owner/Operator shall comply with the applicable recordkeeping requirements specified in 40 CFR §60.486a.

**V. REPORTING REQUIREMENTS.****# 004 [40 CFR Part 60 Standards of Performance for New Stationary Sources §40 CFR 60.487a]**

**Subpart VVa - Standards of Performance for Equipment Leaks of VOC in the Synthetic Organic Chemicals Manufacturing Industry for Which Construction, Reconstruction, or Modification Commenced After November 7, 2006**  
**Reporting requirements.**

The Owner/Operator shall comply with the applicable reporting requirements specified in 40 CFR §60.487a.

**VI. WORK PRACTICE REQUIREMENTS.****# 005 [40 CFR Part 60 Standards of Performance for New Stationary Sources §40 CFR 60.482-11a]**

**Subpart VVa - Standards of Performance for Equipment Leaks of VOC in the Synthetic Organic Chemicals Manufacturing Industry for Which Construction, Reconstruction, or Modification Commenced After November 7, 2006**  
**Standards: Connectors in gas/vapor service and in light liquid service.**

The Owner/Operator shall comply with the applicable standards for connectors in gas/vapor service and in light liquid service specified in 40 CFR §60.482-11a.

**# 006 [40 CFR Part 60 Standards of Performance for New Stationary Sources §40 CFR 60.482-2a]**

**Subpart VVa - Standards of Performance for Equipment Leaks of VOC in the Synthetic Organic Chemicals Manufacturing Industry for Which Construction, Reconstruction, or Modification Commenced After November 7, 2006**  
**Standards: Pumps in light liquid service.**

The Owner/Operator shall comply with the applicable standards for pumps in light liquid service specified in 40 CFR

**SECTION E. Source Group Plan Approval Restrictions.**

§60.482-2a.

**# 007 [40 CFR Part 60 Standards of Performance for New Stationary Sources §40 CFR 60.482-3a]  
Subpart VVa - Standards of Performance for Equipment Leaks of VOC in the Synthetic Organic Chemicals Manufacturing Industry for Which Construction, Reconstruction, or Modification Commenced After November 7, 2006  
Standards: Compressors.**

The Owner/Operator shall comply with the applicable standards for compressors specified in 40 CFR §60.482-3a.

**# 008 [40 CFR Part 60 Standards of Performance for New Stationary Sources §40 CFR 60.482-4a]  
Subpart VVa - Standards of Performance for Equipment Leaks of VOC in the Synthetic Organic Chemicals Manufacturing Industry for Which Construction, Reconstruction, or Modification Commenced After November 7, 2006  
Standards: Pressure relief devices in gas/vapor service.**

The Owner/Operator shall comply with the applicable standards for pressure relief devices in gas/vapor service specified in 40 CFR §60.482-4a.

**# 009 [40 CFR Part 60 Standards of Performance for New Stationary Sources §40 CFR 60.482-5a]  
Subpart VVa - Standards of Performance for Equipment Leaks of VOC in the Synthetic Organic Chemicals Manufacturing Industry for Which Construction, Reconstruction, or Modification Commenced After November 7, 2006  
Standards: Sampling connection systems.**

The Owner/Operator shall comply with the applicable standards for sampling connection systems specified in 40 CFR §60.482-5a.

**# 010 [40 CFR Part 60 Standards of Performance for New Stationary Sources §40 CFR 60.482-6a]  
Subpart VVa - Standards of Performance for Equipment Leaks of VOC in the Synthetic Organic Chemicals Manufacturing Industry for Which Construction, Reconstruction, or Modification Commenced After November 7, 2006  
Standards: Open-ended valves or lines.**

The Owner/Operator shall comply with the applicable standards for open-ended valves or lines specified in 40 CFR §60.482-6a.

**# 011 [40 CFR Part 60 Standards of Performance for New Stationary Sources §40 CFR 60.482-7a]  
Subpart VVa - Standards of Performance for Equipment Leaks of VOC in the Synthetic Organic Chemicals Manufacturing Industry for Which Construction, Reconstruction, or Modification Commenced After November 7, 2006  
Standards: Valves in gas/vapor service and in light liquid service.**

The Owner/Operator shall comply with the applicable standards for valves in gas/vapor service and in light liquid service specified in 40 CFR §60.482-7a.

**# 012 [40 CFR Part 60 Standards of Performance for New Stationary Sources §40 CFR 60.482-8a]  
Subpart VVa - Standards of Performance for Equipment Leaks of VOC in the Synthetic Organic Chemicals Manufacturing Industry for Which Construction, Reconstruction, or Modification Commenced After November 7, 2006  
Standards: Pumps, valves, and connectors in heavy liquid service and pressure relief devices in light liquid or heavy liquid service.**

The Owner/Operator shall comply with the applicable standards for pumps, valves, and connectors in heavy liquid service and pressure relief devices in light liquid or heavy liquid service specified in 40 CFR §60.482-8a.

**# 013 [40 CFR Part 60 Standards of Performance for New Stationary Sources §40 CFR 60.482-9a]  
Subpart VVa - Standards of Performance for Equipment Leaks of VOC in the Synthetic Organic Chemicals Manufacturing Industry for Which Construction, Reconstruction, or Modification Commenced After November 7, 2006  
Standards: Delay of repair.**

The Owner/Operator shall comply with the applicable standards for delays of repair specified in 40 CFR §60.482-9a.

**VII. ADDITIONAL REQUIREMENTS.**

**# 014 [40 CFR Part 60 Standards of Performance for New Stationary Sources §40 CFR 60.480a]  
Subpart VVa - Standards of Performance for Equipment Leaks of VOC in the Synthetic Organic Chemicals Manufacturing Industry for Which Construction, Reconstruction, or Modification Commenced After November 7, 2006  
Applicability and designation of affected facility.**

The ethylene manufacturing line is subject to the requirements of 40 CFR Part 60 Subpart VVa - Standards of Performance for Equipment Leaks of VOC in the Synthetic Organic Chemicals Manufacturing Industry for Which Construction,

**SECTION E. Source Group Plan Approval Restrictions.**

Reconstruction, or Modification Commenced After November 7, 2006.

**# 015 [40 CFR Part 60 Standards of Performance for New Stationary Sources §40 CFR 60.481a]  
Subpart VVa - Standards of Performance for Equipment Leaks of VOC in the Synthetic Organic Chemicals  
Manufacturing Industry for Which Construction, Reconstruction, or Modification Commenced After November 7, 2006  
Definitions.**

All terms used in 40 CFR Part 60 Subpart VVa shall have the meaning given in 40 CFR §60.481a or else in the Clean Air Act and 40 CFR Part 60 Subpart A.

**# 016 [40 CFR Part 60 Standards of Performance for New Stationary Sources §40 CFR 60.482-1a]  
Subpart VVa - Standards of Performance for Equipment Leaks of VOC in the Synthetic Organic Chemicals  
Manufacturing Industry for Which Construction, Reconstruction, or Modification Commenced After November 7, 2006  
Standards: General.**

The Owner/Operator shall comply with the applicable general standards specified in 40 CFR §60.482-1a.

**# 017 [40 CFR Part 60 Standards of Performance for New Stationary Sources §40 CFR 60.484a]  
Subpart VVa - Standards of Performance for Equipment Leaks of VOC in the Synthetic Organic Chemicals  
Manufacturing Industry for Which Construction, Reconstruction, or Modification Commenced After November 7, 2006  
Equivalence of means of emission limitation.**

The Owner/Operator may apply to the Administrator for a determination of equivalence for any means of emission limitation that achieves a reduction in emissions of VOC at least equivalent to the reduction in emissions of VOC achieved by the controls required in 40 CFR Part 60 Subpart VVa as specified in 40 CFR §60.484a.

**# 018 [40 CFR Part 60 Standards of Performance for New Stationary Sources §40 CFR 60.489a]  
Subpart VVa - Standards of Performance for Equipment Leaks of VOC in the Synthetic Organic Chemicals  
Manufacturing Industry for Which Construction, Reconstruction, or Modification Commenced After November 7, 2006  
List of chemicals produced by affected facilities.**

Chemicals produced by affected facilities under 40 CFR Part 60 Subpart VVa include ethylene and are listed in 40 CFR §60.489 as referenced by 40 CFR §60.489a.

**SECTION E. Source Group Plan Approval Restrictions.**

Group Name: G08

Group Description: NESHAP Part 63 Subpart SS

Sources included in this group

ID	Name
201	ETHYLENE MANUFACTURING LINE
202	POLYETHYLENE MANUFACTURING LINES
204	CVTO HEADER SYSTEM
205	HIGH PRESSURE (HP) HEADER SYSTEM
206	SPENT CAUSTIC VENT HEADER SYSTEM

**I. RESTRICTIONS.**

No additional requirements exist except as provided in other sections of this plan approval including Section B (Plan Approval General Requirements).

**II. TESTING REQUIREMENTS.****# 001 [40 CFR Part 63 NESHAPS for Source Categories §40 CFR 63.997]****Subpart SS - National Emission Standards for Closed Vent Systems, Control Devices, Recovery Devices and Routing to a Fuel Gas System or a Process****Performance test and compliance assessment requirements for control devices.**

The Owner/Operator shall comply with the applicable performance testing and compliance assessment requirements for the Spent Caustic Vent and LP incinerators, MPGF, and HP flares specified in 40 CFR §63.997.

**III. MONITORING REQUIREMENTS.****# 002 [40 CFR Part 63 NESHAPS for Source Categories §40 CFR 63.996]****Subpart SS - National Emission Standards for Closed Vent Systems, Control Devices, Recovery Devices and Routing to a Fuel Gas System or a Process****General monitoring requirements for control and recovery devices.**

The Owner/Operator shall comply with the applicable general monitoring requirements for the Spent Caustic Vent incinerator, LP System, and HP System specified in 40 CFR §63.996.

**IV. RECORDKEEPING REQUIREMENTS.****# 003 [40 CFR Part 63 NESHAPS for Source Categories §40 CFR 63.998]****Subpart SS - National Emission Standards for Closed Vent Systems, Control Devices, Recovery Devices and Routing to a Fuel Gas System or a Process****Recordkeeping requirements.**

The Owner/Operator shall comply with the applicable recordkeeping requirements for organic HAP-containing storage tanks, process vents and equipment leaks specified in 40 CFR §63.998.

**V. REPORTING REQUIREMENTS.****# 004 [40 CFR Part 63 NESHAPS for Source Categories §40 CFR 63.999]****Subpart SS - National Emission Standards for Closed Vent Systems, Control Devices, Recovery Devices and Routing to a Fuel Gas System or a Process****Notifications and other reports.**

The Owner/Operator shall comply with the applicable notification and reporting requirements for organic HAP-containing storage tanks, process vents and equipment leaks specified in 40 CFR §63.999.

**VI. WORK PRACTICE REQUIREMENTS.****# 005 [40 CFR Part 63 NESHAPS for Source Categories §40 CFR 63.982]****Subpart SS - National Emission Standards for Closed Vent Systems, Control Devices, Recovery Devices and Routing to a Fuel Gas System or a Process****Requirements.**

The Owner/Operator shall comply with the applicable requirements for organic HAP-containing storage tanks, process vents and equipment leaks specified in 40 CFR §63.982(a) and (b).

**SECTION E. Source Group Plan Approval Restrictions.****# 006 [40 CFR Part 63 NESHAPS for Source Categories §40 CFR 63.983]****Subpart SS - National Emission Standards for Closed Vent Systems, Control Devices, Recovery Devices and Routing to a Fuel Gas System or a Process****Closed vent systems.**

The Owner/Operator shall comply with the applicable closed vent system requirements for organic HAP-containing storage tanks, process vents and equipment leaks specified in 40 CFR §63.983.

**# 007 [40 CFR Part 63 NESHAPS for Source Categories §40 CFR 63.987]****Subpart SS - National Emission Standards for Closed Vent Systems, Control Devices, Recovery Devices and Routing to a Fuel Gas System or a Process****Flare requirements.**

The Owner/Operator shall comply with the applicable flare requirements for the MPGF, and HP ground flares and elevated flare specified in 40 CFR §63.987.

**# 008 [40 CFR Part 63 NESHAPS for Source Categories §40 CFR 63.988]****Subpart SS - National Emission Standards for Closed Vent Systems, Control Devices, Recovery Devices and Routing to a Fuel Gas System or a Process****Incinerators, boilers, and process heaters.**

The Owner/Operator shall comply with the applicable incinerator requirements for the LP incinerator specified in 40 CFR §63.988.

**VII. ADDITIONAL REQUIREMENTS.****# 009 [40 CFR Part 63 NESHAPS for Source Categories §40 CFR 63.980]****Subpart SS - National Emission Standards for Closed Vent Systems, Control Devices, Recovery Devices and Routing to a Fuel Gas System or a Process****Applicability**

Closed vent systems, control devices, and routing of air emissions to a fuel gas system or process, subject to 40 CFR Part 63 Subpart UU or as referenced in 40 CFR Part 63 Subparts YY and FFFF, are subject to the requirements of 40 CFR Part 63 Subpart SS - National Emission Standards for Closed Vent Systems, Control Devices, Recovery Devices and Routing to a Fuel Gas System or a Process.

**# 010 [40 CFR Part 63 NESHAPS for Source Categories §40 CFR 63.981]****Subpart SS - National Emission Standards for Closed Vent Systems, Control Devices, Recovery Devices and Routing to a Fuel Gas System or a Process****Definitions**

All terms used in 40 CFR Part 63 Subpart SS shall have the meaning given in 40 CFR §63.981 or else in the Clean Air Act.

**SECTION E. Source Group Plan Approval Restrictions.**

Group Name: G09

Group Description: NESHAP Part 63 Subpart FFFF (partial)

Sources included in this group

ID	Name
202	POLYETHYLENE MANUFACTURING LINES
203	PROCESS COOLING TOWER
401	STORAGE TANKS (RECOVERED OIL, EQUALIZATION WASTEWATER)
501	EQUIPMENT COMPONENTS
502	WASTEWATER TREATMENT PLANT (SECONDARY & TERTIARY TREATMENT)

**I. RESTRICTIONS.**

No additional requirements exist except as provided in other sections of this plan approval including Section B (Plan Approval General Requirements).

**II. TESTING REQUIREMENTS.**

No additional testing requirements exist except as provided in other sections of this plan approval including Section B (Plan Approval General Requirements).

**III. MONITORING REQUIREMENTS.**

No additional monitoring requirements exist except as provided in other sections of this plan approval including Section B (Plan Approval General Requirements).

**IV. RECORDKEEPING REQUIREMENTS.**

**# 001 [40 CFR Part 63 NESHAPS for Source Categories §40 CFR 63.2525]**

**Subpart FFFF - National Emission Standards for Hazardous Air Pollutants: Miscellaneous Organic Chemical Manufacturing**

**What records must I keep?**

The Owner/Operator shall comply with the applicable recordkeeping requirements specified in 40 CFR §63.2525.

**V. REPORTING REQUIREMENTS.**

**# 002 [40 CFR Part 63 NESHAPS for Source Categories §40 CFR 63.2445]**

**Subpart FFFF - National Emission Standards for Hazardous Air Pollutants: Miscellaneous Organic Chemical Manufacturing**

**When do I have to comply with this subpart?**

The Owner/Operator shall comply with the applicable compliance deadline and notification requirements specified in 40 CFR §63.2445.

**# 003 [40 CFR Part 63 NESHAPS for Source Categories §40 CFR 63.2515]**

**Subpart FFFF - National Emission Standards for Hazardous Air Pollutants: Miscellaneous Organic Chemical Manufacturing**

**What notifications must I submit and when?**

The Owner/Operator shall comply with the applicable notification requirements specified in 40 CFR §63.2515.

**# 004 [40 CFR Part 63 NESHAPS for Source Categories §40 CFR 63.2520]**

**Subpart FFFF - National Emission Standards for Hazardous Air Pollutants: Miscellaneous Organic Chemical Manufacturing**

**What reports must I submit and when?**

The Owner/Operator shall comply with the applicable reporting requirements specified in 40 CFR §63.2520.

**VI. WORK PRACTICE REQUIREMENTS.**

**# 005 [40 CFR Part 63 NESHAPS for Source Categories §40 CFR 63.2450]**

**Subpart FFFF - National Emission Standards for Hazardous Air Pollutants: Miscellaneous Organic Chemical Manufacturing**

**What are my general requirements for complying with this subpart?**

The Owner/Operator shall comply with the applicable general compliance requirements specified in 40 CFR §63.2450.

**SECTION E. Source Group Plan Approval Restrictions.****# 006 [40 CFR Part 63 NESHAPS for Source Categories §40 CFR 63.2455]****Subpart FFFF - National Emission Standards for Hazardous Air Pollutants: Miscellaneous Organic Chemical Manufacturing****What requirements must I meet for continuous process vents?**

The Owner/Operator shall comply with the applicable requirements for polyethylene manufacturing line continuous process vents specified in 40 CFR §63.2455.

**# 007 [40 CFR Part 63 NESHAPS for Source Categories §40 CFR 63.2465]****Subpart FFFF - National Emission Standards for Hazardous Air Pollutants: Miscellaneous Organic Chemical Manufacturing****What requirements must I meet for process vents that emit hydrogen halide and halogen HAP or PM HAP?**

The Owner/Operator shall comply with the applicable requirements for polyethylene manufacturing line process vents that emit HAP metals specified in 40 CFR §63.2465(a) and (d).

**# 008 [40 CFR Part 63 NESHAPS for Source Categories §40 CFR 63.2485]****Subpart FFFF - National Emission Standards for Hazardous Air Pollutants: Miscellaneous Organic Chemical Manufacturing****What requirements must I meet for wastewater streams and liquid streams in open systems within an MCPU?**

The Owner/Operator shall comply with the applicable requirements for polyethylene manufacturing line wastewater streams and liquid streams in open systems within an MCPU specified in 40 CFR §63.2485.

**# 009 [40 CFR Part 63 NESHAPS for Source Categories §40 CFR 63.2490]****Subpart FFFF - National Emission Standards for Hazardous Air Pollutants: Miscellaneous Organic Chemical Manufacturing****What requirements must I meet for heat exchange systems?**

The Owner/Operator shall comply with the applicable requirements for polyethylene manufacturing line heat exchange systems specified in 40 CFR §63.2490.

**VII. ADDITIONAL REQUIREMENTS.****# 010 [40 CFR Part 63 NESHAPS for Source Categories §40 CFR 63.2435]****Subpart FFFF - National Emission Standards for Hazardous Air Pollutants: Miscellaneous Organic Chemical Manufacturing****Am I subject to the requirements in this subpart?**

The polyethylene manufacturing line affected miscellaneous organic chemical manufacturing process units (process vents, equipment leaks, and wastewater and liquid streams) are subject to the requirements of 40 CFR Part 63 Subpart FFFF – National Emission Standards for Hazardous Air Pollutants: Miscellaneous Organic Chemical Manufacturing.

**# 011 [40 CFR Part 63 NESHAPS for Source Categories §40 CFR 63.2540]****Subpart FFFF - National Emission Standards for Hazardous Air Pollutants: Miscellaneous Organic Chemical Manufacturing****What parts of the General Provisions apply to me?**

The Owner/Operator shall comply with the applicable General Provisions in §§63.1 through 63.15 listed in Table 12 to 40 CFR Part 63 Subpart FFFF as specified in 40 CFR §63.2540.

**# 012 [40 CFR Part 63 NESHAPS for Source Categories §40 CFR 63.2550]****Subpart FFFF - National Emission Standards for Hazardous Air Pollutants: Miscellaneous Organic Chemical Manufacturing****What definitions apply to this subpart?**

All terms used in 40 CFR Part 63 Subpart FFFF shall have the meaning given in 40 CFR §63.2550 or else in the Clean Air Act or other specifically referenced subpart.

**SECTION E. Source Group Plan Approval Restrictions.**

Group Name: G10

Group Description: Liquid Loadout

Sources included in this group

ID	Name
302	LIQUID LOADOUT (RECOVERED OIL)
303	LIQUID LOADOUT (PYROLYSIS FO, LT GASOLINE, PE3 HEAVIES)
304	LIQUID LOADOUT (C3+, BUTENE, ISOPENTANE, ISOBUTANE, C3 REF)
305	LIQUID LOADOUT (BLENDED PITCH)

**I. RESTRICTIONS.**

No additional requirements exist except as provided in other sections of this plan approval including Section B (Plan Approval General Requirements).

**II. TESTING REQUIREMENTS.**

No additional testing requirements exist except as provided in other sections of this plan approval including Section B (Plan Approval General Requirements).

**III. MONITORING REQUIREMENTS.****# 001 [25 Pa. Code §127.12b]****Plan approval terms and conditions.**

The Owner/Operator shall monitor liquid level within loadout storage tanks during loading to avoid overfilling and fugitive emission releases from pressure relief devices.

**# 002 [25 Pa. Code §127.12b]****Plan approval terms and conditions.**

The Owner/Operator shall monitor for pressure relief valve releases during liquid loadout operations. Records of any pressure relief event shall be maintained on site and include the following details at a minimum:

- a. Date and time of the pressure relief event;
- b. Name and title of the observer;
- c. Duration of the event;
- d. Estimated emission rate during the event, and;
- e. Corrective action taken as a result of the event.

**IV. RECORDKEEPING REQUIREMENTS.**

No additional record keeping requirements exist except as provided in other sections of this plan approval including Section B (Plan Approval General Requirements).

**V. REPORTING REQUIREMENTS.**

No additional reporting requirements exist except as provided in other sections of this plan approval including Section B (Plan Approval General Requirements).

**VI. WORK PRACTICE REQUIREMENTS.****# 003 [25 Pa. Code §127.12b]****Plan approval terms and conditions.**

Vapor recovery systems and control devices shall be operated at all times while liquids are being loaded to, or vapors being purged from, loadout storage tanks.

**# 004 [25 Pa. Code §127.12b]****Plan approval terms and conditions.**

Atmospheric pressure liquid loadout storage tanks shall be filled by submerged loading and utilize preset stop-fill devices during loading.

**# 005 [25 Pa. Code §127.12b]****Plan approval terms and conditions.**

**SECTION E. Source Group Plan Approval Restrictions.**

The Owner/Operator shall take any and all reasonable actions to avoid excess drainage of liquids or the emission of excess vapors during the disconnection of hoses after loading of a storage tank.

**# 006 [25 Pa. Code §127.12b]****Plan approval terms and conditions.**

Liquid loadout hoses shall be equipped with OPW's Drylok™ Dry Disconnect Coupling (or equivalent) low-leak couplings.

**VII. ADDITIONAL REQUIREMENTS.**

No additional requirements exist except as provided in other sections of this plan approval including Section B (Plan Approval General Requirements).

**SECTION E. Source Group Plan Approval Restrictions.**

Group Name: G11

Group Description: Storage Tanks

Sources included in this group

ID	Name
401	STORAGE TANKS (RECOVERED OIL, EQUALIZATION WASTEWATER)
402	STORAGE TANK (SPENT CAUSTIC)
403	STORAGE TANKS (LIGHT GASOLINE)
404	STORAGE TANKS (HEXENE)
405	STORAGE TANKS (MISC PRESSURIZED)
406	STORAGE TANKS (DIESEL FUEL > 150 GALLONS)
407	STORAGE TANKS (PYROLYSIS FUEL OIL)

**I. RESTRICTIONS.**

No additional requirements exist except as provided in other sections of this plan approval including Section B (Plan Approval General Requirements).

**II. TESTING REQUIREMENTS.**

No additional testing requirements exist except as provided in other sections of this plan approval including Section B (Plan Approval General Requirements).

**III. MONITORING REQUIREMENTS.**

No additional monitoring requirements exist except as provided in other sections of this plan approval including Section B (Plan Approval General Requirements).

**IV. RECORDKEEPING REQUIREMENTS.**

No additional record keeping requirements exist except as provided in other sections of this plan approval including Section B (Plan Approval General Requirements).

**V. REPORTING REQUIREMENTS.**

No additional reporting requirements exist except as provided in other sections of this plan approval including Section B (Plan Approval General Requirements).

**VI. WORK PRACTICE REQUIREMENTS.****# 001 [25 Pa. Code §129.56]****Storage tanks greater than 40,000 gallons capacity containing VOCs**

Storage tanks greater than 40,000 gallons capacity containing VOCs

a. No person may permit the placing, storing or holding in a stationary tank, reservoir or other container with a capacity greater than 40,000 gallons of volatile organic compounds with a vapor pressure greater than 1.5 psia (10.5 kilopascals) under actual storage conditions unless the tank, reservoir or other container is a pressure tank capable of maintaining working pressures sufficient at all times to prevent vapor or gas loss to the atmosphere or is designed and equipped with one of the following vapor loss control devices:

- 1) An external or an internal floating roof. This control equipment may not be permitted if the volatile organic compounds have a vapor pressure of 11 psia (76 kilopascals) or greater under actual storage conditions.
- 2) Vapor recovery system. A vapor recovery system, consisting of a vapor gathering system capable of collecting the volatile organic compound vapors and gases discharged and a vapor disposal system capable of processing such volatile organic vapors and gases so as to prevent their emission to the atmosphere. Tank gauging and sampling devices shall be gas-tight except when gauging or sampling is taking place. The vapor recovery system shall be maintained in good working order and recover at least 80% of the vapors emitted by such tank.

b. N/A

**SECTION E. Source Group Plan Approval Restrictions.**

c. An internal floating roof shall be fitted with a primary seal and shall comply with the following equipment requirements:

- 1) A closure seal or seals, to close the space between the roof edge and tank wall is used.
- 2) There are no holes, tears or other openings in the seal or a seal fabric or materials.
- 3) Openings except stub drains are equipped with covers, lids or seals such that:
  - i. The cover, lid or seal is in the closed position at all times except when in actual use.
  - ii. Automatic bleeder vents are closed at all times except when the roof is floated off or landed on the roof leg supports.
  - iii. Rim vents, if provided are set to open when the roof is being floated off the roof leg supports or at the recommended setting of the manufacturer.

d. This section does not apply to petroleum liquid storage vessels which:

- 1) Are used to store waxy, heavy pour crude oil.
- 2) Have capacities less than 420,000 gallons and are used to store produced crude oil and condensate prior to lease custody transfer.

e. For the purposes of this section, the petroleum liquid storage vessels listed in this subsection comply with the equipment requirements of this section. These tanks shall comply with the maintenance, inspection and reporting requirements of this section. These petroleum liquid storage vessels are those:

- 1) Which contain a petroleum liquid with a true vapor pressure less than 4 psia (27.6 kilopascals) and which are of welded construction and which presently possess a metallic-type shoe seal, a liquid-mounted foam seal, a liquid-mounted liquid filled type seal or other closure device of demonstrated equivalence approved by the Department.
- 2) Which are of welded construction, equipped with a metallic-type shoe primary seal and has a secondary seal from the top of the shoe seal to the tank wall (shoe-mounted secondary seal).

f. The owner or operator of a petroleum liquid storage vessel with a floating roof subject to this regulation shall:

- 1) Perform routine inspections annually in order to insure compliance with subsection (b) or (c). The inspection shall include a visual inspection of the secondary seal gap when inspecting external floating roof tanks.
- 2) For external floating roof tanks, measure the secondary seal gap annually in accordance with subsection (b)(1)(iii) when the floating roof is equipped with a vapor-mounted primary seal.
- 3) Maintain records of the types of volatile petroleum liquids stored, the maximum true vapor pressure of the liquid as stored, and the results of the inspections performed in subsection (f)(1) and (2). Copies of the records shall be retained by the owner or operator for a period of 2 years after the date on which the record was made and shall be made available to the Department upon written or verbal request at a reasonable time.

g. For volatile organic compounds whose storage temperature is governed by ambient weather conditions, the vapor pressure under actual storage conditions shall be determined using a temperature which is representative of the average storage temperature for the hottest month of the year in which the storage takes place.

h. If a failure is detected during inspections required in this section, the owner or operator, or both, shall repair the items or empty and remove the storage vessel from service within 45 days. If this failure cannot be repaired within 45 days and if the vessel cannot be emptied within 45 days, a 30-day extension may be requested from the Department. A request for an extension shall document that alternate storage capacity is unavailable and specify a schedule of actions the owner or operator will take that will assure that the equipment will be repaired or the vessel will be emptied as soon as possible but within the additional 30-day time requested.

**# 002 [25 Pa. Code §129.57]****Storage tanks less than or equal to 40,000 gallons capacity containing VOCs**

The provisions of this section shall apply to above ground stationary storage tanks with a capacity equal to or greater than 2,000 gallons which contain volatile organic compounds with vapor pressure greater than 1.5 psia (10.5 kilopascals) under actual storage conditions. Storage tanks covered under this section shall have pressure relief valves which are maintained in good operating condition and which are set to release at no less than .7 psig (4.8 kilopascals) of pressure or .3 psig (2.1 kilopascals) of vacuum or the highest possible pressure and vacuum in accordance with state or local fire codes or the National Fire Prevention Association guidelines or other national consensus standards acceptable to the Department. Section 129.56(g) (relating to storage tanks greater than 40,000 gallons capacity containing volatile organic compounds)

**SECTION E. Source Group Plan Approval Restrictions.**

applies to this section. Petroleum liquid storage vessels which are used to store produced crude oil and condensate prior to lease custody transfer shall be exempt from the requirements of this section.

**VII. ADDITIONAL REQUIREMENTS.**

No additional requirements exist except as provided in other sections of this plan approval including Section B (Plan Approval General Requirements).

**SECTION E. Source Group Plan Approval Restrictions.**

Group Name: G12

Group Description: NSPS Part 60 Subpart VV and NESHAP Part 63 Subpart FFFF (partial)

Sources included in this group

ID	Name
202	POLYETHYLENE MANUFACTURING LINES
501	EQUIPMENT COMPONENTS

**I. RESTRICTIONS.****Control Device Efficiency Restriction(s).****# 001 [40 CFR Part 60 Standards of Performance for New Stationary Sources §40 CFR 60.482-10]****Subpart VV - Standards of Performance for Equipment Leaks of VOC in the Synthetic Organic Chemicals Manufacturing Industry****Standards: Closed vent systems and control devices.**

The Owner/Operator shall comply with the applicable standards for closed vent systems and control devices specified in 40 CFR §60.482-10.

**II. TESTING REQUIREMENTS.****# 002 [40 CFR Part 60 Standards of Performance for New Stationary Sources §40 CFR 60.485]****Subpart VV - Standards of Performance for Equipment Leaks of VOC in the Synthetic Organic Chemicals Manufacturing Industry****Test methods and procedures.**

The Owner/Operator shall comply with the applicable test methods and procedures specified in 40 CFR §60.485.

The following provision may be used in addition to §60.485(e): Equipment is in light liquid service if the percent evaporated is greater than 10 percent at 150 °C (302 °F) as determined by ASTM Method D86-78, 82, 90, 95, or 96 (incorporated by reference as specified in §60.17).

**III. MONITORING REQUIREMENTS.**

No additional monitoring requirements exist except as provided in other sections of this plan approval including Section B (Plan Approval General Requirements).

**IV. RECORDKEEPING REQUIREMENTS.****# 003 [40 CFR Part 60 Standards of Performance for New Stationary Sources §40 CFR 60.486]****Subpart VV - Standards of Performance for Equipment Leaks of VOC in the Synthetic Organic Chemicals Manufacturing Industry****Recordkeeping requirements.**

The Owner/Operator shall comply with the applicable recordkeeping requirements specified in 40 CFR §60.486.

**V. REPORTING REQUIREMENTS.****# 004 [40 CFR Part 60 Standards of Performance for New Stationary Sources §40 CFR 60.487]****Subpart VV - Standards of Performance for Equipment Leaks of VOC in the Synthetic Organic Chemicals Manufacturing Industry****Reporting requirements.**

The Owner/Operator shall comply with the applicable reporting requirements specified in 40 CFR §60.487.

**VI. WORK PRACTICE REQUIREMENTS.****# 005 [40 CFR Part 60 Standards of Performance for New Stationary Sources §40 CFR 60.482-1]****Subpart VV - Standards of Performance for Equipment Leaks of VOC in the Synthetic Organic Chemicals Manufacturing Industry****Standards: General.**

The Owner/Operator shall comply with the applicable general standards specified in 40 CFR §60.482-1.

**SECTION E. Source Group Plan Approval Restrictions.**

<p><b># 006 [40 CFR Part 60 Standards of Performance for New Stationary Sources §40 CFR 60.482-2]</b> <b>Subpart VV - Standards of Performance for Equipment Leaks of VOC in the Synthetic Organic Chemicals Manufacturing Industry</b> <b>Standards: Pumps in light liquid service.</b></p> <p>The Owner/Operator shall comply with the applicable standards for pumps in light liquid service specified in 40 CFR §60.482-2.</p>
<p><b># 007 [40 CFR Part 60 Standards of Performance for New Stationary Sources §40 CFR 60.482-3]</b> <b>Subpart VV - Standards of Performance for Equipment Leaks of VOC in the Synthetic Organic Chemicals Manufacturing Industry</b> <b>Compressors.</b></p> <p>The Owner/Operator shall comply with the applicable standards for compressors specified in 40 CFR §60.482-3.</p>
<p><b># 008 [40 CFR Part 60 Standards of Performance for New Stationary Sources §40 CFR 60.482-4]</b> <b>Subpart VV - Standards of Performance for Equipment Leaks of VOC in the Synthetic Organic Chemicals Manufacturing Industry</b> <b>Standards: Pressure relief devices in gas/vapor service.</b></p> <p>The Owner/Operator shall comply with the applicable standards for pressure relief devices in gas/vapor service specified in 40 CFR §60.482-4.</p>
<p><b># 009 [40 CFR Part 60 Standards of Performance for New Stationary Sources §40 CFR 60.482-5]</b> <b>Subpart VV - Standards of Performance for Equipment Leaks of VOC in the Synthetic Organic Chemicals Manufacturing Industry</b> <b>Standards: Sampling connection systems.</b></p> <p>The Owner/Operator shall comply with the applicable standards for sampling connection systems specified in 40 CFR §60.482-5.</p>
<p><b># 010 [40 CFR Part 60 Standards of Performance for New Stationary Sources §40 CFR 60.482-6]</b> <b>Subpart VV - Standards of Performance for Equipment Leaks of VOC in the Synthetic Organic Chemicals Manufacturing Industry</b> <b>Standards: Open-ended valves or lines.</b></p> <p>The Owner/Operator shall comply with the applicable standards for open-ended valves or lines specified in 40 CFR §60.482-6.</p>
<p><b># 011 [40 CFR Part 60 Standards of Performance for New Stationary Sources §40 CFR 60.482-7]</b> <b>Subpart VV - Standards of Performance for Equipment Leaks of VOC in the Synthetic Organic Chemicals Manufacturing Industry</b> <b>Standards: Valves in gas/vapor service and in light liquid service.</b></p> <p>The Owner/Operator shall comply with the applicable standards for valves in gas/vapor service and in light liquid service specified in 40 CFR §60.482-7.</p>
<p><b># 012 [40 CFR Part 60 Standards of Performance for New Stationary Sources §40 CFR 60.482-8]</b> <b>Subpart VV - Standards of Performance for Equipment Leaks of VOC in the Synthetic Organic Chemicals Manufacturing Industry</b> <b>Standards: Pumps and valves in heavy liquid service, pressure relief devices in light liquid or heavy liquid service, and connectors.</b></p> <p>The Owner/Operator shall comply with the applicable standards for pumps and valves in heavy liquid service, pressure relief devices in light liquid or heavy liquid service, and connectors specified in 40 CFR §60.482-8.</p>
<p><b># 013 [40 CFR Part 60 Standards of Performance for New Stationary Sources §40 CFR 60.482-9]</b> <b>Subpart VV - Standards of Performance for Equipment Leaks of VOC in the Synthetic Organic Chemicals Manufacturing Industry</b> <b>Standards: Delay of repair.</b></p> <p>The Owner/Operator shall comply with the applicable standards for delays of repair specified in 40 CFR §60.482-9.</p>
<p><b># 014 [40 CFR Part 63 NESHAPS for Source Categories §40 CFR 63.2480]</b> <b>Subpart FFFF - National Emission Standards for Hazardous Air Pollutants: Miscellaneous Organic Chemical Manufacturing</b> <b>What requirements must I meet for equipment leaks?</b></p>

**SECTION E. Source Group Plan Approval Restrictions.**

The Owner/Operator shall comply with the applicable requirements for polyethylene manufacturing line equipment leaks specified in 40 CFR §63.2480.

**VII. ADDITIONAL REQUIREMENTS.****# 015 [40 CFR Part 60 Standards of Performance for New Stationary Sources §40 CFR 60.484]****Subpart VV - Standards of Performance for Equipment Leaks of VOC in the Synthetic Organic Chemicals Manufacturing Industry****Equivalence of means of emission limitation.**

The Owner/Operator may apply to the Administrator for a determination of equivalence for any means of emission limitation that achieves a reduction in emissions of VOC at least equivalent to the reduction in emissions of VOC achieved by the controls required in 40 CFR Part 60 Subpart VV as specified in 40 CFR §60.484.

**# 016 [40 CFR Part 63 NESHAPS for Source Categories §40 CFR 63.2435]****Subpart FFFF - National Emission Standards for Hazardous Air Pollutants: Miscellaneous Organic Chemical Manufacturing****Am I subject to the requirements in this subpart?**

The polyethylene manufacturing line affected miscellaneous organic chemical manufacturing process units (process vents, equipment leaks, and wastewater and liquid streams) are subject to the requirements of 40 CFR Part 63 Subpart FFFF – National Emission Standards for Hazardous Air Pollutants: Miscellaneous Organic Chemical Manufacturing.



## SECTION F. Alternative Operation Requirements.

No Alternative Operations exist for this Plan Approval facility.



**SECTION G. Emission Restriction Summary.**

No emission restrictions listed in this section of the permit.

**SECTION H. Miscellaneous.**

This is a major Title V facility for NO<sub>x</sub>, CO, PM<sub>10</sub>, PM<sub>2.5</sub>, VOC, Hexane, Total HAP, and CO<sub>2e</sub> and as such, actual emissions may equal or exceed the following in any consecutive 12-month period.

100.0 tons of NO<sub>x</sub> (NITROGEN OXIDES)

100.0 tons of CO (CARBON MONOXIDE)

100.0 tons of PM-10 (PARTICULATE MATTER < 10 MICRONS)

100.0 tons of PM-2.5 (PARTICULATE MATTER < 2.5 MICRONS)

50.0 tons of VOC (VOLATILE ORGANIC COMPOUNDS)

10.0 tons of HEXANE

25.0 tons of ALL HAP COMBINED (HAZARDOUS AIR POLLUTANT)

This is a natural minor facility with respect to SO<sub>x</sub> and as such, actual emissions can not equal or exceed the following in any consecutive 12-month period:

100.0 tons of SO<sub>x</sub> (SULFUR OXIDES)



\*\*\*\*\* End of Report \*\*\*\*\*

---



**TO** Air Quality Permit File: PA-04-00740A, B, & C

**FROM** Alexander Sandy/AS  
Air Quality Engineering Specialist  
Air Quality Program

**THROUGH** Sheri L. Guerrieri, P.E./slg  
Environmental Engineer Manager  
Air Quality Program

Mark R. Gorog, P.E./MRG  
Regional Manager  
Air Quality Program

**DATE** April 7, 2026

**RE** Plan Approval Extension  
Shell Chemical Appalachia LLC  
Shell Polymers Monaca  
Potter and Center Townships, Beaver County  
PA-04-00740A: APS 913256; Auth 1563456; PF 775836  
PA-04-00740B: APS 1008145; Auth 1563469; PF 775836  
PA-04-00740C: APS 1011255; Auth 1563475; PF 775836

On March 23, 2026, the Department received plan approval extension applications from Shell Chemical Appalachia LLC to extend the temporary operation period of the sources authorized under the above listed plan approvals at Shell Polymers Monaca located in Potter and Center Townships, Beaver County. The plan approvals currently expire on April 28, 2026.

In accordance with PA-04-00740A, B, and C, Section B, Condition #003(d),

“The permittee may request an extension of the 180-day shakedown period if further evaluation of the air contamination aspects of the source(s) is necessary. The request for an extension shall be submitted, in writing, to the Department at least 30 days prior to the end of the initial 180-day shakedown period and shall provide a description of the compliance status of the source, a detailed schedule for establishing compliance, and the reasons compliance has not been established. This temporary operation period will be valid for a limited time and may be extended for additional limited periods, each not to exceed 180 days.”

In order to authorize continued temporary operation, I recommend extension of the plan approvals until October 28, 2026.



Shell Chemical Appalachia LLC  
300 Frankfort Rd  
Monaca, PA 15061

March 19, 2026

Mark Gorog, P.E.  
Air Quality Program Regional Manager  
Pennsylvania Department of Environmental Protection  
Southwest Regional Office  
400 Waterfront Drive  
Pittsburgh, PA 15222

**RE: Shell Chemical Appalachia LLC  
Shell Polymers Monaca  
Potter and Center Townships, Beaver County  
Plan Approval No. 04-00740A  
Plan Approval Temporary Operation Extension Request**

Dear Mr. Gorog:

Shell Chemical Appalachia LLC ("Shell") is requesting an extension of Plan Approval 04-00740A, along with our other associated Plan Approvals (04-00740B and 04-00740C), to extend temporary operation of commenced sources and to authorize the continued commissioning of sources and controls at Shell Polymers Monaca.

The following documents are included in the extension request:

- Plan Approval Extension Form (completed and signed)
- Air Pollution Control Act Compliance Review Supplemental Form (completed and signed)
- Justification for the extension
- Schedule for the completion of the construction

The extension request was submitted via Pennsylvania Department of Environmental Protection's (PADEP's) OnBase Electronic Forms Upload platform. The application fee of \$900 for the application was paid via credit card through OnBase.

Please contact Alan Binder at 724-709-2506 or [Alan.Binder@shell.com](mailto:Alan.Binder@shell.com) if you have any questions or need additional information.

Sincerely,

Nathan Levin  
Operations Manager



**PLAN APPROVAL EXTENSION FORM**

Current Plan Approval Information				
Plan Approval No.: 04-00740A		Owner Name: Shell Chemical Appalachia LLC		
Original Issued Date: 6/18/2015		Plant Name: Shell Polymers Monaca		
Current Expiration Date: 04/28/2026		Contact Name: Laura Sabolyk		
Project Commenced Date: 2/10/2016		Contact Title: Senior Regulatory Advisor		
Contact Telephone: 724-709-2906		Contact Email: laura.l.sabolyk@shell.com		
Municipality: Potter & Center Twp		Mailing Address: 300 Frankfort Road		
County: Beaver		City: Monaca	State: PA	Zip Code: 15061
List of Source(s) and/or Air Cleaning Devices Specified in the Plan Approval (attach additional pages as needed)				
Source ID	Source Name	Air Cleaning Device	Date of Completion	Operational Commencement Date
	See attached schedule			
Reason for Extension (see instructions)				
<input checked="" type="checkbox"/> (A) Plan Approval Extension to continue construction, modification, reactivation of the source(s) or installation of air cleaning device(s) in accordance with 25 Pa. Code §127.13(a).				
<input checked="" type="checkbox"/> (B) Plan Approval Extension to extend temporary operation to facilitate the shake-down of sources and air cleaning devices, to permit operation pending issuance of a permit under Subchapter F (relating to operating permit requirements) or Subchapter G (relating to Title V operating permits) or to allow the evaluation of the source(s) for compliance with applicable regulations and requirements in accordance with 25 Pa. Code §127.12b(d).				
<input type="checkbox"/> (C) Other (including the extension of the 18-month period specified in 25 Pa. Code §127.13(b)).				
Checklist				
<input checked="" type="checkbox"/> Included Air Quality Fees Schedule				
<input type="checkbox"/> Fees are not required in accordance with 25 Pa. Code § 127.702(i)(3); justification included				
<input checked="" type="checkbox"/> Included justification for the extension request				
<input checked="" type="checkbox"/> Included complete Compliance Review Form or Compliance Review Supplemental Form if one has not been submitted within 6 months from the date of this application				
<input checked="" type="checkbox"/> Plan Approval Extension Form signed by a responsible official				
Certification of Truth, Accuracy and Completeness				
I certify that, subject to the penalties of Title 18 Pa. C.S.A. Section 4904 and 35 P.S. Section 4009(b)(2), I am the responsible official having primary responsibility for the design and operation of the facilities to which this application applies and that the information provided in this application is true, accurate, and complete to the best of my knowledge, information, and belief formed after reasonable inquiry.				
Name (Type): Nathan Levin			Title: Operations Manager	
Name (Signed):			Date: 3-23-26	



COMMONWEALTH OF PENNSYLVANIA  
DEPARTMENT OF ENVIRONMENTAL PROTECTION  
BUREAU OF AIR QUALITY

## AIR POLLUTION CONTROL ACT COMPLIANCE REVIEW SUPPLEMENTAL FORM

Fully and accurately provide the following information, as specified. Attach additional sheets as necessary.

**Date of Submission of Original Compliance Review Form** 05/01/2014

**Type of Supplemental Compliance Review Form Submittal (check all that apply)**

- Original Filing                       Amended Filing  
 No Changes                               Date of Last Compliance Review Form Filing      9/13/2024

**Type of Submittal**

- New Plan Approval                       New Operating Permit                       Renewal of Operating Permit  
 Extension of Plan Approval               Change of Ownership                       Periodic Submission  
 Other \_\_\_\_\_ (every six months)

### SECTION A. GENERAL APPLICANT INFORMATION

**1. Name of Applicant/Permittee/("Applicant")** (non-corporations attach documentation of legal name)

Shell Chemical Appalachia LLC

Address 300 Frankfort Road  
Monaca, PA 15061

Telephone 724-709-2467

Taxpayer ID# 46-1624986

Permit, Plan Approval or Application ID# PA-04-00740A

**2. Identify the form of management under which the applicant conducts its business.**

- Individual                                       Fictitious Name                                       Association  
 Municipality                                       Partnership                                               Syndicate  
 Proprietorship                                       Limited Partnership  
 Public corporation                                       Government Agency  
 Private Corporation                                       Joint Venture  
 Municipal Authority                                       Other Type of Business (specify)      Limited Liability Company

**3. Describe the type(s) of business activities performed.**

\*\*\* Supplemental \*\*\*

List only those changes since the date of the last original submission.

No Changes

**SECTION B. GENERAL INFORMATION REGARDING "APPLICANT"**

If applicant is a corporation or a division or other unit of a corporation, provide the names, principal places of business, state of incorporation, and taxpayer ID numbers of all domestic and foreign parent corporations (including the ultimate parent corporation), and all domestic and foreign subsidiary corporations of the ultimate parent corporation with operations in Pennsylvania. Please include all corporate divisions or units, (whether incorporated or unincorporated) and privately held corporations. (A diagram of corporate relationships may be provided to illustrate corporate relationships.) Attach additional sheets as necessary.

\*\*\* Supplemental \*\*\*

List only those changes since the date of the last original submission.

Unit Name	Principal Places of Business	State of Incorporation	Taxpayer ID	Relationship to Applicant
No Changes				

**SECTION C. INFORMATION REGARDING APPLICANT & ITS "RELATED PARTIES"**

**1. Pennsylvania Facilities.** List the name and location (mailing address, municipality, county), telephone number, and relationship to applicant (parent, subsidiary or general partner) of all Related Parties' places of business, and facilities in Pennsylvania. Attach additional sheets as necessary.

\*\*\* Supplemental \*\*\*

List only those changes since the date of the last original submission.

Unit Name	Street Business	County and Municipality	Telephone No.	Relationship to Applicant
No Changes				

**2. General Partners.** Provide the names and business addresses of all general partners of the applicant and parent corporation, if any.

\*\*\* Supplemental \*\*\*

List only those changes since the date of the last original submission.

Name	Business Address
No Changes	

**3. Management Responsibility.** Provide the names and business of persons with overall management responsibility for the process being permitted (i.e., plant manager).

\*\*\* Supplemental \*\*\*

List only those changes since the date of the last original submission.

Name	Business Address
Nathan Levin Operations Manager Shell Chemical Appalachia LLC	Shell Chemical Appalachia LLC 300 Frankfort Road Monaca, PA 15061

**4. Plan Approvals or Operating Permits.** List all plan approvals or operating permits issued by the Department or an approved local air pollution control agency under the APCA to the applicant or related parties that are currently in effect or have been in effect at any time five years prior to the date on which this form is notarized. This list shall include the plan approval and operating permit numbers, locations, issuance and expiration dates. Attach additional sheets as necessary.

\* \* \* Supplemental \* \* \*

List only those changes since the date of the last original submission.

Source	Plan Approval Operating Permit Number	Location	Issuance Date	Expiration Date
No Changes				

**SECTION D. COMPLIANCE BACKGROUND**

*Note: Copies of specific documents, if applicable, must be made available to the Department upon its request.)*

**1. Documented Conduct.** List all documented conduct of violations or enforcement actions identified by the Department pursuant to the APCA, regulations, terms and conditions of an operating permit or plan approval or order by applicant or any related party, using the following format grouped by source and location in reverse chronological order. Attach additional sheets as necessary. See the definition of "documented conduct" for further clarification. Unless specifically directed by the Department, deviations which have been previously reported to the Department in writing, relating to monitoring and reporting, need not be reported.

\* \* \* Supplemental \* \* \*

List only those changes since the date of the last original submission.

Date	Location	Plan Approval/ Operating Permit#	Nature of Documented Conduct	Type of Department Action	Status Litigation; Existing / Continuing; or corrected/Date	Dollar Amount Penalty
12/19/2025	Shell Polymers Monaca	PA-04-00740A/B/C	Exceedances of 12-Month Emission Limitations for NOx [November 2025]	Notice of Violation	Pending	TBD
1/23/2026	Shell Polymers Monaca	PA-04-00740A/B/C	Exceedances of 12-Month Emission Limitations for NOx [December 2025]	Notice of Violation	Pending	TBD
2/17/2026	Shell Polymers Monaca	PA-04-00740A/B/C	Exceedances of 12-Month Emission Limitations for NOx [January 2026]	Notice of Violation	Pending	TBD

**CONTINUING OBLIGATION:** Applicant is under a continuing obligation to update this form using the Compliance Review Supplemental Form if any additional documented conduct occurs or related parties develop between the date of submission and Department action on its application

**2. Incidents of Deviation.** List all incidents of deviations of the APCA, regulations, terms and conditions of an operating permit or plan approval or order by applicant or any related party, using the following format grouped by source and location in reverse chronological order. This list must include items both currently known and unknown to the Department. Attach additional sheets as necessary. See the definition of "deviations" for further clarification.

\* \* \* Supplemental \* \* \*

List only those changes since the date of the last original submission.

Date	Location	Plan Approval/ Operating Permit#	Nature of Deviation	Incident Status: Existing/Continuing; or Corrected Date
2022 to present	Shell Polymers Monaca	PA-04-00740A/C	Maximum designed water circulation rate through the cogeneration cooling tower is greater than limit in permit.	Continuing deviation. Correcting the designed water circulation rate for as-built in the plan approval application "D".
Q4 2022 (Furnace 5) Q1-Q4 2023 (Furnaces 1-7) Q1-Q4 2024 (Furnaces 1-7)	Shell Polymers Monaca	PA-04-00740A/C	Cracking Furnaces CEMS Report: Reports required to be resubmitted due to inaccurate data from Density Analyzer B, resulting in inaccurate mass fuel gas consumption and resulting NOx and CO emissions.	Existing deviation. Updated. Density analyzer settings were corrected on November 19, 2024. As of 8/18/2025, PADEP approved use of Density Analyzer A for historical data, and quarterly CEMS reports must be re-submitted with "A" data when it is available and valid. Quarterly CEMS reports must be submitted for the Q4 2022 for Furnace 5 only, Q1-Q4 2023 for all furnaces, and Q1-Q4 2024 for all furnaces. Revised reports have been submitted and approved through Q3 2023, and additional quarters are in progress.
2/1/2024 to present	Shell Polymers Monaca	PA-04-00740A/C	Site-wide NOx 12-month rolling limitation: The COA expired at the end of January 2024. Site remains non-compliant with emission limitation.	Continuing deviation. Engineering improvements and permitting corrections to match facility design. Proposed to be resolved in plan approval application "D".
5/23/2024 Test Date	Shell Polymers Monaca	PA-04-00740A/C	SCTO stack test results not compliant with emission limitations for NOx.	Continuing Deviation. NOx: Burner tip modifications occurred in December 2024 but did not yield a passing NOx emission factor. Interim mitigations in place include Limiting the combustion temperature setpoint to ensure NOx lb/hr stays below the PTE basis, optimizing the air-to-fuel ratio for the modified burner tips, and relocating the natural gas valve to improve burner tuning. Final corrective action is pending burner replacement for reduced NOx emissions following issuance of plan approval "D".
12/30/2025	Shell Polymers Monaca	PA-04-00740A/C	Updated applicability of ECU reactor processes as subject to 40 CFR Part 60 Subpart RRR but exempt due to venting to a 40 CFR Part 60 Subpart NNN distillation operation. Previously interpreted exemption through 40 CFR Part 63 Subpart YY (EMACT) overlap. An initial notice is required to be submitted. No deviations from any applicable controls requirements.	Corrected. Notice submitted in Q1 2026.

**2. Incidents of Deviation.** List all incidents of deviations of the APCA, regulations, terms and conditions of an operating permit or plan approval or order by applicant or any related party, using the following format grouped by source and location in reverse chronological order. This list must include items both currently known and unknown to the Department. Attach additional sheets as necessary. See the definition of “deviations” for further clarification.

\* \* \* Supplemental \* \* \*

List only those changes since the date of the last original submission.

Date	Location	Plan Approval/ Operating Permit#	Nature of Deviation	Incident Status: Existing/Continuing; or Corrected Date
12/30/2025	Shell Polymers Monaca	PA-04-00740A/C	Updated applicability of ECU distillation operations as subject to 40 CFR Part 60 Subpart NNN. Previously interpreted exemption through 40 CFR Part 63 Subpart YY (EMACT) overlap. An initial notice and semi-annual reports are required to be submitted. No deviations from any applicable controls requirements.	Corrected. Notice and reports submitted in Q1 2026.
12/30/2025	Shell Polymers Monaca	PA-04-00740A/C	Updated applicability of Hexene storage tanks as subject to 40 CFR Part 60 Subpart Kb. Previously interpreted exemption through 40 CFR Part 63 Subpart FFFF (MON) overlap. A CVTO control plan and semi-annual reports are required to be submitted. No new deviations from any applicable controls requirements.	Corrected. Notice and reports submitted in Q1 2026.
FEORs/ROT Blower Downtime: 1/2026: ~4 min 2/2026: ~0.3 hrs  Spent Caustic Blower Downtime: 2/2026: ~7 min	Shell Polymers Monaca	PA-04-00740A/C  RFD 10277; Approval Date 8/9/2023 for WEMCO/EC-15	SCTO Blower Downtime. Small amounts of excess emissions from FEOR A/B, recovered oil, spent caustic storage tanks, and temporary WEMCO and EC-15 Units due to blower issues where emissions did not go to the SCTO. The tanks are internal floating roof tanks with minimal uncontrolled emissions.	Corrected after each incident.
1/14/2026	Shell Polymers Monaca	PA-04-00740A/C	Cracking Furnaces: Two or more furnaces operated with NOx emissions greater than 6.20 lb/hr at any time: 1/14/2026 Hour 14: Furnaces 1, 2, 3	Corrected after each incident. Each deviation has been or will be addressed in quarterly CEMS supplemental reports.
1/15/2026	Shell Polymers Monaca	PA-04-00740A/C	Cracking Furnace 5: Upon restart after a maintenance outage, debris was found to have entered the fuel gas line and affected fuel meter readings from one of the two vortex fuel flow meters. It is expected that NOx and CO In/MMBtu and lb/hr calculated CEMS emissions will not meet valid data availability minimums for Q1 26 CEMS reporting.	Corrected. Furnace 5 shut down on February 14, 2026, for maintenance. Both fuel meters were replaced with new calibrated fuel meters prior to restart on March 2, 2026.
1/15/2026 1/24/2026 1/30/2026	Shell Polymers Monaca	PA-04-00740A/C	Cracking Furnaces: Exceeded NH3 10 ppmvd at 3% O2, daily average: 1/15/2026 Furnace 4 1/24/2026 Furnace 6 1/30/2026 Furnace 6	Corrected after each incident.

**2. Incidents of Deviation.** List all incidents of deviations of the APCA, regulations, terms and conditions of an operating permit or plan approval or order by applicant or any related party, using the following format grouped by source and location in reverse chronological order. This list must include items both currently known and unknown to the Department. Attach additional sheets as necessary. See the definition of “deviations” for further clarification.

\*\*\* Supplemental \*\*\*

List only those changes since the date of the last original submission.

Date	Location	Plan Approval/ Operating Permit#	Nature of Deviation	Incident Status: Existing/Continuing; or Corrected Date
1/22/2026 1/30/2026	Shell Polymers Monaca	PA-04- 00740A/C	Cracking Furnaces: Exceeded NOx 6.2 lbs/hr during decoking, hot steam standby, feed in or feed out: 1/22/2026 Furnace 5: 1 hr 1/30/2026 Furnace 6: 1 hr	Corrected after each incident. Each deviation has been or will be addressed in quarterly excess emission reports.
1/31/2026	Shell Polymers Monaca	PA-04- 00740A/C	Residual VOC Content Sampling for PE Unit. Missed the required sampling: PE2 Unit on 1/31/2025	Corrected. Shell is continuing to improve sampling procedures and pellet grade tracking.

**CONTINUING OBLIGATION:** Applicant is under a continuing obligation to update this form using the Compliance Review Supplemental Form if any additional documented conduct occur or related parties develop between the date of submission and Department action on its application

### VERIFICATION STATEMENT

Subject to the penalties of Title 18 Pa.C.S. Section 4904 and 35 P.S. Section 4009(b)(2), I verify under penalty of law that I am authorized to make this verification on behalf of the Applicant/Permittee. I further verify that the information contained in this Compliance Review Supplemental Form is true and complete to the best of my belief formed after reasonable inquiry. I further verify that reasonable procedures are in place to ensure that "documented conduct" and "deviations" as defined in 25 Pa Code Section 121.1 are identified and included in the information set forth in this Compliance Review Supplemental Form.



Signature

3-23-26

Date

Nathan Levin

Name (Print or Type)

Operations Manager

Title

**Attachment A**  
**Plan Approval Extension Justification**

Shell is required to request an extension of the plan approvals until the Title V Operating Permit (TVOP) is issued. In accordance with PA-04-00740A, Section B, Condition #003 (d), Shell is requesting an extension of the 180-day shakedown period to continue temporary operation of sources that have commenced operation. PA-04-00740A was first issued on June 18, 2015, and PA-04-00740B and C were issued on February 18, 2021, with all three permits expiring on April 28, 2026.

Shell submitted the initial *Title V Operating Permit Application* to PADEP on June 19, 2024, in response to a February 22, 2024, letter from PADEP requiring the submission of a TVOP application by June 21, 2024. Then, on September 13, 2024, Shell submitted a *Plan Approval Application* to PADEP to i) propose permanent Wastewater Treatment Plant (WWTP) controls, ii) request incorporation of the appropriate Ethylene Maximum Achievable Control Technology (EMACT) requirements into the permit, and iii) reconcile specific plan approval source descriptions, potential-to-emit calculations, and conditions within the permit. Since the submission of the applications, Shell has participated in numerous meetings with PADEP and has submitted additional data as requested by PADEP. The TVOP application was updated and resubmitted on January 21, 2026, in response to technical deficiency notice from PADEP and to incorporate content from the September 2024 plan approval application. As of the date of submission of this extension application, neither an updated plan approval nor a TVOP has been issued by PADEP.

Therefore, Shell is requesting an extension of the Plan Approvals A, B and C until a TVOP is issued by PADEP in response to the application submitted in June 2024 and updated in January 2026.

## Attachment B

List of Source(s) and/or Air Cleaning Devices Specified in Plan Approval No. 04-00740 A, B and C

Source ID	Source Name	Air Cleaning Device	Date of Completion	Operational Commencement Date
031	Ethane Cracking Furnace #1		July 6, 2022	July 30, 2022, lit burners to start dry out. Ethane feed in Sep. 5, 2022.
032	Ethane Cracking Furnace #2		July 6, 2022	May 27, 2022, lit burners to start dry out. Ethane feed in Sep. 13, 2022
033	Ethane Cracking Furnace #3		July 6, 2022	June 1, 2022, lit burners to start dry out. Ethane feed in Sep. 6, 2022
034	Ethane Cracking Furnace #4		July 6, 2022	August 17, 2022, lit burners to start dry out. Ethane feed in Sep. 17, 2022
035	Ethane Cracking Furnace #5		July 6, 2022	May 12, 2022, lit burners to start dry out. Ethane feed in Sep. 5, 2022
036	Ethane Cracking Furnace #6		July 6, 2022	May 6, 2022, lit burners to start dry out. Ethane feed in Sep. 25, 2022
037	Ethane Cracking Furnace #7		July 6, 2022	April 14, 2022, lit burners to start dry out. Ethane feed in Sep. 8, 2022
C031		SCR (Ethane Cracking Furnace #1)	August 15, 2022	August 15, 2022
C032		SCR (Ethane Cracking Furnace #2)	June 15, 2022	June 15, 2022
C033		SCR (Ethane Cracking Furnace #3)	June 19, 2022	June 19, 2022
C034		SCR (Ethane Cracking Furnace #4)	August 30, 2022	August 30, 2022
C035		SCR (Ethane Cracking Furnace #5)	May 22, 2022	May 22, 2022
C036		SCR (Ethane Cracking Furnace #6)	May 13, 2022	May 13, 2022
C037		SCR (Ethane Cracking Furnace #7)	April 22, 2022	April 22, 2022
101	Combustion Turbine/Duct Burner Unit #1		June 24, 2021	June 24, 2021
102	Combustion Turbine/Duct Burner Unit #2		June 20, 2021	June 20, 2021
103	Combustion Turbine/Duct Burner Unit #3		June 30, 2021	June 30, 2021
C101		SCR (Unit #1)	July 2021	Sep 2021
C101A		Oxidation Catalyst (Unit #1)	July 2021	Sep 2021
C102		SCR (Unit #2)	July 2021	August 2021
C102A		Oxidation Catalyst	July 2021	August 2021

Attachment B

List of Source(s) and/or Air Cleaning Devices Specified in Plan Approval No. 04-00740 A, B and C

Source ID	Source Name	Air Cleaning Device	Date of Completion	Operational Commencement Date
		(Unit #2)		
C103		SCR (Unit #3)	July 2021	Sep 2021
C103A		Oxidation Catalyst (Unit #3)	July 2021	Sep 2021
104	Cogeneration Plant Cooling Tower(s)		June 20, 2021	June 20, 2021
C104		Drift Eliminators (Process Cooling Tower)	June 20, 2021	June 20, 2021
105 <sup>a</sup>	Diesel-Fired Emergency Generator Engines (2)		March 2, 2020	March 2, 2020
106	Fire Pump Engines (2)		Dec 4, 2020	Dec 4, 2020,
107 <sup>a</sup>	Natural Gas-Fired Emergency Generators (3)		March 2, 2020	March 2, 2020
201	Ethylene Manufacturing Line		July 6, 2022	September 7 2022 feed into ECU
202 <sup>b</sup>	Polyethylene Manufacturing Lines		July 6, 2022	See Note b
C202 <sup>b</sup>		Particulate Filters (PE MFG)	July 6, 2022	See Note b
203	Process Cooling Tower(s)		July 6, 2022, including chemical cleaning and passivation activities	September 7 2022 feed into ECU
C203		Drift Eliminators (Process Cooling Tower)	July 6, 2022	September 7 2022 feed into ECU
204	Low Pressure (LP) Header System		May 16, 2022	May 16, 2022
C204		LP System	May 16, 2022	May 16, 2022
C204A		LP Incinerator	March 31, 2022. Lit for initial dry out	March 31, 2022
C204B		LP Multipoint Ground Flare (MPGF)	March 21, 2022. Lit pilots for testing	March 21, 2022
205	High Pressure (HP) Header System		May 12, 2022	May 12, 2022
C205		HP System	May 12, 2022	May 12, 2022
C205A		HP Ground Flare	March 16, 2022. Lit pilots for testing	March 16, 2022
C205B		HP Ground Flare	March 16, 2022. Lit pilots for testing	March 16, 2022
C205C		HP Elevated Flare	March 16, 2022. Lit pilots for testing	March 16, 2022
206	Spent Caustic Vent Header System		Construction completed, refractory dry out started May 18, 2022, re lit June 7, 2022 for operation	June 7, 2022

Attachment B

List of Source(s) and/or Air Cleaning Devices Specified in Plan Approval No. 04-00740 A, B and C

Source ID	Source Name	Air Cleaning Device	Date of Completion	Operational Commencement Date
C206		Spent Caustic Vent Incinerator	Construction completed, refractory dry out started May 18, 2022, re lit June 7, 2022 for operation	June 7, 2022
301	Polyethylene Pellet Material Storage/ Handling/Loadout		First pellet test run in PE3 March 19, 2022	March 19, 2022
C301		Fabric Filters (Pellet Storage/Handling/Loadout)	First pellet test run in PE3 March 19, 2022	March 19, 2022
302	Liquid Loadout (Recovered Oil)		July 6, 2022	May 24, 2023
303	Liquid Loadout (Pyrolysis Fuel Oil, Light Gasoline)		July 6, 2022	December 16, 2022 (PFO) March 21, 2023 (Light Gasoline)
304	Liquid Loadout (C3+)		July 6, 2022	September 9, 2022
305	Liquid Loadout (Coke Residue/Tar)		July 6, 2022	March 14, 2023 1 <sup>st</sup> load out of blended pitch from ECU
401	Storage Tanks (Recovered Oil, Equalizations Wastewater)		April 30, 2021	April 30, 2021
402	Storage Tank (Spent Caustic)		July 6, 2022	August 18, 2022
403	Storage Tanks (Light Gasoline)		July 6, 2022	February 3, 2022
404	Storage Tanks (Hexene)		May 31, 2022	May 31, 2022 (Tank B) and June 26, 2022 (Tank A)
405	Storage Tanks (Misc Pressurized/ Refrigerated)		May 12, 2022	5/12/2022
406	Storage Tanks (Diesel Fuel > 150 gallons)		December 4, 2020	December 4, 2020
C406 <sup>c</sup>		Carbon Canisters (Diesel Storage Tanks)	Construction has not commenced	See Note c
407	Storage Tanks (Pyrolysis Fuel Oil)		July 6, 2022	November 8, 2022
408	Storage Tanks (Diesel Fuel < 150 gallons)		March 2, 2020	March 2, 2020
409	Methanol Storage Vessels and Components		May 12, 2022	May 12, 2022
501 <sup>b</sup>	Equipment Components		July 6, 2022	First pellets made at PE3 November 21, 2022, last PE unit to start. All areas have LDAR

Attachment B

List of Source(s) and/or Air Cleaning Devices Specified in Plan Approval No. 04-00740 A, B and C

Source ID	Source Name	Air Cleaning Device	Date of Completion	Operational Commencement Date
502	Wastewater Treatment Plant		April 30, 2021	April 30, 2021
N/A	Induced Nitrogen Flootation Units covered under RfDs <ul style="list-style-type: none"> <li>• RfD 10119 Approval Date 4/10/2023</li> <li>• RfD 10277 Approval Date 8/9/2023</li> </ul>	Spent Caustic Vent Incinerator	Wemco INF: May 1, 2023 EC15 INF: November 19, 2023	Wemco INF: May 1, 2023 EC15 INF: November 19, 2023
503	Plant Roadways		Started paving in October 2020	Completed site paving June 5, 2023
504	SF6 High Voltage Switchgear		November 12, 2019	November 12, 2019

<sup>a</sup> Source 105, 107 engines covered by RfD 8259

<sup>b</sup> PE1 Unit commissioned on October 1, 2022. PE2 Unit commissioned on November 1, 2022. PE3 Unit initially attempted commissioning November 21, 2022, but has experienced equipment design deficiencies and was shut down since March 25, 2023, following limited commissioning attempts. PE3 Unit was re-commissioned and produced polyethylene on February 23, 2024.

<sup>c</sup> No applicable storage tank installed for requirement to apply