

Erosion and Sediment Control Plans Narrative

Atlantic Sunrise Project Phase 2

River Road Regulator Station
Drumore Township
Lancaster County
Pennsylvania

Prepared For:



Transcontinental Gas Pipe Line Company, LLC
2800 Post Oak Blvd
Houston, TX, 77251

Issued: August 2015
Revised: April 2017

BL Project No. 14C4909

Prepared By:

BL Companies
4242 Carlisle Pike, Suite 260
Camp Hill, PA 17011

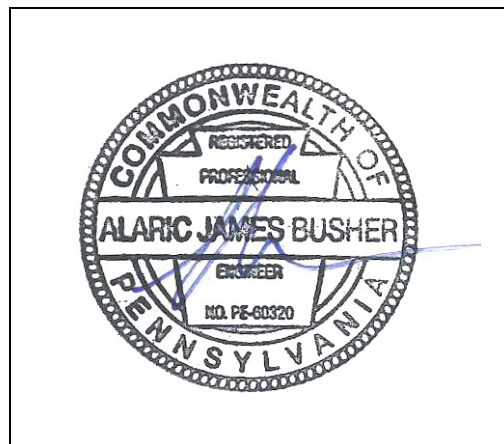

Alaric J Busher, PE
P.E. 60320

CONTENTS

<u>Part</u>	<u>Description</u>	<u>Page</u>
1.0	GENERAL INFORMATION	1
1.1	Topographic Features	
	USGS Site Location Map	2
	Aerial Location Map	3
1.2	Soil Characteristics	4
1.3	Earth Disturbance Activity	6
1.4	Project Site Runoff	8
1.5	Surface Water Classification	8
1.6	BMP Description Narrative.....	8
1.7	BMP Installation Sequence Narrative	10
1.8	Supporting Calculations and Measurements	14
1.9	Plan Drawings.....	14
1.10	Maintenance Program.....	14
1.11	Material Recycling and Disposal.....	15
1.12	Soil Conditions and Geologic Formations	20
1.13	Thermal Impacts	20
1.14	E&S Plan and PCSM/SR Plan Consistency.....	21
1.15	Riparian Forest Buffers	21
1.16	Antidegradation Requirements	21

APPENDICES

<u>Part</u>	<u>Description</u>
Appendix A	River Road Regulator Station Supporting Calculations
	A.1 Swale Calculations
	A.2 Sediment Barrier Table
	A.3 Supporting Information
Appendix B	Preparer Qualifications
Appendix C	Site Characterization Assessment

Appendix D

United States Department of Agriculture
(USDA) Natural Resources Conservation
Service (NRCS) Custom Soil Resource Report

1.0 GENERAL INFORMATION

The following narrative was prepared as a supplement to the Transcontinental Gas Pipe Line Company, LLC.'s (Transco's) Environmental Construction Plan (ECP) provided in Section 4 of the Erosion and Sediment Control General Permit 2 (ESCGP-2) Notice of Intent (NOI), which was prepared for the Atlantic Sunrise Project ("Project"). This E&SC narrative is intended to describe the erosion and sediment control design for the River Road Regulator Station ("Site") to be constructed as part of the Project, within Drumore Township, Lancaster County, Pennsylvania. Similar narratives were prepared, under separate cover, for facilities in other affected counties, as well as for the pipeline construction.

The facility proposed to be constructed as part of Phase 2 of the Atlantic Sunrise Project in Lancaster County is the following:

Facility Name	Facility Description	Facility Coordinates
River Road Regulator Station	Regulator Station	N39°50'09.68", W76°15'14.30"

The River Road Regulator Station will include the development of approximately 2.59 acres and the addition of 40,588 square feet of gravel area and a 2,860 square foot building. The River Road Regulator Station is adjacent to the Rock Springs Expansion Project. The Rock Springs Expansion Project was designed by others and covered under a separate permit. The Site will utilize existing public and private roads for access to the Site during and after construction. Best Management Practices (BMPs), in accordance with the standards and specifications in the Pennsylvania Department of Environmental Protection's (PADEP's) "Erosion and Sediment Pollution Control (E&S) Program Manual," Technical Guidance No. 363-2134-008, as amended and updated (E&S Manual) will be used during all phases of construction.

Refer to the ECP (**Section 4 of the ESCGP-2 NOI**) for overall Project information.

There are no impacts to regulated wetlands associated with this proposed Site. Refer to the Wetland Delineation Report provided in **Section 5 of the ESCGP-2 NOI** for information supporting wetland mapping as shown on the Erosion and Sediment Control (E&SC) Plans (**Section 2 of the ESCGP-2 NOI**).

1.1 Topographic Features

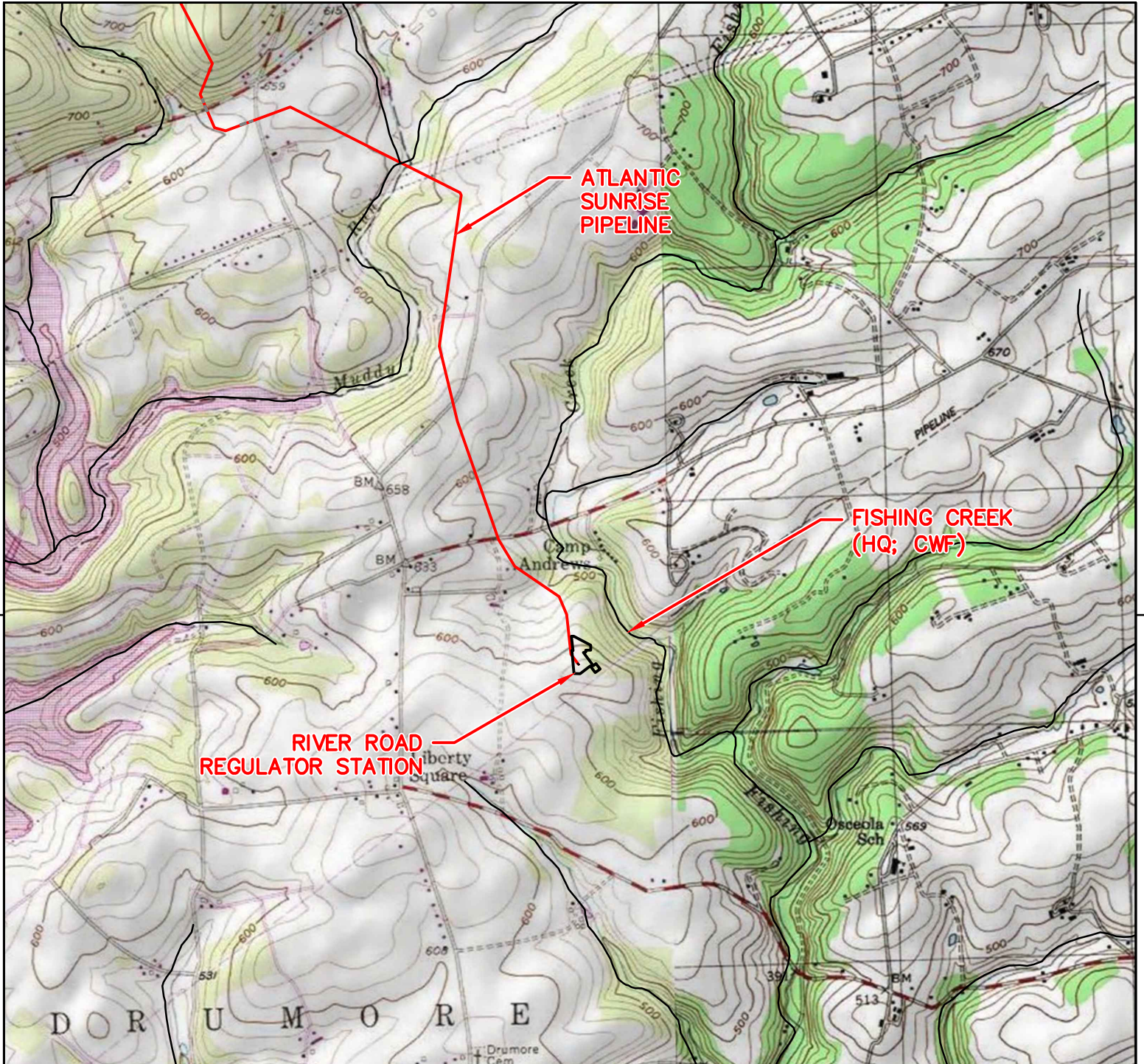

2013 USGS HOLTWOOD QUADRANGLE

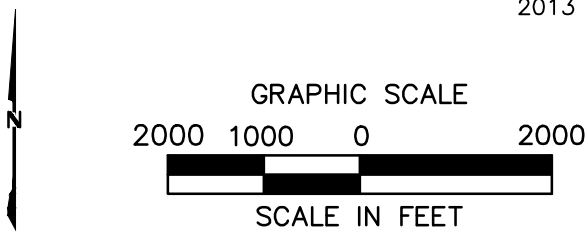

ATLANTIC SUNRISE PROJECT
RIVER ROAD REGULATOR STATION
USGS LOCATION MAP
DRUMORE TOWNSHIP
LANCASTER COUNTY, PENNSYLVANIA



NO.	DATE	BY	REVISION DESCRIPTION	W.O. NO.	CHK.	APP.	DRAWN BY:	DATE:	ISSUED FOR BID:	SCALE:
0	08-28-15	BL	ISSUED FOR PADEP PERMIT SUBMITTAL	1161509	SMK		JEC	04/03/15		1"=2,000'
1	12-02-15	BL	ISSUED FOR PADEP RESUBMITTAL	1161509	AJB			04/03/15		
2	10-17-16	BL	PADEP TECHNICAL DEFICIENCY RESPONSE #1	1161903	AJB			04/03/15		
							WO:	1161509	DRAWING NUMBER:	RIVER ROAD RS LOCATION
									ISSUED FOR CONSTRUCTION:	SHEET 1 OF 1

1.2 Soil Characteristics

In addition to the below use limitations and resolutions, refer to Appendix D for the United States Department of Agriculture (USDA) Natural Resources Conservation Service (NRCS) Custom Soil Resource Report for the Site.

Soil Type and Use Limitations

Map Symbol	Soil Name	Slope	Cut Banks Cave	Corrosive to Concrete or Steel	Droughty	Easily Erodible	Flooding	High Water Table	Hydric/Hydric Inclusions	Low Strength	Slow Percolation	Piping	Poor Source of Topsoil	Frost Action	Shrink-Swell	Potential Sinkhole	Ponding	Wetness
CbB	Chester silt loam	3-8%	X	C		X				X		X		X				
GbB	Glenelg silt loam	3-8%	X	C		X			X	X	X	X	X	X				X
GbC	Glenelg silt loam	8-15%	X	C		X			X	X	X	X	X	X				X
MbD	Manor very stony silt loam	8-25%	X	C		X				X	X	X	X	X				

Source: Appendix E, Table E-1, PADEP, *Erosion and Sediment Pollution Control (E&S) Program Manual* Technical Guidance Number 363-2134-008.

Soil Use Limitations Resolutions

Limitation	Resolution
Cut Banks Cave	Excavations will be properly supported by sheeting and shoring to prevent caves.
Corrosive to Concrete or Steel	No concrete or steel piping is proposed without appropriate coatings and protection.
Droughty	Existing suitable topsoil and soil amendments will be used during construction.
Easily Erodible	Temporary and permanent erosion control BMPs will be employed throughout the Site.
Flooding	Ensure that the Site has proper drainage.
High Water Table	A geotechnical investigation was conducted to minimize conflicts with saturated zones.
Hydric/Hydric Inclusions	A wetland investigation was completed to determine no wetlands are present in the development area.
Low Strength	A maximum of 3:1 slopes are proposed.
Slow Percolation	A field investigation of percolation rates at the infiltration areas was performed to verify the soils percolation capacity.
Piping	Watertight pipe, antiseep collars, clay cores through basin berms, and concrete endwalls will be used to minimize the danger of piping.
Poor Source of Topsoil	Existing topsoil, which has proven to be suitable, will be reused on the Site.
Frost Action	Pavement subbase will be provided to minimize frost effects.
Shrink-Swell	Stone base will be provided to prevent shrink-swell from effecting pavement.
Potential Sinkhole	Geotechnical engineer of record recommendations will be followed for any potential occurrences.
Ponding	Surface grading and drainage facilities will be provided to minimize ponding affects.
Wetness	Wet weather construction recommendations, per the geotechnical engineer's recommendations, will be employed to minimize the effects of wetness during construction, surface grading. Surface grading and drainage will be provided to minimize wetness affects after construction.

1.3 Earth Disturbance Activity

Proposed Improvements and Land Use

The proposed River Road Regulator Station will be constructed in Drumore Township, Lancaster County, Pennsylvania. River Road Regulator Station will include construction of a regulator station. The earthmoving activity will involve the stripping and stockpiling of top soil, Site grading, Site excavation, placement of fill, trenching and backfill, construction of equipment with gravel pad/parking lot, construction of a gravel access drive, construction of a stormwater management system, finish grading, and stabilization of disturbed surfaces.

Present/Past Land Use

This section identifies the land requirements for construction and operation of the proposed facility. Table 1.3.1 summarizes the land requirements for the proposed River Road Regulator Station associated with the CPL South mainline.

The present characterization of land use within the proposed facility project areas is based on interpretation of aerial photographs taken in the spring of 2014 and information gathered from field surveys conducted during 2014 and 2015. The adjacent area to the east of the proposed facility project area is occupied by the Rock Springs facility built in 2016. Previous land uses in the last 5 to 50 years within the project area have remained similar to present use. Transco classified land uses within the proposed project areas into the following eight broad types:

- Agricultural Land – land associated with active cultivation of row and field crops; areas of grasses planted for livestock grazing or for the production of hay crops; orchards; and specialty crops, including vineyards, Christmas trees, and fruits and vegetables.
- Upland Forest/Woodland – includes upland deciduous forest, evergreen forest, and mixed (deciduous and evergreen) forest, but does not include forested wetlands.
- Industrial/Commercial Land – land used for mines or quarries and associated processing plants; manufacturing or other industrial facilities; and land developed for commercial or retail uses, including malls, strip plazas, business parks, and medical facilities.
- Transportation Land – land used for transportation purposes, including interstate highways; state, county, and local highways and roads; and railroad lines.

- Residential Land – residential areas, including yards of individual residences.
- Open Land – non-forested and undeveloped land not classified for another use, including land maintained as utility ROWs for overhead and underground electric transmission, natural gas transmission, and oil transmission facilities.
- Wetlands – includes wetlands covered with emergent, scrub-shrub, and forested vegetation.
- Open Water – include rivers, streams, creeks, canals, and other linear waterbodies, as well as lakes, ponds, and other non-flowing waterbodies.

New Main Line Valve sites (MLVs) will be wholly located within the permanent ROWs for the proposed CPL North and CPL South mainlines or permanent facilities. Construction will primarily occur within the proposed CPL North and CPL South construction ROWs.

**Table 1.3.1
Land Requirements for the New Aboveground Facilities^a**

Facility	Milepost	County	Agricultural Land (acres)		Upland Forest / Woodland (acres)		Open Land (acres)		Total (acres)	
			Cons	Op	Cons	Op	Cons	Op	Cons	Op
River Road Regulator Station with pig receiver	Transco Mainline 1683.3	Lancaster	0.0	0.0	2.1	2.1	0.3	0.3	2.4	2.4
Lancaster County Subtotal			0.0	0.0	2.1	2.1	0.3	0.3	2.4	2.4
Notes: ^a Land use acreages for construction and operation are provided for reference only. Acreages provided were calculated by using kmz files and prepared as part of the June 8, 2015 FERC Supplement. Refer to plans and ESCGP-2 NOI for actual site conditions. Key: Cons = Construction L = Leidy Line system milepost Op = Operation										

Recently, the Rock Springs Expansion project constructed a facility and access road on the same parcel. This work was completed under a separate permit. The proposed River Road facility will utilize the Rock Springs Expansion access road for permanent

access. This erosion control design is meant to address construction of the new River Road Regulator Station only.

1.4 Project Site Runoff

Runoff rate calculations have been performed for the Site and its upstream watershed area.

Runoff Rate Summary Table

STORM EVENT	PRE-DEVELOPMENT PEAK FLOW (CFS)	POST-DEVELOPMENT PEAK FLOW (CFS)	REDUCTION (CFS)
1-yr	0.20	0.03	0.17
2-yr	0.62	0.09	0.53
5-yr	1.93	0.33	1.60
10-yr	3.18	0.63	2.55
25-yr	5.06	1.71	3.35
50-yr	6.61	2.79	3.82
100-yr	8.24	4.22	4.02

*See the PCSM/SR Narrative for additional rate and volume calculations, as provided in Appendix A, of the PCSM/SR Narrative.

1.5 Surface Water Classification

The E&SC drawings in **Section 2 of the ESCGP-2 NOI** depict the locations of the streams and wetlands in and near the LOD for the Site. The Site area surface water runoff drains to Fishing Creek. The receiving water is designated as High Quality, Cold Water Fishery (HQ-CWF) under PA Code 25 Chapter 93. The Site's watershed is listed as impaired but not impaired by siltation and not requiring a TMDL in the **2016 Integrated Water Quality Report**.

1.6 BMP Description Narrative

E&SC BMPs, consistent with the PADEP E&S Manual are planned to be used at the Site before, during, and after earth disturbance activities. Perimeter and onsite E&SC BMPs will be installed prior to any disturbance of areas tributary to the E&SC BMPs. Installation and maintenance guidelines, as well as E&SC BMP locations are as shown on the E&SC Plans and Detail Sheets (**Section 2 of the ESCGP-2 NOI**). The E&SC BMPs that will be used on River Road Regulator Station include the following:

Temporary E&SC BMPs

- **Rock Construction Entrances w/ Wash Racks:** A Rock Construction Entrance (RCE) with wash rack is a method of stabilizing a temporary construction entrance to a Project site from a paved roadway by placement of AASHTO #1 stone. RCEs will be placed at all entrances to the Project area. The wash rack is required on the CPL North, CPL South, and Associated Facilities where indicated to remove excessive tracking of mud onto a roadway.
- **Vacuum Sweeping:** ***Vacuum Sweeping may be used to mitigate the spread of sediment beyond the RCEs. RCEs will be inspected daily for sediment tracking onto public roadways. If sediment is observed in the cartway, the roadway shall be vacuum swept within 24 hours, or as soon as feasible. All vehicles leaving the RCE shall be inspected for large clumps of debris. If debris, larger than 4" diameter is observed, it shall be manually removed from the vehicle. Dirt roads shall be inspected weekly for rutting. If rutting in excess of 4" is observed, the road shall be rolled as soon as feasible. Dump trucks hauling material from RCEs in special protection watersheds will be covered with a tarpaulin.***
- **Rock Filter Outlets:** Rock Filter Outlets (RFOs) may be used to control runoff; they may also be used below construction work while flow is being diverted past the work area. RFOs may be used to control sediment either during construction or during temporary disturbance. RFOs should be constructed according to the specifications shown in the Standard Detail Sheets. RFOs should be inspected weekly and needed repairs should be initiated within 72 hours after inspection. Anchored compost layer shall be used on upslope face in HQ and EV watersheds.
- **Pumped Water Filter Bag:** Sediment laden water that collects during excavation is required to be pumped from the excavation and shall be treated in a sediment pumped water filter bag. The Contractor and Environmental Inspector will dictate the location and placement of the bag. The Contractor and Environmental Inspector must meet PADEP requirements and the manufacturer's recommendations for use.
- **Compost Filter Sock:** Compost Filter Sock (CFS) is a sediment barrier consisting of a mesh sock and coarse compost. CFS will be placed to control runoff and collect sedimentation. CFS is Antidegradation Best Available Combination of Technologies (ABACT) for HQ and EV watersheds.

- Orange Construction Fence: Orange construction fence shall be installed at the limits of all stormwater management facilities to be protected from construction vehicle access. Upon Site stabilization or conversion of stormwater management facilities to permanent conditions, the fences shall be removed.
- Erosion Control Blanket: Erosion Control Blanket (ECB) is a soil covering made from straw, coir, excelsior, or synthetic material used to minimize the potential for erosion of an exposed soil until a suitable vegetative cover can be established. It will be placed in the Project area within 50 feet of streams and wetlands, as well as in the Site area where a slope of 3:1 or greater exists (unless located in an agricultural area).
- Hydraulically Applied Erosion Control Blanket: A Hydraulically Applied ECB is Bonded Fiber Matrix (BFM) that can be used in place of ECBs where necessary. For slopes up to 3H:1V, the BFM will be applied at a rate of 3,000 pounds per acre. Slopes steeper than 3H:1V will need to be applied at a rate of 4,000 pounds per acre. In any case, manufacturer's recommendations should be followed.
- Temporary Vegetative Stabilization: Upon temporary cessation of an earth disturbance activity or any stage or phase of an activity where cessation of earth disturbance activities will exceed four days, the Site shall be immediately seeded, mulched, or otherwise protected from accelerated erosion.

Permanent E&SC BMPs

- Riprap Aprons / Outlet Protection: Outlet Protection shall be installed as shown on Plan Drawings and according to the Standard Detail Sheets. Outlet Protection will help dissipate energy from flow concentrated through culverts.
- Permanent Vegetative Stabilization: Upon reaching final grades, and upon cessation of earth disturbance activities, disturbed areas will receive topsoil, seed, and mulch to establish permanent vegetative stabilization.

1.7 BMP Installation Sequence Narrative

Refer to the E&SC Plans (as provided in **Section 2 of the ESCGP-2 NOI**) for the location of the proposed work and the associated E&SC BMPs. Necessary parts for proper and complete execution of work pertaining to this sequence, whether specifically mentioned or not, are to be performed by the Contractor. It is not intended that the drawings and this E&SC narrative show every detailed piece of material or equipment. The Contractor shall comply with all requirements listed in this Section 1.7. The

Contractor may be required to alter controls based on effectiveness of controls or differing conditions encountered in the field.

1. At least 7 days prior to starting any earth disturbance activities, including clearing and grubbing, the owner and/or operator shall invite all contractors, Environmental Inspectors, the landowner, appropriate municipal officials, the E&E plan preparer, the PCSM plan preparer, the licensed professional responsible for oversight of critical stages of implementation of the PCSM plan, and a representative from the local conservation district to an on-site preconstruction meeting.
2. At least 3 days prior to starting any earth disturbance activities, or expanding into an area previously unmarked, the Pennsylvania One Call System Inc. shall be notified at 1-800-242-1776 for the location of existing underground utilities.
3. Hold pre-construction conference with the Permittee(s), Co-Permittee(s), Operators, Environmental Inspectors, local County Conservation District (CCD), PADEP, and licensed professionals or designees responsible for the earth disturbance activity, including implementation of the E&S and PCSM plans and critical stages of implementation of the approved PCSM plan.
4. Install orange construction fence around areas to be protected. Protected woodland areas shall be clearly delineated in the field prior to any construction activities. Protected areas should not be disturbed during construction except for temporary impacts for mitigation or restoration efforts.
5. Locate staging areas and access points including construction entrances. Field locate limits of disturbance.
6. Install rock construction entrances (RCEs).
7. Remove brush to effectively install perimeter controls as shown on the construction drawings.
8. The Compliance Manager shall provide PADEP and CCD at least three days' notice prior to bulk earth disturbance and upon completed installation of perimeter erosion controls.
9. ***Install the following BMPs:**
 - 9.1. **Install infiltration basins, including clay core, antiseep collars, slope liners, inlet and outlet piping including inlet I-1, emergency spillway, vegetated swale and associated improvements. Excavate basin bottom to finished grades. Do not install engineered soil at this time.**

9.2. Install orange construction fence at perimeter of infiltration basin to prevent compaction of basin bottoms.

10. Begin grading and strip and stockpile topsoil within the regulator station area and install sediment barriers around stockpile.
11. Upon temporary cessation of an earth disturbance activity or any stage of an activity where the cessation of earth disturbance activities will exceed four days, the site shall be immediately seeded, mulched, or otherwise protected from accelerated erosion and sedimentation pending future earth disturbance activities. For an earth disturbance activity or any stage of an activity to be considered temporarily stabilized, the disturbed areas shall be covered with one of the following: a minimum uniform coverage of mulch and seed, with a density capable of resisting accelerated erosion and sedimentation, or an acceptable BMP which temporarily minimizes accelerated erosion and sedimentation. Temporary stabilization will not occur on active vehicular travel ways within the row. The on-site environmental inspector will log daily activity within the LOD and notify the Contractor of areas requiring temporary stabilization (i.e., areas where work has ceased for at least four days).
12. Rough grade Site.
13. Grade the regulator station pad and portion of access road to be reconstructed, including stone swale 1 as shown on the E&SC and PCSM/SR plans (**Sections 2 and 3 of the ESCGP-2 NOI**). Install inlet protection on inlet I-1 to prevent siltation of basin.
14. Immediately stabilize side slopes with erosion control matting when slopes are 3:1 or greater. See PCSM/SR plans and detail sheets, as provided in **Section 3 of the ESCGP-2 NOI**, (patterns differ by slope category). Install rip rap slope stabilization where shown on the PCSM/SR plans.
15. Establish final grade.
16. Surface stabilization, apply permanent stabilization measures including gravel pad, fertilizer, seed, mulch and erosion control blankets immediately to any disturbed areas where work has reached final grade. Seed mixtures, fertilizer and mulch applications rates and dates shall conform to the tables provided on the PCSM/SR plans and detail sheets (**Section 3 of the ESCGP-2 NOI**), land owner agreements and/or the ECP (**Section 4 of the ESCGP-2 NOI**). After seeding, fertilizing and mulching is complete, install erosion control blankets as required or ordered on slopes of 3:1 or greater.

17. ***Upon stabilization of gravel pad, remove 18" of soil from basin bottom and install engineered soil in infiltration basin bottoms. Immediately seed and mulch. Complete infiltration testing on material after placement and hand compaction. Perform additional testing 60 days following placement. If infiltration rates are outside specified range of 0.50in/hr to 3.33in/hr, aerate or compact material as needed to adjust infiltration rate. Install silt sock at interior toe of slope to minimize siltation of basin bottoms. Install silt sock 5 and 10 upslope to protect infiltration basins from siltation.**
 18. Upon completion of all earthwork activities and permanent stabilization of all disturbed areas, the Owner and/or Operators shall contact the local CCD for an inspection prior to the removal of the E&SC BMPs.
 19. After all upslope disturbed areas are stabilized, remove temporary inlet protection and allow flow to inlet I-1. Remove rock construction entrance. Restore existing gravel road.
 20. After the site is permanently stabilized and upon PADEP or local CCD and Owner approval of stabilization and re-vegetation, remove temporary erosion and sediment control measures and stabilize areas disturbed by removal.
 21. Complete site stabilization in areas of BMP removal, including fertilizing, seed application, erosion control blanket and mulching.
 22. Upon completion of all earth disturbance activities and permanent stabilization of all disturbed areas, the Owner and/or Operators shall contact the local CCD for a final inspection.
 23. Maintain E&SC BMPs until site work is complete and uniform 70% perennial vegetative cover is established.
 24. Remove and properly dispose/recycle E&SC BMPs. Remove orange construction fence. repair and permanently stabilize areas disturbed during E&SC BMP removal upon establishment of uniform 70% vegetative cover.
- * indicates a critical stage of PCSM installation to be observed by a licensed professional or designee. Contractor to provide three working days' notice to Design Engineer.**

1.8 Supporting Calculations and Measurements

Supporting calculations are provided in Appendix A.

1.9 Plan Drawings

E&SC Plan Drawings are included in **Section 2 of the ESCGP-2 NOI**.

1.10 Maintenance Program

E&SC BMPs shall be maintained properly throughout the construction of the Site. The following inspection and maintenance shall be implemented to maintain E&SC BMPs.

- Maintenance and inspection of E&SC BMPs shall conform to the following:
 - Federal Energy Regulatory Commission (FERC) regulations, Attachment 17 of the **ECP** as provided in **Section 4 of the ESCGP-2 NOI**;
 - Transco's Project-specific Upland Erosion Control, Revegetation, and Maintenance Plan (Transco Plan) included as **Attachment 17 of the ECP** as provided in **Section 4 of the ESCGP-2 NOI**;
 - Transco's Project-specific Wetland and Waterbody Construction and Mitigation Procedures, and Procedures (Transco Procedures) included as **Attachment 18 of the ECP** as provided in **Section 4 of the ESCGP-2 NOI**; and
 - PA Code Chapter 102 and 105 regulations, including all conditions of the ESCGP-2.
- Until the Site is stabilized, all E&SC BMPs shall be maintained properly. Maintenance shall include inspections of all E&SC BMPs after each runoff event and on a weekly basis. All preventative and remedial maintenance work, including clean out, repair, replacement, regrading, reseeding, remulching and renetting must be initiated immediately. If the E&SC BMPs fail to perform as expected, replacement E&SC BMPs, or modifications of those installed will be required.
- Immediately upon discovering unforeseen circumstances posing the potential for accelerated erosion and/or sediment pollution, the Operator shall implement appropriate E&SC BMPs to minimize the potential for erosion and sediment pollution and notify the local CCD and/or the regional office of the PADEP.
- A log showing dates that E&SC BMPs were inspected as well as any deficiencies found and the date they were corrected shall be maintained with the Environmental Inspector's records on the Site and be made available to regulatory agency officials at the time of inspection.

- The reviewing agency (PADEP or local CCD) shall be notified of any changes to the approved E&SC Plan prior to implementation of those changes. The reviewing agency may require a written submittal of those changes for review and approval at its discretion.
- Refer to E&SC BMP Detail Sheets for inspection and maintenance procedures specific to each E&SC BMP (See **Section 2 of the ESCGP-2 NOI**).
- Sediment removed from E&SC BMPs shall be properly disposed of off-site or placed on-site up gradient of E&SC BMPs.
- All Site entrance and exit points will be inspected on a daily basis for evidence of off-site tracking of mud. The Contractor shall clean streets and roads of mud and/or dust and keep the streets and roads in a clean and dust-free condition.
- Access road gravel thickness shall be constantly maintained. A stockpile shall be maintained on-site for this purpose.
- E&SC BMPs shall remain functional as such until all areas tributary to them are permanently stabilized or until they are replaced by another E&SC BMP approved by the local CCD or PADEP.
- Permanent stabilization is defined as a minimum uniform, perennial 70 percent vegetative cover or other permanent non-vegetative cover with a density sufficient to resist accelerated erosion. Cut and fill slopes shall be capable of resisting failure due to slumping, sliding, or other movements. Any area not achieving a minimum uniform 70 percent perennial vegetative cover shall be reseeded and mulched within 24 hours of detection.

1.11 Material Recycling and Disposal

Transco has prepared a Spill Plan for Oil and Hazardous Materials to assist in prevention of any spills that may occur during the Project and to respond to any spills that do occur. The Contractor will be required to become familiar with the Spill Plan for Oil and Hazardous Materials and its contents prior to commencing any construction-related activities. The Spill Plan for Oil and Hazardous Materials is included as Attachment 9 to the ECP provided as **Section 4 of the ESCGP-2 NOI**. The Spill plan will be available on-site as the Preparedness, Prevention, and Contingency (PPC) Plan.

The Contractors are required to inventory and manage their construction on-site materials. The goal is to be aware of the materials on-site, ensure they are properly

maintained, used, and disposed of, and to make sure the materials are not exposed to stormwater.

Materials Covered

The following materials or substances are expected to be present on-site during construction (**Note: this list is not an all-inclusive list and the Materials Management Practices can be modified to address additional materials used on-site**):

- Acids
- Detergents
- Fertilizers (nitrogen/phosphorus)
- Hydroseeding mixtures
- Petroleum based products
- Sanitary wastes
- Soil stabilization additives
- Solder
- Solvents
- Other (list here): _____

These materials must be stored as appropriate and shall not contact storm or non-stormwater discharges. Contractor shall provide a weather proof container to store chemicals or erodible substances that must be kept on the Site. Contractor is responsible for reading, maintaining, and making employees and subcontractors aware of safety data sheets (SDSs).

Material Management Practices

The following are material management practices that will be used to reduce the risk of spills or other accidental exposure of materials and substances to stormwater runoff.

1. Good Housekeeping Practices

The following good housekeeping practices will be followed on Site during construction:

- Store only enough material required to do the job.
- Store materials in a neat, orderly manner.

- Store chemicals in watertight containers or in a storage shed, under a roof, completely enclosed, with appropriate secondary containment to prevent spill or leakage. Drip pans shall be provided under dispensers.
- Substances will not be mixed with one another unless recommended by the Manufacturer.
- Manufacturer's recommendations for proper use and disposal will be followed.
- Inspections will be performed to ensure proper use and disposal of materials.
- Cover and berm loose stockpiled construction materials that are not actively being used (i.e. Soil, spoils, aggregate, etc.).
- Minimize exposure of construction materials to precipitation.
- Minimize the potential for off-site tracking of loose construction and landscape materials.

2. Hazardous Products

These practices will be used to reduce the risks associated with hazardous materials. SDSs for each substance with hazardous properties that is used on the job site(s) will be obtained and used for the proper management of potential wastes that may result from these products. A SDS will be posted in the immediate area where such product is stored and/or used and another copy of each SDS will be maintained in a file at the job site construction trailer office. Each employee, who must handle a substance with hazardous properties, will be instructed on the use of SDS and the specific information in the applicable SDS for the product he/she is using, particularly regarding spill control techniques.

- Products will be kept in original containers with the original labels in legible condition.
- Original labels and SDSs will be produced and used for each material.
- If surplus product must be disposed of, manufacturers or local/state/federal recommended methods for proper disposal will be followed.

3. Hazardous Wastes

All hazardous waste materials will be disposed of by the Contractor in the manner specified by local, state, and/or federal regulations and by the manufacturer of such products. Site personnel will be instructed.

4. Concrete and Other Wash Waters

Prevent disposal of rinse, wash waters, or materials on impervious or pervious surfaces, into streams, wetlands or other water bodies.

Concrete trucks will be allowed to wash out or discharge surplus concrete or drum wash water on the Site, but only in either (1) specifically designated diked areas which have been prepared to prevent contact between the concrete and/or washout and soil and stormwater having the potential to be discharged from the Site; or (2) in locations where waste concrete can be poured into forms to make riprap or other useful concrete products.

The hardened residue from the concrete washout diked areas will be disposed of in the same manner as other non-hazardous construction waste materials or may be broken up and used on the Site as deemed appropriate by the Contractor and Owner or Owner's representative. The Contractor will be responsible for seeing that these procedures are followed.

All concrete washout areas will be located in an area where the likelihood of the area contributing to stormwater discharge is negligible. If required, additional E&SC BMPs must be implemented to prevent concrete wastes from contributing to stormwater discharges. The location of the concrete washout area(s) must be identified, by the Contractor/Job Site Superintendent, on the job site copy of the E&SC Plans (**Section 2 of the ESCGP-2 NOI**) and in this E&SC Narrative.

5. Sanitary Wastes

All sanitary waste units will be located in an area where the likelihood of the unit contributing to stormwater discharges is negligible. Additional E&SC BMPs must be implemented, such as containment trays (provided by the rental company) or special containment created with 2" x 4" lumber, impervious plastic, and gravel. The location of the sanitary waste units must be identified on the job site copy of the E&SC Plans (**Section 2 of the ESCGP-2 NOI**), in this E&SC Narrative, by the Contractor/Job Site Superintendent.

6. Solid and Construction Wastes

All waste materials will be collected and stored in a securely lidded metal dumpster. The dumpster will comply with all local and state solid waste management regulations. The dumpster/container lids shall be closed at the end of every business day and during rain events. Appropriate measures shall be taken to prevent discharges from waste disposal containers to the receiving water.

7. Construction Access

A stabilized construction exit will be provided to help reduce vehicle tracking of sediments. The paved roads adjacent to the Site entrance will be inspected daily and swept as necessary to remove any excess mud, dirt, or rock tracked from the Site. Dump trucks hauling material from the construction site will be covered with a tarpaulin as necessary.

8. Petroleum Products

On-site vehicles will be monitored for leaks and receive regular preventative maintenance. Petroleum products will be stored in tightly sealed containers which are clearly labeled. Petroleum storage tanks on-site will have a dike or berm containment structure constructed around it to contain spills which may occur (containment volume to be 110% of volume stored). The dike or bermed area shall be lined with an impervious material such as a heavy duty plastic sheet. Drip pans shall be provided for all dispensers. Any asphalt substances used on the Site will be applied according to the manufacturer's recommendations.

9. Fertilizers and Landscape Materials

Fertilizers will be applied only in the minimum amounts recommended by the manufacturer. Once applied, fertilizer will be worked into the soil to minimize the potential for exposure to stormwater. Storage will be under cover. The contents of any partially used bags of fertilizer will be transferred to a sealable plastic bin to minimize the potential for spills. The bin shall be labeled appropriately.

Contain stockpiled materials, such as but not limited to, mulches, top soil, rocks and gravel, and decomposed granite, when they are not actively being used.

Apply erodible landscape material at quantities and application rates according to the manufacturer's recommendations or based on written specifications by knowledgeable and experienced field personnel. Discontinue the application of

any erodible landscape material within two days prior to a forecasted rain event or during periods of precipitation.

10. Paints, Paint Solvents and Cleaning Solvents

Containers will be tightly sealed and stored when not in use. Excess paint and solvents will be properly disposed of according to the manufacturer's recommendations or local, state, and/or federal regulations.

11. Contaminated Soils

Any contaminated soils (resulting from spills of materials with hazardous properties) which may result from construction activities will be contained and cleaned up immediately in accordance with applicable local, state and federal regulations.

1.12 Soil Conditions and Geologic Formations

There are no naturally occurring geologic formations or soils on-site that are expected to have the potential to cause pollution during earth disturbance activities. See E&SC Detail Sheets (**Section 2 of the ESCGP-2 NOI**) for Acid-Producing Soils and Bedrock Control Plan should any unexpected acid runoff producing soils or geologic formations be encountered.

1.13 Thermal Impacts

Thermal impacts associated with CPL North, CPL South, and Associated Facilities will be avoided to the maximum extent practicable. The following provisions related to thermal impacts are included in the **E&SC Plan** within **Section 2 of the ESCGP-2 NOI**:

- The minimum permanent changes in land cover, necessary to construct the required facilities are being proposed.
- Runoff from the permanent impervious areas will be collected as part of the Post Construction Stormwater Management/Site Restoration (PCSM/SR) Plan and routed to PCSM/SR BMPs. In addition, impervious areas will be gravel instead of asphalt wherever practical.
- PCSM/SR BMPs incorporate the use of infiltration basins.

- The removal of vegetation, especially tree cover, will be limited to only that necessary for construction.
- The amount of impervious surfaces will be limited to only that necessary to support the construction of CPL North, CPL South, and Associated Facilities and/or operation of the pipeline.
- Site disturbance is approximately 550' from the nearest receiving water. Runoff will be through an existing conveyance channel or via overland flow through a wooded area. The combination of travel length and tree canopy is expected to negate any thermal impacts the site will have on the receiving waters.

1.14 E&S Plan and PCSM/SR Plan Consistency

The E&S Plans and Narrative have been designed and will be constructed to be consistent with the PCSM/SR Plans. Following completion of construction, disturbed areas shall be stabilized and the long-term maintenance of the PCSM/SR BMPs will begin.

1.15 Riparian Forest Buffers

There are no regulated riparian buffers within the Site area.

1.16 Antidegradation Requirements

The Project is in a special protection watershed that is not siltation impaired and has no TMDL identified. Therefore, the following non-discharge BMPs will be utilized prior to, during and after earth disturbance activities:

Alternative Siting/Alternative Location: The proposed location was chosen in an attempt to minimize impacts to wetland and streams and wooded areas. Within the limitations of landscape and landowner constraints, the facility was located in areas where wetland and/or stream avoidance was possible. The Project is located along an existing pipeline and adjacent to a proposed facility of similar use. Minimal additional clearing of wooded areas is proposed for the Project. No regulated riparian buffers are impacted by the facility LOD.

Limited Disturbed Area: The limit of disturbance was minimized to the fullest extent practicable to avoid increased erosion and sediment issues. The Project will be located in an area already disturbed by the Rock Springs Expansion Project, thereby minimizing any tree removal or disturbance of established vegetation.

Limiting Extent & Duration of Disturbance: As construction progresses, completed areas will be final graded and permanently stabilized. In all areas where construction becomes inactive, temporary stabilization will occur immediately.

ABACT BMPs are proposed for the site during construction. Use of ABACT erosion and sediment control BMPs will minimize sedimentation of the downstream receiving waters.

Post Construction Stormwater management (PCSM) BMPs are proposed to provide a post construction infiltration volume that exceeds the predeveloped infiltration volume of the site. Stormwater runoff rates will also be managed in the PCSM BMPs. Post developed runoff rates will not exceed predeveloped runoff rates. Post construction runoff will be via overland flow or over energy dissipating rip rap aprons to prevent physical degradation of the receiving waters.

APPENDICES

Appendix A	River Road Regulator Station Supporting Calculations
	A.1 Swale Calculations
	A.2 Sediment Barrier Table
	A.3 Supporting Information
Appendix B	Preparer Qualifications
Appendix C	Site Characterization Assessment
Appendix D	United States Department of Agriculture (USDA) Natural Resources Conservation Service (NRCS) Custom Soil Resource Report

APPENDIX A

River Road Regulator Station Supporting Calculations

- A.1 Swale Calculations
- A.2 Sediment Barrier Table
- A.3 Supporting Information

A.1 Swale Calculations

E&S WORKSHEET # 11

Channel Design Data

PROJECT NAME: ATLANTIC SUNRISE PROJECT - RIVER ROAD REGULATOR STATION

LOCATION: DRUMORE TOWNSHIP, LANCASTER COUNTY, PENNSYLVANIA

PREPARED BY: JEC DATE: 07/21/2016

CHECKED BY: AJB DATE: 07/21/2016

CHANNEL OR CHANNEL SECTION	STONE SWALE 1 LINING	VEG SWALE		
TEMPORARY OR PERMANENT? (T OR P)	P	P		
DESIGN STORM (2, 5, OR 10 YR)	10	10		
ACRES (AC)	0.86	1.99		
MULTIPLIER ¹ (1.6, 2.25, or 2.75) ¹	2.75	2.75		
Q _r (REQUIRED CAPACITY) (CFS)	2.37	3.41	Use 100 year from HydroCAD	
Q (CALCULATED AT FLOW DEPTH d) (CFS)	2.31	3.42		
PROTECTIVE LINING ²	R-3	SC150/GRASS		
n (MANNING'S COEFFICIENT) ²	0.032	0.049		
V _a (ALLOWABLE VELOCITY) (FPS)	N/A	N/A		
V (CALCULATED AT FLOW DEPTH d) (FPS)	2.06	1.70		
τ _a (MAX ALLOWABLE SHEAR STRESS) (LB/FT ²)	1.00	1.00		
τ _d (CALC'D SHEAR STRESS AT FLOW DEPTH d) (LB/FT ²)	0.25	0.41		
CHANNEL BOTTOM WIDTH (FT)	2	2		
CHANNEL SIDE SLOPES (H:V)	2	3		
D (TOTAL DEPTH) (FT)	1.0	1.0		
CHANNEL TOP WIDTH @ D (FT)	6	8		
d (CALCULATED FLOW DEPTH) (FT)	0.40	0.55		
CHANNEL TOP WIDTH @ FLOW DEPTH d (FT)	3.60	5.30		
BOTTOM WIDTH: FLOW DEPTH RATIO (12:1 MAX)	5.00	3.64		
d50 STONE SIZE (IN)	N/A	N/A		
A (CROSS-SECTIONAL AREA) (SQ. FT.)	1.12	2.01		
R (HYDRAULIC RADIUS)	0.30	0.37		
S (BED SLOPE) ³ (FT/FT)	0.01	0.012		
S _c (CRITICAL SLOPE) (FT/FT)	0.024	0.050		
.7S _c (FT/FT)	0.016	0.035		
1.3S _c (FT/FT)	0.031	0.066		
STABLE FLOW? (Y/N)	Y	Y		
FREEBOARD BASED ON UNSTABLE FLOW (FT)	0.06	0.07		
FREEBOARD BASED ON STABLE FLOW (FT)	0.50	0.50		
MINIMUM REQUIRED FREEBOARD ⁴ (FT)	0.50	0.50		
DESIGN METHOD FOR PROTECTIVE LINING ⁵ PERMISSIBLE VELOCITY (V) OR SHEAR STRESS (S)	S	S		

1. Use 1.6 for Temporary Channels; 2.25 for Temporary Channels in Special Protection (HQ or EV) Watersheds; 2.75 for Permanent Channels. For Rational Method, enter "N/A" and attach E&S Worksheets 9 and 10. For TR-55 enter "N/A" and attach appropriate Worksheets.
2. Adjust "n" value for changes in channel liner and flow depth. For vegetated channels, provide data for manufactured linings without vegetation and with vegetation in separate columns.
3. Slopes may not be averaged.
4. Minimum Freeboard is 0.5 ft. or ¼ Total Channel Depth, whichever is greater
5. Permissible velocity lining design method is not acceptable for channels with a bed slope of 10% or greater. Shear stress lining design method is required for channels with a bed slope of 10% or greater. Shear stress lining design method may be used for any channel bed slope.

A.2 Sediment Barrier Table

**E&S WORKSHEET #1
Compost Filter Sock**

PROJECT NAME: ATLANTIC SUNRISE PROJECT - RIVER ROAD REGULATOR STATION

LOCATION: DRUMORE TOWNSHIP, LANCASTER COUNTY, PENNSYLVANIA

PREPARED BY: HFT DATE: 08/24/2015

CHECKED BY: AJB DATE: 08/24/2015

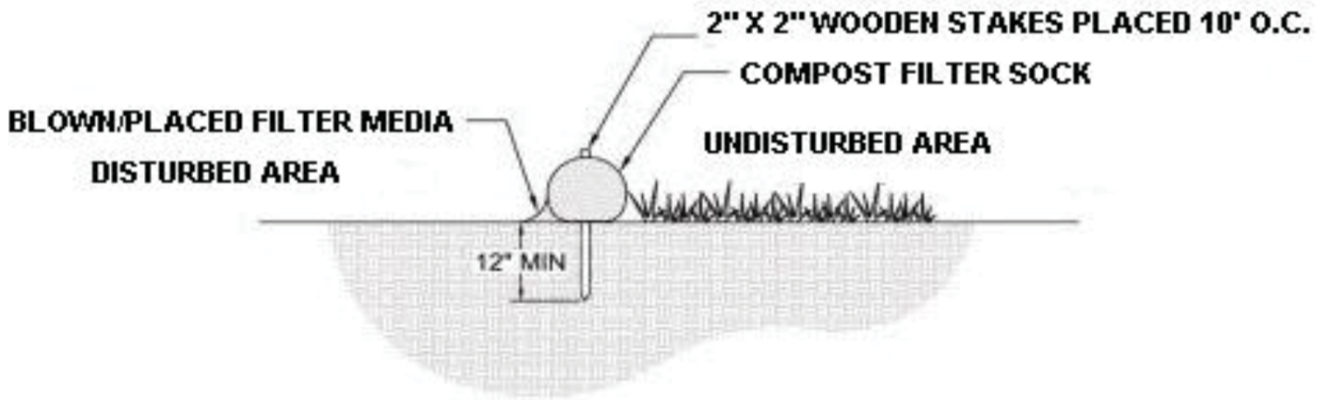

SOCK NO.	Dia. In.	LOCATION	SLOPE PERCENT	SLOPE LENGTH ABOVE BARRIER (FT)
1	32	Downslope from Basin	7-11	427
2	32	Downslope from Basin	7-11	427
3	32	Downslope from Basin	7-11	427
4	12	Upslope from Basin	7.0	127
5	18	Along North LOD downslope of Swale	7.0	250
6	18	Along North LOD downslope of Swale	7.0	250
7	12	South of Rock Springs site	10.0	122
8	12	Topsoil Stockpile	50.0	25
9	12	Infiltration Areas	33.0	30
10	12	Upslope from Basin	7.0	20
11	18	Rock Construction Entrance	7.0	31

SOURCE: Pennsylvania Erosion and Sediment Pollution Control Manual, Page 372



An Employee-Owned Company

A.3 Supporting Information

Channel Report

ES-1 Storm Sewer

Circular

Diameter (ft) = 1.00

Invert Elev (ft) = 609.00

Slope (%) = 7.00

N-Value = 0.015

Calculations

Compute by: Known Q

Known Q (cfs) = 2.37

Highlighted

Depth (ft) = 0.37

Q (cfs) = 2.370

Area (sqft) = 0.27

Velocity (ft/s) = 8.94

Wetted Perim (ft) = 1.31

Crit Depth, Y_c (ft) = 0.66

Top Width (ft) = 0.97

EGL (ft) = 1.61

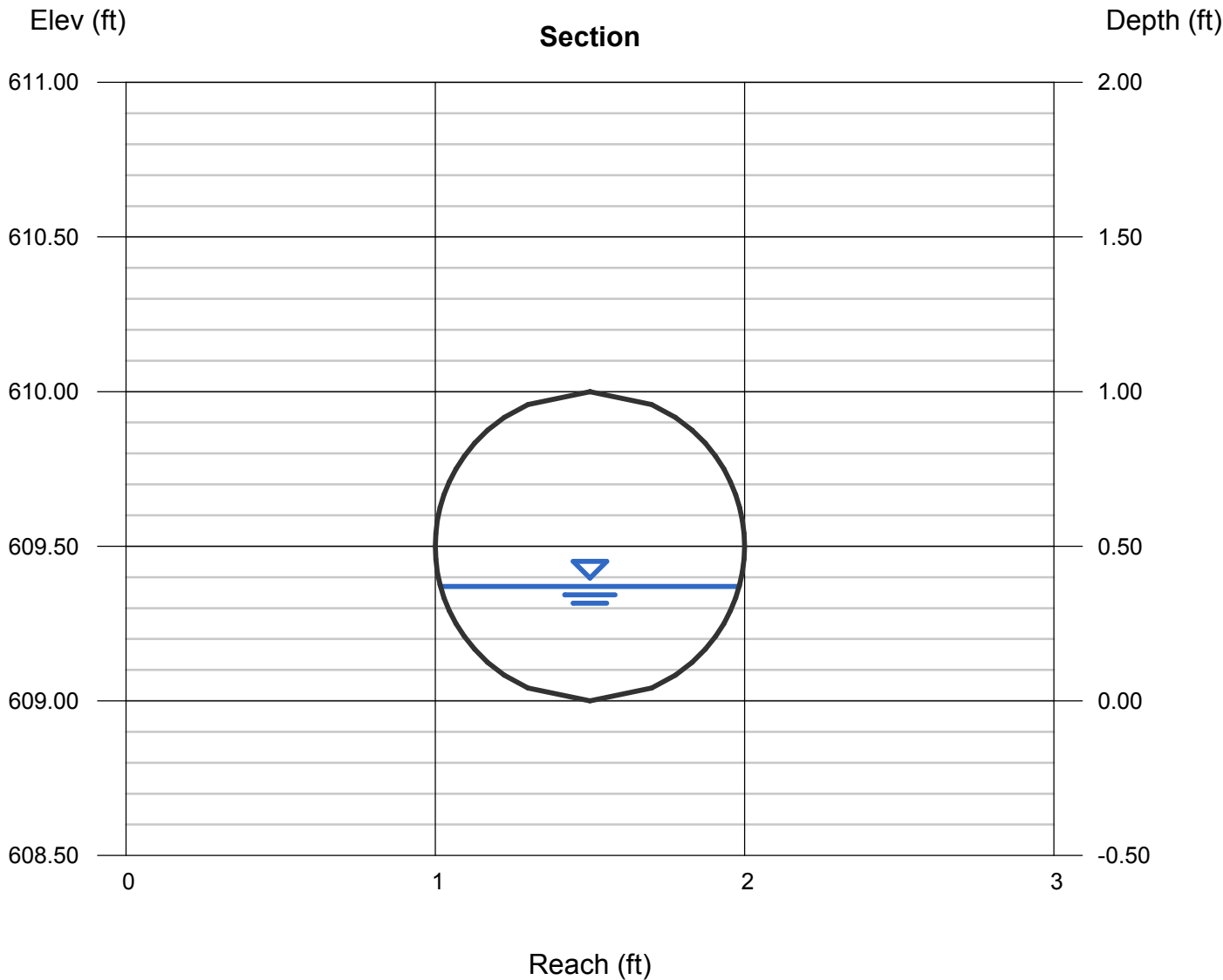

END SECTION 1 (ES-1) - RIP RAP APRON DESIGN

DESIGN OF RIPRAP APRON OUTLET PROTECTION FROM A ROUND PIPE FLOWING FULL
 MINIMUM TAILWATER CONDITION ($T_w < 0.5$ DIAMETER)

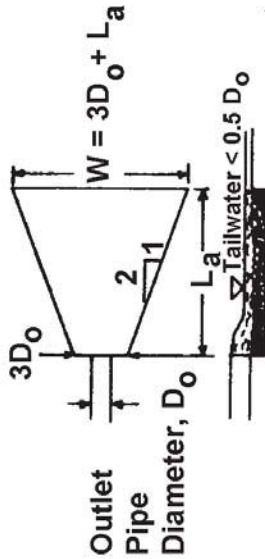

$D_o = 1'$
 $3D_o = 3'$
 $L_a = 6'$
 $W = 9'$

MAX. ALLOWABLE VELOCITY FOR R-4 RIP RAP = 9.0 FPS
 (E&S MANUAL, TABLE 6.6, ATTACHED HERETO IN APP. A.3)
 CALCULATED VELOCITY = 8.94 FPS
 (ES 1 CHANNEL REPORT)

FIGURE 9.3
Riprap Apron Design, Minimum Tailwater Condition

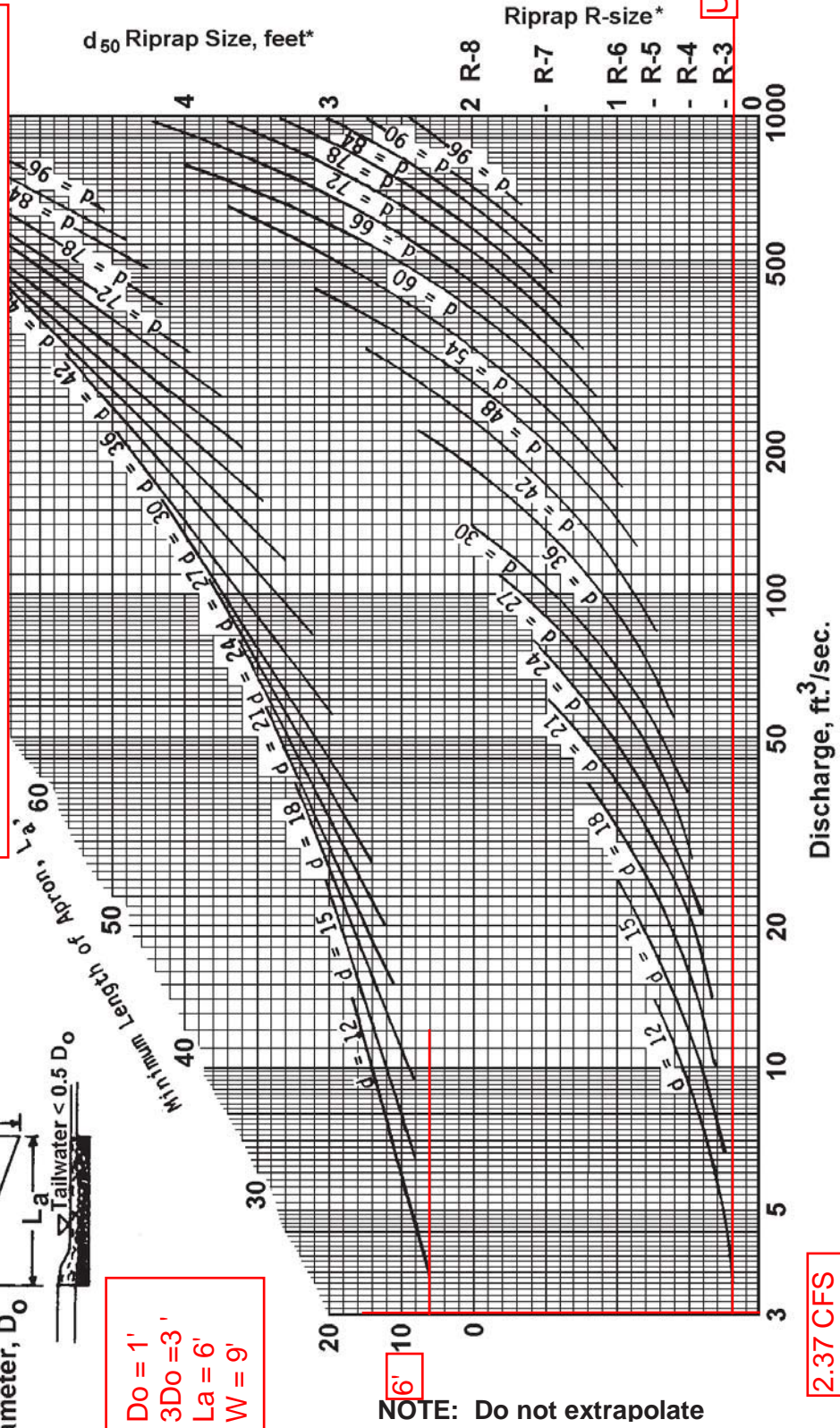

* For discharge velocities exceeding Maximum Allowable for Riprap indicated, increase d_{50} stone size and/or provide velocity reduction device.

Not to be used for Box Culverts

END SECTION 2 (ES-2) - RIP RAP APRON DESIGN

DESIGN OF RIPRAP APRON OUTLET PROTECTION FROM A ROUND PIPE FLOWING FULL
 MINIMUM TAILWATER CONDITION ($T_w < 0.5$ DIAMETER)

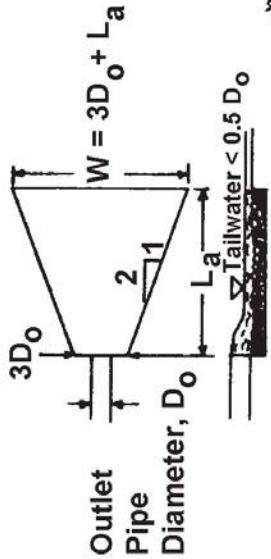

$D_o = 1.5'$
 $3D_o = 4.5'$ (use 5')
 $L_a = 8'$
 $W = 14'$

MAX. ALLOWABLE VELOCITY FOR R-3 RIP RAP = 6.5 FPS
 (E&S MANUAL, TABLE 6.6, ATTACHED HERETO IN APP. A.4)
 CALCULATED VELOCITY = 3.19 FPS
 (HYDROCAD REPORT FOR 100 YR BASIN DISCHARGE)

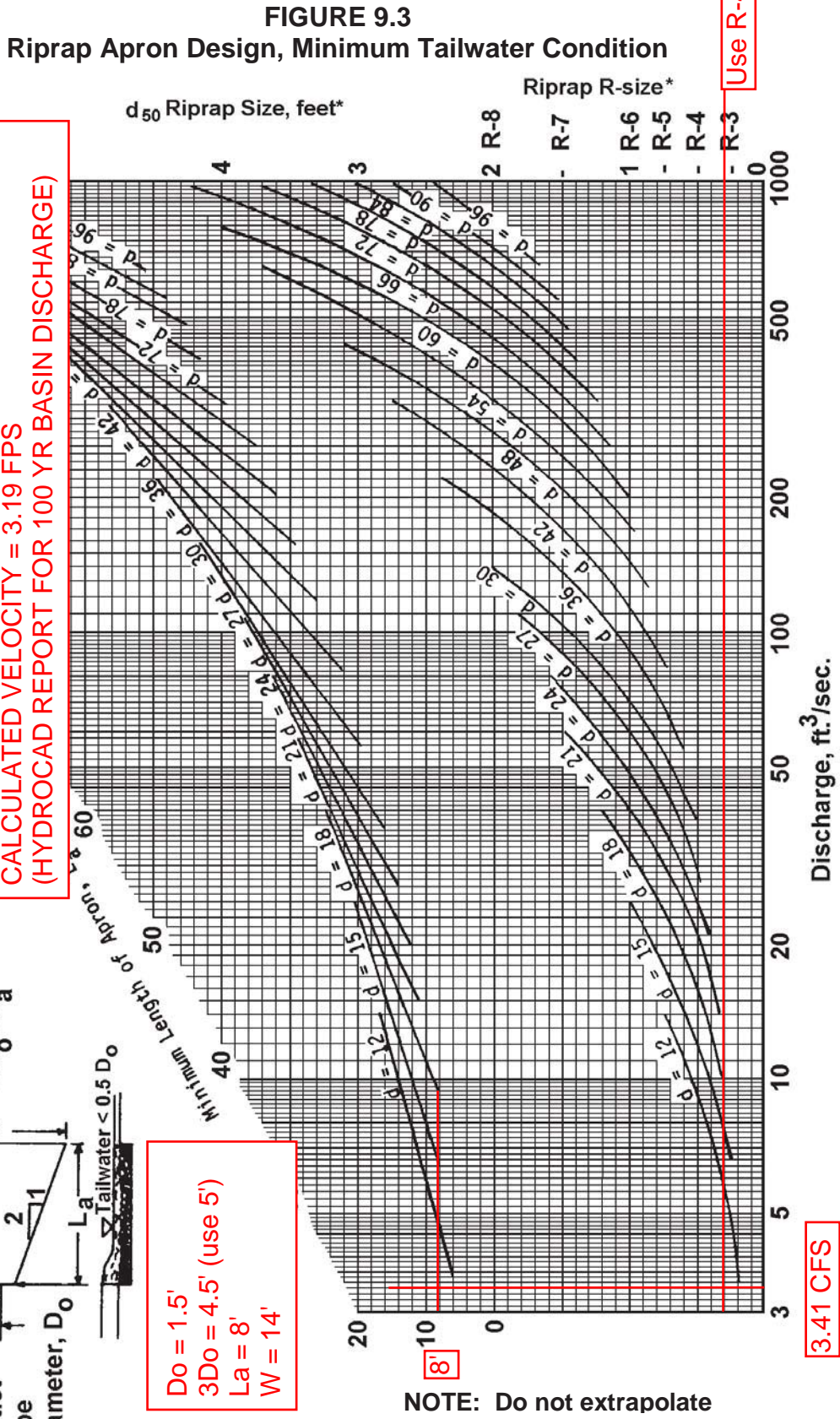

NOTE: Do not extrapolate

3.41 CFS

Use R-4

* For discharge velocities exceeding Maximum Allowable for Riprap indicated, increase d_{50} stone size and/or provide velocity reduction device.

Not to be used for Box Culverts

VEGETATED SWALE - RIP RAP APRON DESIGN

**FIGURE 9.3
Riprap Apron Design, Minimum Tailwater Condition**

DESIGN OF RIPRAP APRON OUTLET PROTECTION FROM A ROUND PIPE FLOWING FULL
MINIMUM TAILWATER CONDITION ($T_w < 0.5$ DIAMETER)

MAX. ALLOWABLE VELOCITY FOR R-4 RIP RAP = 9.0
FPS
(E&S MANUAL, TABLE 6.6, ATTACHED HERETO IN
APP. A.4)
CALCULATED VELOCITY = 3.01 FPS

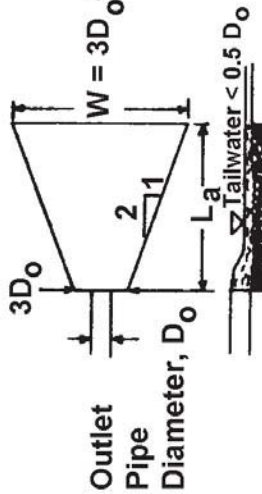

$D_o = 1'$
 $3D_o = 3'$ (use 8',
swale top width)
 $L_a = 6'$
 $W = 14'$

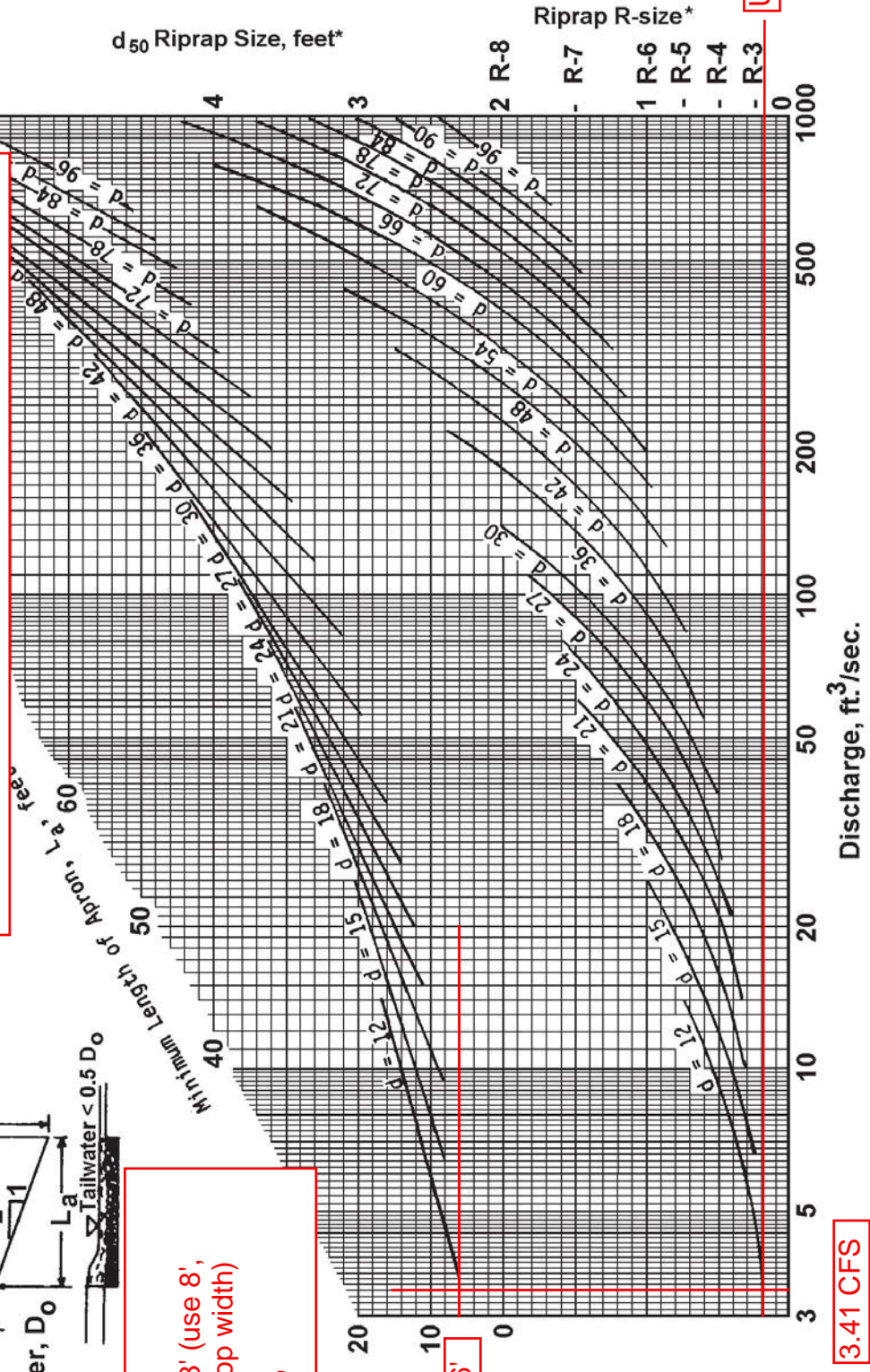

NOTE: Do not extrapolate

* For discharge velocities exceeding Maximum Allowable for Riprap indicated, increase d_{50} stone size and/or provide velocity reduction device.

Not to be used for Box Culverts

STANDARD E&S WORKSHEET # 20 Riprap Apron Outlet Protection

PROJECT NAME: ATLANTIC SUNRISE PROJECT - RIVER ROAD REGULATOR STATION
 LOCATION: DRUMORE TOWNSHIP, LANCASTER COUNTY, PENNSYLVANIA
 PREPARED BY: HFT DATE: 8/24/2016
 CHECKED BY: AJB DATE: 8/24/2016

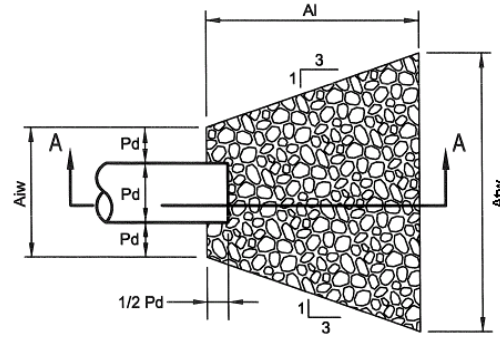

PLAN VIEW

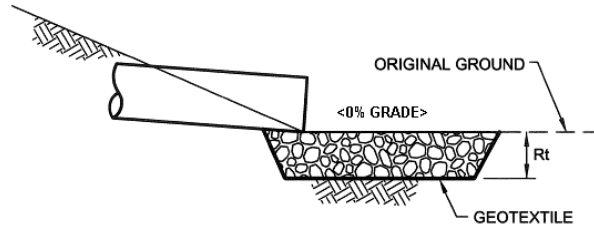

SECTION A - A

NO.	PIPE DIA. Do (in.)	TAIL WATER COND. (Max or Min)	MAN. "n" FOR PIPE	PIPE SLOPE (FT/FT)	Q (CFS)	V* (FPS)	RIPRAP SIZE	Rt (in)	Al (ft)	Aiw (ft)	Atw (ft)
ES-1	12	MIN	0.015	0.07	2.37	8.94	R-4	18	6	3	9
ES-2	18	MIN	0.015	0.0125	3.41	3.19	R-4	18	8	5	14

*:The anticipated velocity (V) should not exceed the maximum permissible shown in Table 6.6 for the proposed riprap protection. Adjust for less than full pipe flow. Use Manning's equation to calculate velocity for pipe slopes ≥ 0.05 ft/ft.

TABLE 6.6
Riprap Gradation, Filter Blanket Requirements, Maximum Velocities

Percent Passing (Square Openings)						
Class, Size NO.	R-8	R-7	R-6	R-5	R-4	R-3
Rock Size (Inches)						
42	100					
30		100				
24	15-50		100			
18		15-50		100		
15	0-15					
12		0-15	15-50		100	
9				15-50		
6			0-15		15-50	100
4				0-15		
3					0-15	15-50
2						0-15
Nominal Placement Thickness (inches)	63	45	36	27	18	9
Filter Stone ¹	AASHTO #1	AASHTO #1	AASHTO #1	AASHTO #3	AASHTO #3	AASHTO #57
V _{max} (ft/sec)	17.0	14.5	13.0	11.5	9.0	6.5

Adapted from PennDOT Pub. 408, Section 703.2(c), Table C

- 1 This is a general standard. Soil conditions at each site should be analyzed to determine actual filter size. A suitable woven or non-woven geotextile underlayment, used according to the manufacturer's recommendations, may be substituted for the filter stone for gradients < 10%.

TABLE 6.7
Comparison of Various Gradations of Coarse Aggregates

Total Percent Passing															
AASHTO NUMBER	6 ½"	4"	3 ½"	2 ½"	2"	1 ½"	1"	¾"	½"	⅜"	#4	#8	#16	#30	#100
1		100	90-100	25-60		0-15		0-5							
3				100	90-100	35-70	0-15		0-5						
5						100	90-100	20-55	0-10	0-5					
57						100	90-100		25-60		0-10	0-5			
67							100	90-100		20-55	0-10	0-5			
7								100	90-100	40-70	0-15	0-5			
8									100	85-100	10-30	0-10	0-5		
10										100	75-100				10-30

PennDOT Publication 408, Section 703.2(c), Table C

Tables 6.6 and 6.7 should be placed on the plan drawings of all sites where riprap channel linings are proposed.

Busher, Al

From: Jill Pack <JPack@tensarcorp.com>
Sent: Monday, November 17, 2014 12:15 PM
To: abuser@blcompanies.com
Subject: Performance of SC150

Mr. Busher,

As we spoke about on the phone, there are a lot of factors that could influence the performance and life of our products. Generally speaking the 24 month longevity of the SC150 is the average functional longevity, and so the stated design values should stay near 100% during that time frame. But as we know climates and conditions vary, so if you are in conditions where the erosion control blanket would see increases in degradation time (extreme UV conditions, large shifts in moisture and temperature, etc.) then the functionality would be reduced to some degree. This is difficult to measure as no current testing standards for temporary products test beyond initial product installation. Also since these products are typically used in conjunction with establishing vegetation, the vegetation would have an impact on the performance of the system together and would typically strengthen the system once the vegetation develops.

I would also note that we do offer a longevity warranty on all of our temporary products that equates to 75% of the stated functional longevity. So for a 24 month product we do warranty that it will last and perform a minimum of 18 months. This further supports our confidence in the quality and performance of our products.

If you have any additional questions, please feel free to contact me.

Thanks,

Jill Pack, CPESC | Product Manager - Erosion Control



Tensar International Corporation | 5401 St. Wendel – Cynthiana Road | Poseyville, IN 47633 | Office: 812-867-6632 | Toll Free: 800-772-2040 | Fax: 812-867-0247 | jpack@tensarcorp.com | www.nagreen.com

This message has been scanned for malware by Websense. www.websense.com

ROLLED EROSION CONTROL

SYSTEMS BROCHURE

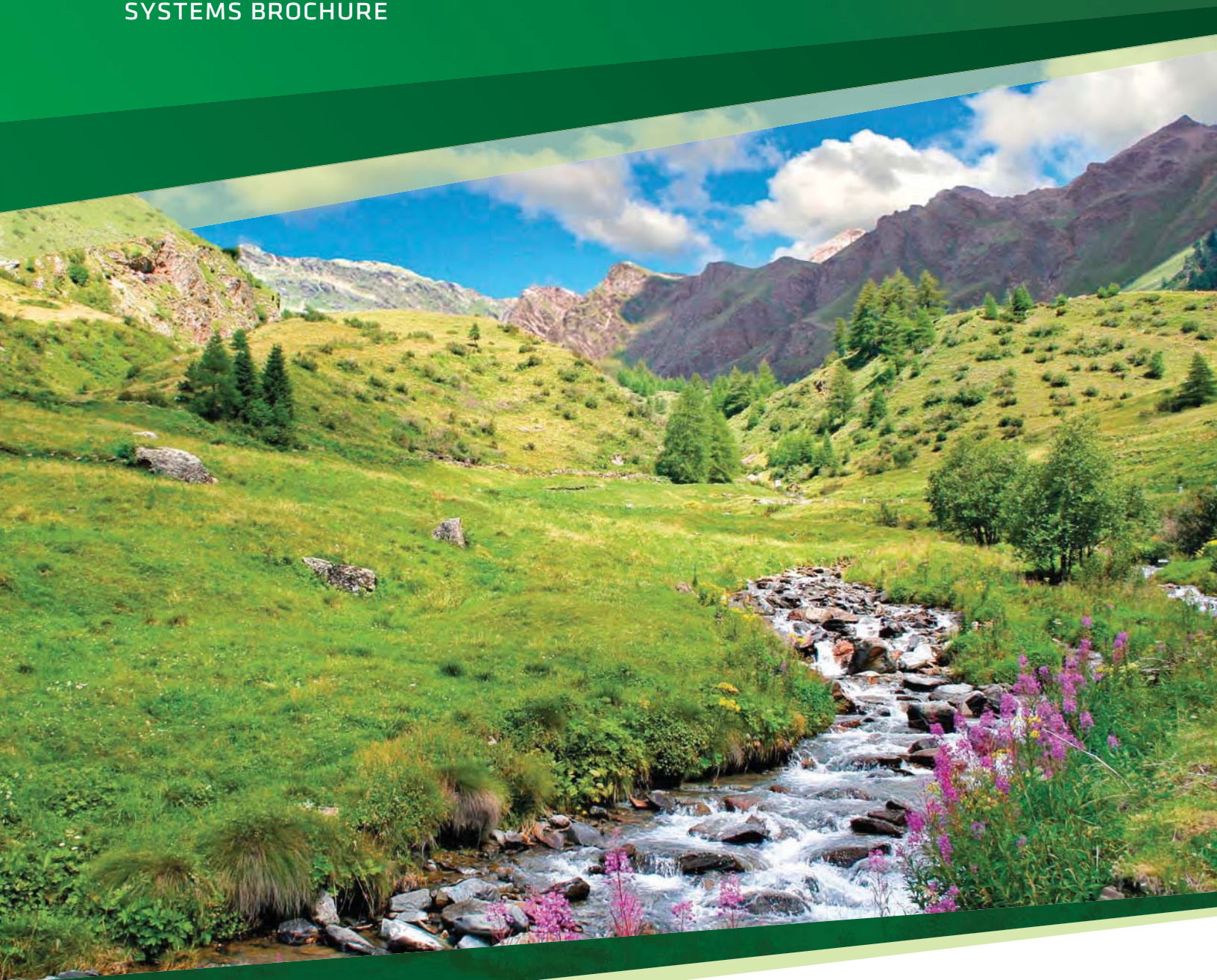



When It Rains (or Blows, Flows or Washes), It Pours

Erosion not only wears away slopes, degrades shorelines and steals precious topsoil, it can also threaten water sources, damage man-made structures, reconfigure landscapes and disrupt wildlife habitats. Add the stiff penalties at stake for violating Environmental Protection Agency (EPA) or local enforcement agency regulations, and the costs of erosion can quickly climb out of control.

WE ROLL AGAINST THE FLOW

Tensar International Corporation (Tensar) is the world's leading provider of performance-guaranteed erosion control solutions. For more than 25 years, the Tensar® North American Green® line of erosion and sediment control products has kept our customers on solid ground.

The RollMax™ Systems' family of Rolled Erosion Control Products (RECPs) is solid evidence of Tensar's ongoing investment in innovation. Our short-term and long-term erosion control blankets and turf reinforcement mats keep you one step ahead of just about any erosion challenge.

ALL THE HELP YOU NEED

Of all the RECP manufacturers out there, none can match Tensar's customer service and technical knowhow. Our support team will assist with project design and product

specification or, if you'd rather do it yourself, use our Erosion Control Materials Design Software (ECMDS®) (the industry's first) for selecting material, and planning your project.

Tensar products are sold exclusively through nearly 200 Tensar Erosion Control authorized distributors worldwide. The Tensar Erosion Solutions Specialist program certifies our distributors and their sales representatives to design erosion control measures that comply with the EPA's National Pollutant Discharge Elimination System (NPDES) and other industry regulations.

Tensar is a proud member of the Erosion Control Technology Council (ECTC) and the International Erosion Control Association (IECA).

NEW NAME - SAME GREAT PERFORMANCE AND SERVICE

Tensar International Corporation acquired North American Green (NAG) in 2004 to enhance our position as the premier provider of technology-driven site solutions. We are proud to continue offering the same NAG level of service, quality and high-performance erosion control products under the name of Tensar.



Site erosion can be costly, with the RollMax Systems full line of rolled erosion control products we can keep you in compliance.



For more than 25 years, our Tensar North American Green line of products has kept our customers on solid ground.



Applications Welcome

For nearly every erosion application, there's a RollMax™ Systems solution. Permanent turf reinforcement mats provide long-term protection and vegetation establishment; temporary Erosion Control Blankets (ECBs) give immediate protection and assist with vegetation establishment before degrading naturally. Tensar's extensive selection of RollMax products almost guarantees you'll find the answer to your erosion problems.

Typical erosion control applications include these and many more:

- ▶ Highway and other DOT projects
- ▶ Commercial and residential developments
- ▶ Shorelines and waterways
- ▶ Golf course turf management
- ▶ Oil and gas pipeline restoration
- ▶ Mine and fire reclamation
- ▶ Military base construction

AND SPEAKING OF GUARANTEES . . .

Tensar's Ultimate Assurance Guarantee is the most comprehensive in the industry. It says if any properly specified and installed Tensar® North American Green® rolled erosion control product designed by a qualified engineer or Tensar technical representative in accordance with our Erosion Control Materials Design Software (ECMDS®) fails to perform under the conditions in the Guarantee, then we will replace the failed product with our next higher-performance RECP product, along with the cost of seed, fertilizer, topsoil and other amendments lost due to such product failure. Our Guarantee warrants in accordance with its terms and conditions all registered projects designed with the latest version of our ECMDS and properly installed.

Tensar turf reinforcement mats are also guaranteed to reinforce vegetation for five years after installation, and the functional longevity of these products' permanent structures is warranted for a minimum of 10 years after installation, subject to the terms and conditions set forth in the Guarantee.



From challenging roadway improvements to concentrated flow channels, there is a RollMax product ready to handle the job – and it's guaranteed.

Permanent RollMax™ Solutions



Back in the day, rock riprap, articulated concrete blocks and poured concrete were the only way to deal with erosion in high-flow channels, on shorelines and other areas where water and/or wind exceed the shear limits of unreinforced vegetation.

Not anymore. Tensar's permanent Turf Reinforcement Mats (TRMs) use 100% synthetic components or a composite of synthetic and natural materials for long-term erosion protection and vegetation establishment. Whether compared to rock riprap or concrete, the RollMax™ Systems' permanent TRMs offer a number of significant advantages:

- ▶ Prevent loss of precious topsoil to wind and water erosion
- ▶ Permanently reinforce vegetation root and stem structures
- ▶ Provide excellent conditions for quick, healthy vegetation growth
- ▶ Stabilize slopes from erosion to keep roadways safe and clean
- ▶ Protect water quality in lakes, rivers and streams
- ▶ Protect dormant seeding during winter months
- ▶ Easily conform to landscape features
- ▶ Lightweight for easy handling and transportation



The TRMs easily conform to various landscape features to prevent the loss of precious topsoil.

VMAX® COMPOSITE TURF REINFORCEMENT MATS

VMax® C-TRMs combine three-dimensional matting with fiber matrix material for permanent erosion control on severe slopes, spillways, stream banks, shorelines and in high- to extreme-flow channels. These extensively tested products provide maximum performance through all three phases of reinforced vegetative lining development: unvegetated, establishment, and maturity. Incorporating the best performance features of temporary and permanent Tensar erosion control products, VMax C-TRMs deliver these tangible benefits:

- ▶ Surface-applied for the highest level of immediate soil protection
- ▶ Less than one third of the installed cost of rock or concrete
- ▶ No heavy equipment needed to install
- ▶ More attractive and effective "Green" alternative than rock riprap or concrete
- ▶ Exceeds FHWA and ECTC standards for TRMs
- ▶ An EPA Best Management Practice (BMP) for National Pollutant Discharge Elimination System (NPDES) regulations
- ▶ No threat to pedestrians or automobiles when used near travel routes
- ▶ Naturally filters runoff water



The RollMax TRMs are installed in a one-step operation directly over the prepared seedbed saving time and money and ensuring the highest level of erosion control and vegetation reinforcement.



VMax® P550® Permanent TRM

Our top of the line P550® TRM has a polypropylene fiber matrix augmenting the permanent netting structure with permanent mulching and erosion control performance. Unvegetated, the P550 TRM reduces soil loss to less than 0.5 in. (12.7 mm) under shear stress up to 4.0 lbs/ft² (191 Pa). The ultra-strong structure drives the vegetated shear resistance up to 14 lbs/ft² (672 Pa), establishing a new maximum for vegetation reinforcement. The P550 TRM may be used as an alternative for poured concrete or articulated concrete blocks in extreme erosion control projects.

VMax® C350® Permanent TRM

A 100% coconut fiber matrix supplements the C350's permanent three-dimensional netting structure with initial mulching and erosion control performance for up to 36 months. Unvegetated, the C350® TRM reduces soil loss to less than 0.5 in. (12.7 mm) under shear stress up to 3.2 lbs/ft² (153 Pa) and boosts permanent vegetation performance up to 12 lbs/ft² (576 Pa). This environmentally friendly alternative to 30 in. (76 cm) or larger rock riprap is ideal for severe erosion control projects.

VMax® SC250® Permanent TRM

The SC250® permanent TRM has a 70% straw/30% coconut fiber matrix to enhance initial mulching and erosion control performance for up to 24 months. Unvegetated, SC250 TRMs reduce soil loss to less than 0.5 in. (12.7 mm) under shear stress up to 3.0 lbs/ft² and increases permanent vegetation performance up to 10 lbs/ft² (480 Pa) for a green alternative to rock riprap.

ERONET™ PERMANENT EROSION CONTROL BLANKETS

The EroNet™ Permanent ECB provides immediate erosion protection and vegetation establishment assistance until vegetation roots and stems mature.

EroNet™ P300® Permanent Erosion Control Blankets

The P300® permanent erosion control blanket consists of UV-stabilized polypropylene fiber stitched between heavy-weight UV-stabilized polypropylene top and bottom nets. These mats reduce soil loss and protect vegetation from being washed away or uprooted, even under high stress. Unvegetated, they reduce soil loss to less than 0.5 in. (12.7 mm) under shear stress up to 3.0 lbs/ft² (144 Pa), and protect vegetation from being washed away or uprooted when exposed to shear stresses up to 8 lbs/ft² (383 Pa).



To boost performance of the VMax turf reinforcement mats in critical applications, combine with our ShoreMax® flexible transition mat to create a system that can dramatically elevate the permissible shear stress and velocity protection beyond many hard armor solutions.



VMax Mats are perfect for pipe outlets, channel bottoms, shoreline transition zones, and other areas subjected to highly turbulent water flows.

Temporary RollMax™ Solutions



Erosion control has never been so simple yet effective. Tensar's RollMax™ temporary Erosion Control Blankets (ECBs) provide immediate erosion protection and vegetation establishment assistance, then degrade once the vegetation's root and stem systems are mature enough to stabilize the soil.

Our high-quality temporary solutions are available in varying functional longevities and materials:

- ▶ Short-term photodegradable blankets with a functional longevity of 45 days up to 12 months
- ▶ Extended-term and long-term photodegradable blankets for protection up to 36 months
- ▶ Short-term biodegradable blankets for protection up to 12 months
- ▶ Extended-term and long-term biodegradable products for protection and mulching from 18 to 24 months

ERONET™ EROSION CONTROL BLANKETS

Tensar's EroNet™ ECBs incorporate photodegradable nettings, which means they are broken down by the ultraviolet rays in sunlight. These temporary products can be used in a variety of scenarios, including moderate to steep slopes, medium- to high-flow channels, shorelines and other areas needing protection until permanent vegetation establishment.

EroNet™ C125® Long-Term Photodegradable Double-Net Coconut Blanket

The C125® ECB is made of 100% coconut fiber stitched between heavyweight UV-stabilized polypropylene nets. It offers excellent durability, erosion control and longevity for severe slopes, steep embankments, high-flow channels and other areas where vegetation may take up to 36 months to grow in.



The EroNet temporary ECBs are designed to provide immediate erosion protection and vegetation establishment assistance, and then degrade after the vegetation is mature enough to permanently stabilize the underlying soil. Both short-term and extended-term ECBs are available.



EroNet™ SC150® Extended-Term Photodegradable Double-Net Straw/Coconut Blanket

With a layer of 70% straw and 30% coconut fiber stitched between a heavyweight UV-stabilized polypropylene top net and a lightweight photodegradable polypropylene bottom net, the SC150® ECB has increased durability, erosion control capabilities and longevity. It is suitable for steeper slopes, medium-flow channels and other areas where it may take vegetation up to 24 months to grow in.

EroNet™ S150® Short-Term Photodegradable Double-Net Straw Blanket

The S150 ECB is made with a 100% straw fiber matrix stitched between lightweight photodegradable polypropylene top and bottom nets. The S150 ECB's double-net construction has greater structural integrity than single net blankets for use on steeper slopes and in channels with moderate water flow. It provides erosion protection and mulching for up to 12 months.



Every site has its own unique characteristics and challenges. EroNet Erosion Control Blankets are available in varying longevities to suit a variety of scenarios and conditions.

EroNet™ DS150™ Ultra Short-Term Photodegradable Double-Net Straw Blanket

The DS150™ ECB is suitable for high maintenance areas where close mowing will occur soon after installation. Special additives in the thread and top and bottom net ensure it degrades in adequate sunlight within 60 days.

EroNet™ S75® Short-Term Photodegradable Single-Net Straw Blanket

The S75® ECB protects and mulches moderate slopes and low-flow channels in low maintenance areas for up to 12 months. It is constructed of 100% straw fiber stitched with degradable thread to a lightweight photodegradable polypropylene top net.

EroNet™ DS75™ Ultra Short-Term Photodegradable Single-Net Straw Blanket

Designed for high maintenance areas where close mowing will occur soon after installation, the DS75™ ECB degrades within 45 days because of special additives in the thread and top net that facilitate rapid breakdown in adequate sunlight.



With our Erosion Control Materials Design Software (ECMDS), you can select either short-term, extended-term or long-term EroNet blankets based on your specific design needs.

Temporary RollMax™ Solutions



BIONET® EROSION CONTROL BLANKETS

BioNet® 100% biodegradable ECBs provide effective and all-natural erosion control and vegetation establishment in an environmentally and wildlife friendly manner. All products in the line are made of organic, biodegradable materials perfect for bioengineering applications, environmentally sensitive sites, shaded areas, stream banks and shorelines. Other advantages are:

- ▶ Little to no risk of wildlife entrapment
- ▶ Easy to sprig or plant through
- ▶ High durability, fiber retention and mechanical stability with Leno weave technology
- ▶ Increased water absorption with jute netting vs. polypropylene netting
- ▶ Improved blanket conformance and adherence to soil vs. polypropylene netting
- ▶ Enhanced erosion protection and mulching capabilities vs. polypropylene netting
- ▶ Durable, flexible and 100% biodegradable
- ▶ Lightweight jute netting requires no direct sunlight exposure to initiate degradation



BioNet® C125BN™ Long-Term Biodegradable Double-Net Coconut Blanket

A dense layer of coconut fiber stitched between jute nettings allows the C125BN™ ECB to provide more effective erosion protection and mulch than open weave coir nettings. This product performs in critical applications for up to 24 months.

BioNet® SC150BN™ Extended-Term Biodegradable Double-Net Straw/Coconut Blanket

The SC150BN™ ECB features a layer of 70% straw and 30% coconut fiber stitched between biodegradable jute top and bottom nettings. It provides erosion protection and mulching for up to 18 months in applications requiring extra strength and erosion control properties.

BioNet® S150BN™ Short-Term Biodegradable Double-Net Straw Blanket

The S150BN™ ECB is used for applications requiring greater durability and performance than a single-net biodegradable ECB can provide. Made with a 100% straw fiber matrix stitched between biodegradable jute top and bottom nettings, it offers up to 12 months of erosion protection and mulching action.

BioNet® S75BN™ Short-Term Biodegradable Single-Net Straw Blanket

Consisting of a 100% straw fiber matrix stitched to a biodegradable jute top nettings, the S75BN™ ECB provides better erosion protection and mulching action than conventional open weave jute nettings alone. The S75BN ECB provides up to 12 months of erosion control and vegetation growth support.

Design and Installation Tools



SHIFT, CONTROL, ENTER

Professional guidance on RECP selection, design and project planning is at your fingertips with Tensar's proprietary Erosion Control Materials Design Software (ECMDS®). This web-based program incorporates design methodologies from the Federal Highway Administration and United States Department of Agriculture to analyze your specific site conditions, and make quantified recommendations based on data from controlled laboratory and field research. ECMDS is a must-have if you face tough erosion and sediment control regulations. Best of all, it's free of charge, compliments of Tensar. To learn more and access the software directly, go to www.ECMDS.com.

INSTRUCTIONS INCLUDED

Proper anchoring patterns and rates must be used to achieve optimal results in RECP installation. View our installation guides for stapling patterns. Site specific staple pattern recommendations based on soil type and severity of application may be acquired through our ECMDS.



HOLD ON TIGHT

When under the pressure of severe conditions, even the best erosion control products can't function to their full potential without proper installation and anchoring. Tensar supplies a wide variety of fastener options for nearly every application and soil type.

For use in cohesive soils, wire staples are a cost-effective means to fasten RECPs. Available in 6 in., 8 in., 10 in. and 12 in. lengths, our U-shaped staples can reach to various depths to ensure adequate pull-out resistance. For installation using our handy Pin Pounder installation tool, 6 in. V-top staples or 6 in. circle top pins are available.

Our biodegradable BioStakes® are available in 4 in. and 6 in. lengths and provide an environmentally friendly alternative to metal staples. For an even more durable, deeper reaching yet all-natural anchoring option, our wood EcoStakes® are available in 6 in., 12 in., 18 in. and 24 in. lengths.

For severe applications needing the ultimate, long-lasting hold, try our 12 and 18 in. rebar staples, our 12 in. plastic ShoreMax® stakes, or our complete line of percussion earth anchors. The Tensar earth anchors reach deep into the soil strata to offer enhanced anchoring in the worst conditions. Our variety of earth anchors are designed for durability and holding power under extreme hydraulic stresses and adverse soil conditions (Table 1).

For more information on the RollMax Systems or other systems within the Tensar Erosion Control Solutions, call **800-TENSAR-1** or visit www.tensarcorp.com.

Earth Anchor Options

	Tendon Type (½ in. x 36 in.)	Assembly Description	EA 400		EA 680			
			Fast Install	Economic Anchor	Stainless	Galvanized	Stainless	Galvanized
End Piece Options with a PVC Face Plate	Copper Stop Sleeve with Stainless Steel Washer	Manually crimped to the stainless steel cable to secure the face plate.		X	X		X	
	Grip End Piece with Stainless Steel Washer	Three-dimensional, self-securing metal end piece that does not require manual crimping for tendon tensioning.	X	X	X	X	X	X
	Wedge Grip Piece	Self-securing end piece that installs flush to the face plate. Does not require manual crimping for tendon tensioning.	X		X	X	X	X
	Aluminum Stop Sleeve with Stainless Steel Washer	Manually crimped to the galvanized cable to secure the face plate.		X		X		X

TABLE 1





The complete line of RollMax™ products offers a variety of options for both short-term and permanent erosion control needs. Reference the RollMax Products Chart below to find the right solution for your next project.



RollMax Product Selection Chart

	TEMPORARY						
	ERONET						BIONET
	DS75	DS150	S75	S150	SC150	C125	S75BN
Longevity	45 days	60 days	12 mo.	12 mo.	24 mo.	36 mo.	12 mo.
Applications	Low Flow Channels 4:1-3:1 Slopes	Moderate Flow Channels 3:1-2:1 Slopes	Low Flow Channels 4:1-3:1 Slopes	Moderate Flow Channels 3:1-2:1 Slopes	Medium Flow Channels 2:1-1:1 Slopes	High-Flow Channels 1:1 and Greater Slopes	Low Flow Channels 4:1-3:1 Slopes
Design Permissible Shear Stress lbs/ft ² (Pa)	Unvegetated 1.55 (74)	Unvegetated 1.75 (84)	Unvegetated 1.55 (74)	Unvegetated 1.75 (84)	Unvegetated 2.00 (96)	Unvegetated 2.25 (108)	Unvegetated 1.60 (76)
Design Permissible Velocity ft/s (m/s)	Unvegetated 5.00 (1.52)	Unvegetated 6.00 (1.52)	Unvegetated 5.00 (1.2)	Unvegetated 6.00 (1.83)	Unvegetated 8.00 (2.44)	Unvegetated 10.00 (3.05)	Unvegetated 5.00 (1.52)
Top Net	Lightweight accelerated photodegradable polypropylene 1.50 lbs/1000 ft ² (0.73 kg/100 m ²) approx wt	Lightweight accelerated photodegradable polypropylene 1.50 lbs/1000 ft ² (0.73 kg/100 m ²) approx wt	Lightweight photodegradable polypropylene 1.50 lbs/1000 ft ² (0.73 kg/100 m ²) approx wt	Lightweight photodegradable polypropylene 1.50 lbs/1000 ft ² (0.73 kg/100 m ²) approx wt	Heavyweight UV-stabilized polypropylene 2.9 lbs/1000 ft ² (1.47 kg/100 m ²) approx wt	Heavyweight UV-stabilized polypropylene 2.9 lbs/1000 ft ² (1.47 kg/100 m ²) approx wt	Leno woven, 100% biodegradable jute fiber 9.30 lbs/1000 ft ² (4.53 kg/100 m ²) approx wt
Center Net	N/A	N/A	N/A	N/A	N/A	N/A	N/A
Fiber Matrix	Straw fiber 0.50 lbs/yd ² (0.27 kg/m ²)	Straw fiber 0.50 lbs/yd ² (0.27 kg/m ²)	Straw fiber 0.50 lbs/yd ² (0.27 kg/m ²)	Straw fiber 0.50 lbs/yd ² (0.27 kg/m ²)	Straw/coconut matrix 70% Straw 0.35 lbs/yd ² (0.19 kg/m ²) 30% Coconut 0.15 lbs/yd ² (0.08 kg/m ²)	Coconut fiber 0.50 lbs/yd ² (0.27 kg/m ²)	Straw fiber 0.50 lbs/yd ² (0.27 kg/m ²)
Bottom Net	N/A	Lightweight accelerated photodegradable polypropylene 1.50 lbs/1000 ft ² (0.73 kg/100 m ²) approx wt	N/A	Lightweight photodegradable polypropylene 1.50 lbs/1000 ft ² (0.73 kg/100 m ²) approx wt	Lightweight photodegradable polypropylene 1.50 lbs/1000 ft ² (0.73 kg/100 m ²) approx wt	Heavyweight UV-stabilized polypropylene 2.9 lbs/1000 ft ² (1.47 kg/100 m ²) approx wt	N/A
Thread	Accelerated degradable	Accelerated degradable	Degradable	Degradable	Degradable	UV-stabilized polypropylene	Biodegradable

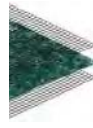

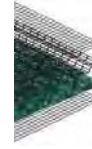
	TEMPORARY			PERMANENT			
	BIONET			ERONET	VMAX		
							
	S150BN	SC150BN	C125BN	P300	SC250	C350	P550
Longevity	12 mo.	18 mo.	24 mo.	Permanent	Permanent	Permanent	Permanent
Applications	Moderate Flow Channels 3:1-2:1 Slopes	Medium Flow Channels 2:1-1:1 Slopes	High-Flow Channels 1:1 and Greater Slopes	High-Flow Channels 1:1 Slopes	High-Flow Channels 1:1 and Greater Slopes	High-Flow Channels 1:1 and Greater Slopes	Extreme High-Flow Channels 1:1 and Greater Slopes
Design Permissible Shear Stress lbs/ft ² (Pa)	Unvegetated 1.85 (88)	Unvegetated 2.10 (100)	Unvegetated 2.35 (112)	Unvegetated 3.0 (144) Vegetated 8.0 (383)	Unvegetated 3.0 (144) Vegetated 10.0 (480)	Unvegetated 3.2 (153) Vegetated 12.0 (576)	Unvegetated 4.0 (191) Vegetated 14.0 (672)
Design Permissible Velocity ft/s (m/s)	Unvegetated 6.00 (1.83)	Unvegetated 8.00 (2.44)	Unvegetated 10.00 (3.05)	Unvegetated 9.00 (2.7) Vegetated 16.0 (4.9)	Unvegetated 9.5 (2.9) Vegetated 15.0 (4.6)	Unvegetated 10.5 (3.2) Vegetated 20.0 (6.0)	Unvegetated 12.5 (3.8) Vegetated 25.0 (7.6)
Top Net	Leno woven, 100% biodegradable jute fiber 9.30 lbs/1000 ft ² (4.53 kg/100 m ²) approx wt	Leno woven, 100% biodegradable jute fiber 9.30 lbs/1000 ft ² (4.53 kg/100 m ²) approx wt	Leno woven, 100% biodegradable jute fiber 9.30 lbs/1000 ft ² (4.53 kg/100 m ²) approx wt	Heavyweight UV-stabilized polypropylene 5.0 lbs/1000 ft ² (2.44 kg/100 m ²) approx wt	Heavyweight polypropylene 5.0 lbs/1000 ft ² (2.44 kg/100 m ²) approx wt	Extra heavyweight polypropylene 8.0 lbs/1000 ft ² (3.91 kg/100 m ²) approx wt	Ultra heavyweight polypropylene 24.0 lbs/1000 ft ² (11.7 kg/100 m ²) approx wt
Center Net	N/A	N/A	N/A	N/A	Ultra heavyweight polypropylene – corrugated 24.0 lbs/1000 ft ² (11.7 kg/100 m ²)	Ultra heavyweight polypropylene – corrugated 24.0 lbs/1000 ft ² (11.7 kg/100 m ²)	Ultra heavyweight polypropylene – corrugated 24.0 lbs/1000 ft ² (11.7 kg/100 m ²)
Fiber Matrix	Straw fiber 0.50 lbs/yd ² (0.27 kg/m ²)	Straw/coconut matrix 70% Straw 0.35 lbs/yd ² (0.19 kg/m ²) 30% Coconut 0.15 lbs/yd ² (0.08 kg/m ²)	Coconut fiber 0.50 lbs/yd ² (0.27 kg/m ²)	UV-stabilized polypropylene fiber 0.70 lbs/yd ² (0.38 kg/m ²)	Straw/coconut matrix 70% Straw 0.35 lbs/yd ² (0.19 kg/m ²) 30% Coconut 0.15 lbs/yd ² (0.08 kg/m ²)	Coconut fiber 0.50 lbs/yd ² (0.27 kg/m ²)	UV-stabilized polypropylene fiber 0.50 lbs/yd ² (0.27 kg/m ²)
Bottom Net	Woven, 100% biodegradable jute fiber 7.70 lbs/1000 ft ² (3.76 kg/100 m ²) approx wt	Woven, 100% biodegradable jute fiber 7.70 lbs/1000 ft ² (3.76 kg/100 m ²) approx wt	Woven, 100% biodegradable jute fiber 7.70 lbs/1000 ft ² (3.76 kg/100 m ²) approx wt	Heavyweight UV-stabilized polypropylene 3.0 lbs/1000 ft ² (1.47 kg/100 m ²) approx wt	Heavyweight UV-stabilized polypropylene 5.0 lbs/1000 ft ² (2.44 kg/100 m ²) approx wt	Extra heavyweight polypropylene 8.0 lbs/1000 ft ² (3.91 kg/100 m ²) approx wt	Ultra heavyweight polypropylene 24.0 lbs/1000 ft ² (11.7 kg/100 m ²) approx wt
Thread	Biodegradable	Biodegradable	Biodegradable	UV-stabilized polypropylene	UV-stabilized polypropylene	UV-stabilized polypropylene fiber	UV-stabilized polypropylene



Tensar International Corporation
2500 Northwinds Parkway, Suite 500
Alpharetta, Georgia 30009
800-TENSAR-1
tensarcorp.com

Distributed by:



Specification Sheet – EroNet™ DS75™ Erosion Control Blanket

DESCRIPTION

The ultra short-term single net erosion control blanket shall be a machine-produced mat of 100% agricultural straw with a functional longevity of up to 45 days. (NOTE: functional longevity may vary depending upon climatic conditions, soil, geographical location, and elevation). The blanket shall be of consistent thickness with the straw evenly distributed over the entire area of the mat. The blanket shall be covered on the top side with a polypropylene netting having an approximate 0.50 x 0.50 (1.27 x 1.27 cm) mesh with photodegradable accelerators to provide breakdown of the netting within approximately 45 days, depending upon geographical location and elevation. The blanket shall be sewn together on 1.50 inch (3.81 cm) centers with degradable thread. The blanket shall be manufactured with a colored thread stitched along both outer edges (approximately 2-5 inches [5-12.5 cm] from the edge) as an overlap guide for adjacent mats.

The DS75 shall meet Type 1.C specification requirements established by the Erosion Control Technology Council (ECTC) and Federal Highway Administration's (FHWA) FP-03 Section 713.17

Material Content		
Matrix	100% Straw Fiber	0.5 lbs/sq yd (0.27 kg/sm)
Netting	Top side only, lightweight photodegradable with photo accelerators	1.5 lb/1000 sq ft (0.73 g/sm)
Thread	Degradable	

Standard Roll Sizes			
Width	6.67 (2.03 m)	8.0 ft (2.4 m)	16 ft (4.87 m)
Length	108 ft (32.92 m)	112 ft (34.14 m)	108 ft (32.92 m)
Weight ± 10%	40 lbs (18.14 kg)	50 lbs (22.68 kg)	96 lbs (43.54 kg)
Area	80 sq yd (66.9 sm)	100 sq yd (83.61 sm)	192 sq yd (165.5 sm)

Index Property	Test Method	Typical
Thickness	ASTM D6525	0.45 in. (11.43 mm)
Resiliency	ECTC Guidelines	78.8%
Water Absorbency	ASTM D1117	375%
Mass/Unit Area	ASTM 6475	8.57 oz/sy (291 g/sm)
Swell	ECTC Guidelines	15%
Smolder Resistance	ECTC Guidelines	Yes
Stiffness	ASTM D1388	6.31 oz-in
Light Penetration	ASTM D6567	10%
Tensile Strength - MD	ASTM D6818	105.6 lbs/ft (1.57 kN/m)
Elongation - MD	ASTM D6818	34%
Tensile Strength - TD	ASTM D6818	42.0 lbs/ft (0.62 kN/m)
Elongation - TD	ASTM D6818	25.2%
Biomass Improvement	ASTM D7322	286%

Design Permissible Shear Stress	
Unvegetated Shear Stress	1.55 psf (74 Pa)
Unvegetated Velocity	5.00 fps (1.52 m/s)

Slope Design Data: C Factors			
Slope Gradients (S)			
Slope Length (L)	≤ 3:1	3:1 – 2:1	≥ 2:1
≤ 20 ft (6 m)	0.029	N/A	N/A
20-50 ft	0.11	N/A	N/A
≥ 50 ft (15.2 m)	0.19	N/A	N/A

Roughness Coefficients – Unveg.	
Flow Depth	Manning's n
≤ 0.50 ft (0.15 m)	0.055
0.50 – 2.0 ft	0.055-0.021
≥ 2.0 ft (0.60 m)	0.021



ROLLMAX™
ROLLED EROSION CONTROL

Specification Sheet – EroNet™ C125® Erosion Control Blanket

DESCRIPTION

The long-term double net erosion control blanket shall be a machine-produced mat of 100% coconut fiber with a functional longevity of up to 36 months. (NOTE: functional longevity may vary depending upon climatic conditions, soil, geographical location, and elevation). The blanket shall be of consistent thickness with the coconut evenly distributed over the entire area of the mat. The blanket shall be covered on the top and bottom sides with a heavyweight photodegradable polypropylene netting having ultraviolet additives to delay breakdown and an approximate 0.63 x 0.63 in (1.59 x 1.59 cm) mesh. The blanket shall be sewn together on 1.50 inch (3.81 cm) centers with degradable thread. The blanket shall be manufactured with a colored thread stitched along both outer edges (approximately 2-5 inches [5-12.5 cm] from the edge) as an overlap guide for adjacent mats.

The C125 shall meet Type 4 specification requirements established by the Erosion Control Technology Council (ECTC) and Federal Highway Administration's (FHWA) FP-03 Section 713.17

Material Content

Matrix	100% Coconut Fiber	0.5 lbs/sq yd (0.27 kg/sm)
Netting	Heavyweight photodegradable with UV additives	3 lbs/1000 sq ft (1.47 g/sm)
Thread	Black polypropylene	

Standard Roll Sizes

Width	6.67 (2.03 m)	8 ft (2.44 m)
Length	108 ft (32.92 m)	112 ft (35.14 m)
Weight ± 10%	44 lbs (19.95 kg)	56.25 (25.5 kg)
Area	80 sq yd (66.9 sm)	100 sq yd (83.61 sm)

Index Property	Test Method	Typical
Thickness	ASTM D6525	0.22 in. (5.59 mm)
Resiliency	ECTC Guidelines	82%
Water Absorbency	ASTM D1117	167%
Mass/Unit Area	ASTM 6475	7.73 oz/sy (262.8 g/sm)
Swell	ECTC Guidelines	13%
Smolder Resistance	ECTC Guidelines	Yes
Stiffness	ASTM D1388	0.75 oz-in
Light Penetration	ASTM D6567	16.6%
Tensile Strength - MD	ASTM D6818	472.8 lbs/ft (7.01 kN/m)
Elongation - MD	ASTM D6818	25.6%
Tensile Strength - TD	ASTM D6818	225.6 lbs/ft (3.35 kN/m)
Elongation - TD	ASTM D6818	33.9%
Biomass Improvement	ASTM 7322	257%

Design Permissible Shear Stress

Unvegetated Shear Stress	2.25 psf (108 Pa)
Unvegetated Velocity	10.0 fps (3.05 m/s)

Slope Design Data: C Factors

Slope Gradients (S)

Slope Length (L)	≤ 3:1	3:1 – 2:1	≥ 2:1
≤ 20 ft (6 m)	0.001	0.029	0.082
20-50 ft	0.036	0.060	0.096
≥ 50 ft (15.2 m)	0.070	0.090	0.110

Roughness Coefficients – Unveg.

Flow Depth	Manning's n
≤ 0.50 ft (0.15 m)	0.022
0.50 – 2.0 ft	0.022-0.014
≥ 2.0 ft (0.60 m)	0.014

Tensar
NORTH AMERICAN GREEN®

Tensar International Corporation
2500 Northwinds Parkway
Suite 500
Alpharetta, GA 30009
800-TENSAR-1
tensarcorp.com

Tensar International Corporation warrants that at the time of delivery the product furnished hereunder shall conform to the specification stated herein. Any other warranty including merchantability and fitness for a particular purpose, are hereby executed. If the product does not meet specifications on this page and Tensar is notified prior to installation, Tensar will replace the product at no cost to the customer. **This product specification supersedes all prior specifications for the product described above and is not applicable to any products shipped prior to January 1, 2012.**

©2013, Tensar International Corporation

EC_RM_X_MPDS_EC125_5.13



ROLLMAX™
ROLLED EROSION CONTROL

Specification Sheet – VMax® C350® Turf Reinforcement Mat

DESCRIPTION

The composite turf reinforcement mat (C-TRM) shall be a machine-produced mat of 100% coconut fiber matrix incorporated into permanent three-dimensional turf reinforcement matting. The matrix shall be evenly distributed across the entire width of the matting and stitch bonded between super heavy duty UV-stabilized nettings with 0.50 x 0.50 in. (1.27 x 1.27 cm) openings, an ultra heavy duty UV-stabilized, dramatically corrugated (crimped) intermediate netting with 0.5 x 0.5 in. (1.27 x 1.27 cm) openings, and covered by a super heavy duty UV-stabilized nettings with 0.50 x 0.50 in. (1.27 x 1.27 cm) openings. The middle corrugated netting shall form prominent closely spaced ridges across the entire width of the mat. The three nettings shall be stitched together on 1.50 in. (3.81 cm) centers with UV-stabilized polypropylene thread to form permanent three-dimensional turf reinforcement matting. All mats shall be manufactured with colored thread stitched along both outer edges as an overlap guide for adjacent mats.

The C350 shall meet Type 5A, B and C specification requirements established by the Erosion Control Technology Council (ECTC) and Federal Highway Administration's (FHWA) *FP-03 Section 713.18*.

Material Content

Matrix	100% Coconut Fiber	0.5 lb/sy (0.27 kg/sm)
Netting	Top and Bottom, UV-Stabilized Polypropylene	8 lb/1000 sf (3.91 kg/100 sm)
	Middle, Corrugated UV-Stabilized Polypropylene	24 lb/1000 sf (11.7 kg/100 sm)
Thread	Polypropylene, UV Stable	

Standard Roll Sizes

Width	6.5 ft (2.0 m)
Length	55.5 ft (16.9 m)
Weight ± 10%	37 lbs (16.8 kg)
Thread	40 sy (33.4 sm)

Index Property	Test Method	Typical
Thickness	ASTM D6525	0.73 in. (18.54 mm)
Resiliency	ASTM D6524	90%
Density	ASTM D792	0.917 g/cm ³
Mass/Unit Area	ASTM D6566	18.36 oz/sy (624 g/sm)
UV Stability	ASTM D4355/ 1000 HR	86%
Porosity	ECTC Guidelines	99%
Stiffness	ASTM D1388	0.24 in.-lb (275990 mg-cm)
Light Penetration	ASTM D6567	7.2%
Tensile Strength - MD	ASTM D6818	585.8 lbs/ft (8.70 kN/m)
Elongation - MD	ASTM D6818	45.3%
Tensile Strength - TD	ASTM D6818	687.6 lbs/ft (10.20 kN/m)
Elongation - TD	ASTM D6818	19.5%
Biomass Improvement	ASTM D7322	380%

Design Permissible Shear Stress

	Short Duration	Long Duration
Phase 1 Unvegetated	3.2 psf (153 Pa)	3.0 psf (144 Pa)
Phase 2 Partially Veg.	10.0 psf (480 Pa)	10.0 psf (480 Pa)
Phase 3 Fully Veg.	12.0 psf (576 Pa)	10.0 psf (480 Pa)
Unvegetated Velocity	10.5 fps (3.2 m/s)	
Vegetated Velocity	20 fps (6.0 m/s)	

Slope Design Data: C Factors

Slope Length (L)	Slope Gradients (S)		
	≤ 3:1	3:1 – 2:1	≥ 2:1
≤ 20 ft (6 m)	0.0005	0.015	0.043
20-50 ft	0.018	0.031	0.050
≥ 50 ft (15.2 m)	0.035	0.047	0.057

Roughness Coefficients – Unveg.

Flow Depth	Manning's n
≤ 0.50 ft (0.15 m)	0.041
0.50 – 2.0 ft	0.040-0.013
≥ 2.0 ft (0.60 m)	0.012



Tensar International Corporation
 2500 Northwinds Parkway
 Suite 500
 Alpharetta, GA 30009
 800-TENSAR-1
 tensarcorp.com

Tensar International Corporation warrants that at the time of delivery the product furnished hereunder shall conform to the specification stated herein. Any other warranty including merchantability and fitness for a particular purpose, are hereby executed. If the product does not meet specifications on this page and Tensar is notified prior to installation, Tensar will replace the product at no cost to the customer. **This product specification supersedes all prior specifications for the product described above and is not applicable to any products shipped prior to January 1, 2012.**

©2013, Tensar International Corporation



ROLLMAX™
ROLLED EROSION CONTROL

Specification Sheet – EroNet™ SC150® Erosion Control Blanket

DESCRIPTION

The extended-term double net erosion control blanket shall be a machine-produced mat of 70% agricultural straw and 30% coconut fiber with a functional longevity of up to 24 months. (NOTE: functional longevity may vary depending upon climatic conditions, soil, geographical location, and elevation). The blanket shall be of consistent thickness with the straw and coconut evenly distributed over the entire area of the mat. The blanket shall be covered on the top side with a heavyweight photodegradable polypropylene netting having ultraviolet additives to delay breakdown and an approximate 0.63 x 0.63 in (1.59 x 1.59 cm) mesh, and on the bottom side with a lightweight photodegradable polypropylene netting with an approximate 0.50 x 0.50 (1.27 x 1.27 cm) mesh. The blanket shall be sewn together on 1.50 inch (3.81 cm) centers with degradable thread. The blanket shall be manufactured with a colored thread stitched along both outer edges (approximately 2-5 inches [5-12.5 cm] from the edge) as an overlap guide for adjacent mats.

The SC150 shall meet Type 3.B specification requirements established by the Erosion Control Technology Council (ECTC) and Federal Highway Administration's (FHWA) FP-03 Section 713.17

Material Content

Matrix	70% Straw Fiber	0.35 lbs/sq yd (0.19 kg/sm)
	30% Coconut Fiber	0.15 lbs/sq yd (0.08 kg/sm)
Netting	Top: Heavyweight photodegradable with UV additives	3 lbs/1000 sq ft (1.47 kg/100 sm)
	Bottom: lightweight photodegradable	1.5 lb/1000 sq ft (0.73 kg/100 sm)
Thread	Degradable	

Standard Roll Sizes

Width	6.67 ft (2.03 m)	8 ft (2.4 m)	16.0 ft (4.87 m)
Length	108 ft (32.92 m)	112 ft (34.14 m)	108 ft (32.92 m)
Weight ± 10%	44 lbs (19.95 kg)	55 lbs (24.95 kg)	105.6 lbs (47.9 kg)
Area	80 sq yd (66.9 sm)	100 sq yd (83.61 sm)	192 sq yd (165.6 sm)

Index Property	Test Method	Typical
Thickness	ASTM D6525	0.35 in. (8.89 mm)
Resiliency	ECTC Guidelines	75%
Water Absorbency	ASTM D1117	342%
Mass/Unit Area	ASTM D6475	7.87 oz/sy (267.6 g/sm)
Swell	ECTC Guidelines	30%
Smolder Resistance	ECTC Guidelines	Yes
Stiffness	ASTM D1388	1.11 oz-in
Light Penetration	ASTM D6567	6.2%
Tensile Strength - MD	ASTM D6818	362.4 lbs/ft (5.37 kN/m)
Elongation - MD	ASTM D6818	29.4%
Tensile Strength - TD	ASTM D6818	136.8 lbs/ft (2.03 kN/m)
Elongation - TD	ASTM D6818	27.6%
Biomass Improvement	ASTM D7322	481%

Design Permissible Shear Stress

Unvegetated Shear Stress	2.00 psf (96 Pa)
Unvegetated Velocity	8.0 fps (2.44 m/s)

Slope Design Data: C Factors

	Slope Gradients (S)		
	≤ 3:1	3:1 – 2:1	≥ 2:1
Slope Length (L)	≤ 3:1	3:1 – 2:1	≥ 2:1
≤ 20 ft (6 m)	0.001	0.048	0.100
20-50 ft	0.051	0.079	0.145
≥ 50 ft (15.2 m)	0.10	0.110	0.190

NTPEP Large-Scale Slope
ASTM D6459 - C-factor = 0.031

Roughness Coefficients – Unveg.

Flow Depth	Manning's n
≤ 0.50 ft (0.15 m)	0.050
0.50 – 2.0 ft	0.050-0.018
≥ 2.0 ft (0.60 m)	0.018

Tensar
NORTH AMERICAN GREEN®

Tensar International Corporation
2500 Northwinds Parkway
Suite 500
Alpharetta, GA 30009
800-TENSAR-1
tensarcorp.com

Tensar International Corporation warrants that at the time of delivery the product furnished hereunder shall conform to the specification stated herein. Any other warranty including merchantability and fitness for a particular purpose, are hereby executed. If the product does not meet specifications on this page and Tensar is notified prior to installation, Tensar will replace the product at no cost to the customer. **This product specification supersedes all prior specifications for the product described above and is not applicable to any products shipped prior to January 1, 2012.**

©2013, Tensar International Corporation

EC_RMX_MPDS_ESC150_6.13



Specification Sheet – VMax® SC250® Turf Reinforcement Mat

DESCRIPTION

The composite turf reinforcement mat (C-TRM) shall be a machine-produced mat of 70% straw and 30% coconut fiber matrix incorporated into permanent three-dimensional turf reinforcement matting. The matrix shall be evenly distributed across the entire width of the matting and stitch bonded between a heavy duty UV stabilized nettings with 0.50 x 0.50 inch (1.27 x 1.27 cm) openings, an ultra heavy UV stabilized, dramatically corrugated (crimped) intermediate netting with 0.5 x 0.5 inch (1.27 x 1.27 cm) openings, and covered by an heavy duty UV stabilized nettings with 0.50 x 0.50 inch (1.27 x 1.27 cm) openings. The middle corrugated netting shall form prominent closely spaced ridges across the entire width of the mat. The three nettings shall be stitched together on 1.50 inch (3.81cm) centers with UV stabilized polypropylene thread to form permanent three-dimensional turf reinforcement matting. All mats shall be manufactured with a colored thread stitched along both outer edges as an overlap guide for adjacent mats.

The SC250 shall meet Type 5A, 5B, and 5C specification requirements established by the Erosion Control Technology Council (ECTC) and Federal Highway Administration's (FHWA) FP-03 Section 713.18

Material Content

Matrix	70% Straw Fiber	0.35 lb/sq yd (0.19 kg/sm)
	30% Coconut Fiber	0.15 lbs/sq yd (0.08 kg/sm)
Netting	Top and Bottom, UV-Stabilized Polypropylene	5 lb/1000 sq ft (2.44 kg/100 sm)
	Middle, Corrugated UV-Stabilized Polypropylene	24 lb/1000 sf (11.7 kg/100 sm)
Thread	Polypropylene, UV Stable	

Standard Roll Sizes

Width	6.5 ft (2.0 m)
Length	55.5 ft (16.9 m)
Weight ± 10%	34 lbs (15.42 kg)
Area	40 sq yd (33.4 sm)

Index Property	Test Method	Typical
Thickness	ASTM D6525	0.62 in. (15.75 mm)
Resiliency	ASTM 6524	95.2%
Density	ASTM D792	0.891 g/cm ³
Mass/Unit Area	ASTM 6566	16.13 oz/sy (548 g/sm)
UV Stability	ASTM D4355/ 1000 HR	100%
Porosity	ECTC Guidelines	99%
Stiffness	ASTM D1388	222.65 oz-in.
Light Penetration	ASTM D6567	4.1%
Tensile Strength - MD	ASTM D6818	709 lbs/ft (10.51 kN/m)
Elongation - MD	ASTM D6818	23.9%
Tensile Strength - TD	ASTM D6818	712 lbs/ft (10.56 kN/m)
Elongation - TD	ASTM D6818	36.9%
Biomass Improvement	ASTM D7322	441%

Design Permissible Shear Stress

	Short Duration	Long Duration
Phase 1: Unvegetated	3.0 psf (144 Pa)	2.5 psf (120 Pa)
Phase 2: Partially Veg.	8.0 psf (383 Pa)	8.0 psf (383 Pa)
Phase 3: Fully Veg.	10.0 psf (480 Pa)	8.0 psf (383 Pa)
Unvegetated Velocity	9.5 fps (2.9 m/s)	
Vegetated Velocity	15 fps (4.6 m/s)	

Slope Design Data: C Factors

Slope Length (L)	Slope Gradients (S)		
	≤ 3:1	3:1 - 2:1	≥ 2:1
≤ 20 ft (6 m)	0.0010	0.0209	0.0507
20-50 ft	0.0081	0.0266	0.0574
≥ 50 ft (15.2 m)	0.0455	0.0555	0.081

Roughness Coefficients – Unveg.

Flow Depth	Manning's n
≤ 0.50 ft (0.15 m)	0.040
0.50 – 2.0 ft	0.040-0.012
≥ 2.0 ft (0.60 m)	0.011

Tensar[®]

NORTH AMERICAN GREEN[®]

Tensar International Corporation
 2500 Northwinds Parkway
 Suite 500
 Alpharetta, GA 30009
 800-TENSAR-1
 tensarcorp.com

Tensar International Corporation warrants that at the time of delivery the product furnished hereunder shall conform to the specification stated herein. Any other warranty including merchantability and fitness for a particular purpose, are hereby executed. If the product does not meet specifications on this page and Tensar is notified prior to installation, Tensar will replace the product at no cost to the customer. **This product specification supersedes all prior specifications for the product described above and is not applicable to any products shipped prior to January 1, 2012.**

©2013, Tensar International Corporation

EC_RMX_MPDS_VMSC250_5.13



Specification Sheet – VMax® P550® Turf Reinforcement Mat

DESCRIPTION

The composite turf reinforcement mat (C-TRM) shall be a machine-produced mat of 100% UV stable polypropylene fiber matrix incorporated into permanent three-dimensional turf reinforcement matting. The matrix shall be evenly distributed across the entire width of the matting and stitch bonded between an ultra heavy duty UV stabilized nettings with 0.50 x 0.50 inch (1.27 x 1.27 cm) openings, an ultra heavy UV stabilized, dramatically corrugated (crimped) intermediate netting with 0.5 x 0.5 inch (1.27 x 1.27 cm) openings, and covered by an ultra heavy duty UV stabilized nettings with 0.50 x 0.50 inch (1.27 x 1.27 cm) openings. The middle corrugated netting shall form prominent closely spaced ridges across the entire width of the mat. The three nettings shall be stitched together on 1.50 inch (3.81cm) centers with UV stabilized polypropylene thread to form permanent three-dimensional turf reinforcement matting. All mats shall be manufactured with a colored thread stitched along both outer edges as an overlap guide for adjacent mats.

The P550 shall meet Type 5A, 5B, and 5C specification requirements established by the Erosion Control Technology Council (ECTC) and Federal Highway Administration's (FHWA) FP-03 Section 713.18

Material Content

Matrix	100% UV stable polypropylene fiber	0.5 lb/sy (0.27 kg/sm)
Netting	Top and Bottom, UV-Stabilized Polypropylene	24 lb/1000 sf (11.7 kg/100 sm)
	Middle, Corrugated UV-Stabilized Polypropylene	24 lb/1000 sf (11.7 kg/100 sm)
Thread	Polypropylene, UV Stable	

Standard Roll Sizes

Width	6.5 ft (2.0 m)
Length	55.5 ft (16.9 m)
Weight ± 10%	52 lbs (23.59 kg)
Area	40 sy (33.4 sm)

Index Property	Test Method	Typical
Thickness	ASTM D6525	0.72 in. (18.29 mm)
Resiliency	ASTM 6524	95%
Density	ASTM D792	0.892 g/cm ³
Mass/Unit Area	ASTM 6566	21.25 oz/sy (723 g/sm)
UV Stability	ASTM D4355/ 1000 HR	100%
Porosity	ECTC Guidelines	96%
Stiffness	ASTM D1388	366.3 oz-in.
Light Penetration	ASTM D6567	16.5%
Tensile Strength - MD	ASTM D6818	1421 lbs/ft (21.07 kN/m)
Elongation - MD	ASTM D6818	40.5%
Tensile Strength - TD	ASTM D6818	1191.6 lbs/ft (17.67 kN/m)
Elongation - TD	ASTM D6818	28.8%
Biomass Improvement	ASTM D7322	378%

Design Permissible Shear Stress

	Short Duration	Long Duration
Phase 1: Unvegetated	4.0 psf (191 Pa)	3.25 psf (156 Pa)
Phase 2: Partially Veg.	12.0 psf (576 Pa)	12.0 psf (576 Pa)
Phase 3: Fully Veg.	14.0 psf (672 Pa)	12.0 psf (576 Pa)
Unvegetated Velocity	12.5 fps (3.8 m/s)	
Vegetated Velocity	25 fps (7.6 m/s)	

NTPEP ASTM D6460 Large Scale Channel

Vegetated Shear Stress	>13.2 psf (632 Pa)
Vegetated Velocity	>24.5 fps (7.47 m/s)

Slope Design Data: C Factors

Slope Length (L)	Slope Gradients (S)		
	≤ 3:1	3:1 – 2:1	≥ 2:1
≤ 20 ft (6 m)	0.0005	0.015	0.043
20-50 ft	0.0173	0.031	0.050
≥ 50 ft (15.2 m)	0.035	0.047	0.057

Roughness Coefficients – Unveg.

Flow Depth	Manning's n
≤ 0.50 ft (0.15 m)	0.041
0.50 – 2.0 ft	0.040-0.013
≥ 2.0 ft (0.60 m)	0.013

Tensar[®]

NORTH AMERICAN GREEN[®]

Tensar International Corporation
 2500 Northwinds Parkway
 Suite 500
 Alpharetta, GA 30009
 800-TENSAR-1
 tensarcorp.com

Tensar International Corporation warrants that at the time of delivery the product furnished hereunder shall conform to the specification stated herein. Any other warranty including merchantability and fitness for a particular purpose, are hereby executed. If the product does not meet specifications on this page and Tensar is notified prior to installation, Tensar will replace the product at no cost to the customer. **This product specification supersedes all prior specifications for the product described above and is not applicable to any products shipped prior to January 1, 2012.**

©2013, Tensar International Corporation

EC_RMX_MPDS_VMP550_5.13

Filtrex[®] Runoff Diversion

Runoff & Erosion Control Technology

PURPOSE & DESCRIPTION

Filtrex[®] Runoff diversion is a three-dimensional tubular runoff and erosion control device used for diversion or redirection of runoff otherwise flowing to disturbed or highly erodible areas on and around construction activities. Filtrex[®] Runoff diversion can be used as temporary or permanent runoff diversion device used to prevent soil erosion during excavation, or prior to erosion control practice installation, vegetation establishment, or final stabilization.

APPLICATION

Filtrex[®] Runoff diversion is generally used upslope of areas undergoing excavation. Runoff diversion is effective at diverting sheet flow runoff coming from stabilized areas and otherwise flowing to unstable or bare soils while excavation and grading is in progress. Runoff diversion should direct runoff flows to stabilized channels, heavily vegetated areas, on to flat surfaces, infiltration zones, collection ponds, or storm inlets. Runoff diversion can also be used for temporary diversion on paved surfaces to protect disturbed soils adjacent to paved areas. Where hill slopes are greater than 5%, hydraulic shear stress is greater than 3 lbs/ft² (15 kg/m²), or runoff velocity is greater than 6 CFS (0.17 CMS) additional erosion control measures to help stabilize the area where flow is being directed and potentially concentrated or channeled should be utilized (KY TC, 2006). Filtrex[®] Channel protection may be used to stabilize channels where runoff is conveyed or concentrated. Runoff diversion devices and practices should be utilized early in the soil disturbance and construction process. Appropriate applications for runoff diversion devices include (Fifield, 2001):

- diversion of runoff away from disturbed areas and to stabilized outlets or storm inlets,
- diversion of sediment-laden water to a sediment containment or storm water treatment system,

- diversion of runoff into a conveyance channel to improve site working conditions (but does not otherwise increase erosion).
- prevention of sediment-laden runoff or storm water from leaving site perimeter.

For temporary applications, Runoff diversion does not need to be seeded; however, for permanent runoff diversion the device should be direct seeded at the time of application, as vegetation will prevent UV degradation of the device. Runoff diversion may also be used in sensitive environmental areas, where migration of wildlife may be impeded by the use of fences or trenching may damage plant roots.

It is possible to drive over Runoff diversion during construction; however, these areas should be immediately repaired by manually moving back into place, if disturbed. Continued heavy construction traffic may destroy the fabric, reduce the dimensions, and reduce the effectiveness of the Filtrex[®] Runoff diversion.

ADVANTAGES AND DISADVANTAGES

Advantages

- Runoff diversion can be used on hill slopes to divert storm water runoff and prevent soil erosion in unprotected or highly erodible soils.
- Tubular construction allows for heavier and denser barrier for added stability on slopes subject to storm water runoff flows.
- Greater surface area contact with soil than typical runoff control devices, reducing potential for runoff to create rills under the device.
- No trenching is required, therefore soil and plant roots are not disturbed upon installation.
- Runoff diversion can be installed year-round in difficult soil conditions such as frozen or wet ground, and dense and compacted soils,



as long as stakes can be driven.

- Runoff diversion is easily implemented as a treatment in a greater treatment train approach to any erosion and sediment control plan.
- Runoff diversion can be easily installed on top of rolled erosion control blankets, bonded fiber matrices, soil stabilizers, Slope protection, and Channel protection; or adjacent to rip rap.
- Soxx™ (mesh netting containment system) allow Runoff diversion to be placed in areas of high sheet flow and low concentrated flow, unlike conventional (lose) filter berms.
- Runoff diversion can be direct seeded at time of application to provide greater stability and anchoring once vegetation is established.
- Runoff diversion can be used as a temporary or permanent runoff and erosion control practice.
- GrowingMedia™ is organic and can be left on site after permanent stabilization is complete, used in landscape design, and/or seeded and planted with permanent vegetation.
- GrowingMedia™ improves existing soil structure if spread out and used as a soil amendment after construction activity is complete.
- Biodegradable Runoff diversion can be left on site after construction activity eliminating the need for removal and labor and disposal costs.
- Runoff diversion is less likely to obstruct wildlife movement and migration than planar/ fence runoff control devices.
- Runoff diversion is available in 8 in.(200mm), 12 in. (300mm), 18 in. (450mm), 24 in (600mm), and 32 in (800mm). diameters for customized applications and challenging

situations.

- Runoff diversion is available in 200 ft. (61 m) lengths to prevent weak sections and creation of concentrated flow situations typical to low points in runs of other runoff control devices. End points are sleeved together to create continuous unlimited lengths.
- Runoff diversion may assist in qualification for LEED® Green Building Rating and Certification credits under LEED® New Construction 2.2. Awarded credits may be possible from SS Prerequisite 1, SS Credit 5.1, MR Credit 4.1, MR Credit 4.2, MR Credit 5.1, MR Credit 5.2, and MR Credit 6. *Note: LEED® is an independent program offered through the US Green Building Council. LEED® credits are determined on a per project basis by an independent auditing committee. Filtrex® neither guarantees nor assures LEED® credits from the use of its products.*

Disadvantages

- If filler material of Runoff diversion is not GrowingMedia™, runoff diversion and/or vegetation growth may be diminished.
- If not installed correctly, maintained or used for a purpose or intention that does not meet specifications, performance may be diminished.
- If land surface is extremely bumpy, rocky, or changes elevation abruptly ground surface contact to Runoff diversion may be diminished, thereby adversely effecting performance.
- Runoff diversion should not be the only form of site erosion control.
- Runoff diversion should not be used for filtration of storm water runoff.
- Runoff diversion is not used for perimeter control of sediment.
- Runoff diversion should only be used on hill slopes and never in intermittent, ephemeral, or perennial streams.
- Runoff diversion which concentrate runoff flow may require additional erosion control or soil stabilization practices such as erosion control blankets, turf reinforcement mats, Filtrex® Channel protection, or rip rap.

MATERIAL SPECIFICATIONS

Filtrex® Runoff diversion use only photodegradable or biodegradable netting materials available from Filtrex® International, LLC and are the only mesh materials accepted in creating Filtrex® Runoff diver-

ADVANTAGES			
	LOW	MED	HIGH
Installation Difficulty	✓		
Durability			✓
Runoff Control		✓	
Erosion Control		✓	
Sediment Control		✓	
Soluble Pollutant Control		✓	



sion for any purpose. For Soxx™ Material Specifications see Table 6.1.

GROWINGMEDIA™ CHARACTERISTICS

Filtrexx® Runoff diversion typically use only Filtrexx® GrowingMedia™ which is a fine composted material that is specifically designed for diversion of storm water runoff, and establishment and sustainability of plant vegetation. At the discretion of the Engineer, soil or sand may be added to the GrowingMedia™ to add weight and ballast to the Runoff diversion. Performance parameters include: hydraulic flow-through rate, percent cover of vegetation, water holding capacity, pH, organic matter, soluble salts, moisture content, biological stability, percent inert material, bulk density and particle size distribution. For information on the physical, chemical, and biological properties of Filtrexx® GrowingMedia™ refer to Filtrexx® GrowingMedia™ Specifications in Appendix 5.26.

PERFORMANCE

Testing conducted at the Soil Control Lab, Inc. under simulated runoff conditions of sediment-laden water found that hydraulic flow-through rates for GrowingMedia™ used in Runoff diversion is less than 1 gpm/linear ft (1 L/min/m). Adding soil to the GrowingMedia™ may further reduce hydraulic flow-through rates. Field testing conducted by Filtrexx® International has shown that vegetation establishment can be near 100%. Figure 6.2 depicts a vegetated Runoff diversion.

For a summary of design specifications and performance testing results see Table 6.1 and Table 6.2 Note: the Contractor is responsible for establishing a working erosion and sediment control system and may, with approval of the Engineer, work outside the minimum construction requirements as needed. Where the Filtrexx® Runoff diversion deteriorates or fails, it shall be repaired or replaced with an effective alternative.

DESIGN CRITERIA

Runoff diversion is physical barriers designed to redirect or divert sheet flow runoff away from soil surfaces that have not been stabilized or are prone to water erosion. Runoff diversion should be used to intercept and convey runoff flows to non-erodible surfaces, drainage channels, or sediment ponds. This practice will prevent runoff from entering highly erodible areas and will reduce rill and gully erosion. For stabilized channel and drainage system specifications and design see Filtrexx® Channel

protection. Ultimately, runoff conveyance and drainage should lead to infiltration zones, heavily vegetated areas, or sediment/storm water treatment ponds.

To increase the weight of the Runoff diversion blending GrowingMedia™ with native soil and/or sand is acceptable. Blends should displace no more than 50% (by volume) of the GrowingMedia™ typically used within the Runoff diversion. Blends should consider the potential effects on vegetation if Runoff diversion will be seeded or used to support live stakes.

Design Height

A 4 in. (100mm) minimum vertical distance from the waterline to the top of the Runoff diversion (freeboard) is recommended. For most standard runoff diversion applications, a 18 in (450mm) diameter Runoff diversion is recommended (see Figure 6.1); however, where runoff flow may concentrate or sheet flow may be extreme a 24 in (600mm) or 32 in (800mm) diameter Runoff diversion may be used.

Three or more Runoff diversion Soxx™ may be stacked in a pyramid configuration to achieve a greater height or greater lateral stability, if desired (see Figure 6.1). Vegetation may be direct seeded at the time of installation resulting in enhanced performance and stability (see Figure 6.2 for an example). For a summary of specifications for product/practice use, performance and design see Table 6.1 and Table 6.2.

Slope Degree and Runoff Flow

Runoff diversion must be placed on slopes of at least 1% to effectively divert and convey runoff without ponding. If Runoff diversion is to be used on hill slopes greater than 5% soil stabilization or armoring practices may be necessary to prevent erosion from concentrated flows and/or conveyance channels. Concentrated runoff flows with hydraulic shear stress greater than 3 lbs/ft² (15 kg/m²) or velocity greater than 6 ft/sec (2 m/sec) should also use stabilization or armoring devices to prevent erosion. Runoff diversion should not be used on slopes steeper than 2:1. Runoff from undisturbed lands should be directed and discharged to an outlet that has been protected by approved practices such as Channel protection, rip rap or turf reinforcement mats. Sediment-laden runoff should be directed to a designed sediment containment or treatment system. Installation and utilization of runoff diversion devices should be done early in the construction process



(Fifield, 2001). Correct installation and maintenance is especially important for proper function and performance.

Land Placement:

Runoff diversion should be placed on smooth ground and even surfaces to prevent undercutting or excessive ponding and overtopping by runoff. Placing Runoff diversion on undisturbed soil will reduce the potential for undercutting.

Directing Flow:

In order to prevent water flowing around the ends of Runoff diversion, 5 ft (1.5m) of the end at highest elevation should be constructed pointing slightly upslope and into any existing vegetation. This will ensure runoff will flow along the down gradient of Runoff diversion.

The trailing edge of the device should point down slope to direct runoff flow to appropriate outlet, containment, or treatment systems already described.

Permanent Application: (Vegetated Filter Strip)

For permanent runoff control, Runoff diversion can be direct-seeded to allow vegetation to establish directly in the device, and seeding may be expanded to 5 ft (1.5m) upslope and downslope from the device, to increase performance. Vegetation on and around the Runoff diversion will assist in slowing runoff velocity, and increase the structural stability and anchoring of the device for long term use. Additionally, runoff control by the device may increase the stability and sustainability of plant establishment and growth where runoff is prone to destabilize vegetation. The option of adding vegetation will be at the discretion of the Engineer. No additional soil amendments or fertilizer are



24 in Runoff Diversion for High Storm Flow

required for vegetation establishment in the Runoff diversion. See Figure 6.2 for an example of a vegetated Runoff diversion.

INSTALLATION

1. Runoff diversion used for runoff and erosion control shall meet Filtrexx® FilterSoxx™ Material Specifications and use Filtrexx® GrowingMedia™. Soil and/or sand may be added to the Filtrexx® GrowingMedia™ at percent determined by the Engineer.
2. Contractor is required to be a Filtrexx® Certified™ Installer as determined by Filtrexx® International, LLC (440-926-2607 or visit website at Filtrexx.com). Certification shall be considered current if appropriate identification is shown during time of bid or at time of application (current list can be found at www.filtrexx.com). Look for the Filtrexx Certified™ Installer Seal.
3. Runoff diversion will be placed at locations indicated on plans as directed by the Engineer.
4. Runoff diversion shall be installed above and adjacent to areas of unprotected soil or areas prone to soil erosion.
5. Runoff diversion shall be installed where 5 ft (1.5m) of the end at highest elevation shall be constructed pointing slightly upslope and into any existing vegetation.
6. Runoff diversion shall be installed so trailing end of the device points down slope to prevent ponding of runoff.
7. Runoff diversion shall lead sheet and shallow concentrated runoff from vegetated/stabilized soil areas to stabilized channels, vegetated areas, level areas, high infiltration zones, or collection ponds.
8. Runoff diversion shall be placed on slopes 1% or greater to allow effective runoff conveyance and to prevent ponding.
9. Runoff diversion installed on slopes greater than 5% may require erosion control/soil stabilization practices where runoff flow is concentrated or conveyed.
10. Runoff diversion should not be used on slopes greater than 2:1.
11. Stakes shall be installed through the middle of the Runoff diversion on 10 ft (3m) centers, using 2 in (50mm) by 2 in (50mm) by 3 ft (1m) wooden stakes.
12. Staking depth for sand and silt loam soils shall



be 12 in (300mm), and 8 in (200mm) for clay soils.

13. If the Runoff diversion is to be a permanent runoff diversion device or part of the natural landscape, it may be seeded at time of installation for establishment of permanent vegetation. The Engineer will specify seed requirements.
14. Loose GrowingMedia[™] used for backfilling and extension of filter strip may also be seeded. The Engineer will specify seed requirements.

See design drawing details for correct Filtrex[®] Runoff diversion installation (Figure 6.1).

INSPECTION

Routine inspection should be conducted within 24 hrs of a runoff event or as designated by the regulating authority. Runoff diversion should be regularly inspected to make sure they maintain their shape and are adequately diverting storm runoff. If ponding becomes excessive, additional Runoff diversion may be required, sediment or debris removal may be necessary, or the device may need to be adjusted to allow gravitational flow of water down slope. A freeboard height of 4 in. (100mm) below the top edge of the device must be maintained at all times.

Runoff diversion shall be inspected until the entire area has been permanently stabilized and construction activity has ceased.

MAINTENANCE

1. The Contractor shall maintain the Runoff diversion in a functional condition at all times and it shall be routinely inspected.
2. If the Runoff diversion has been damaged, it shall be repaired, or replaced if beyond repair.
3. The Contractor shall remove sediment and debris at the base of the upslope side of the Runoff diversion when accumulation has reached 1/2 of the effective height of the Soxx[™] or as directed by the Engineer.
4. A freeboard height of 4 in. (100mm) below the top edge of the device must be maintained throughout the life of the device.
5. Runoff diversion shall be maintained until the hill slope has been permanently stabilized and construction activity has ceased.
6. The GrowingMedia[™] will be dispersed on site once disturbed area has been permanently stabilized, construction activity has ceased, or as determined by the Engineer.



Caption Please.

For runoff diversion and erosion control exceeding 1 year, Runoff diversion can be seeded at the time of installation to create a permanent runoff and erosion control system. Vegetation will add stability to the device and will reduce UV degradation of the system. The appropriate seed mix shall be determined by the Engineer.

DISPOSAL/RECYCLING

Filtrex[®] GrowingMedia[™] is an organic, composted product manufactured from locally generated organic, natural, and biologically based materials. Once all soil has been stabilized and construction activity has been completed, the GrowingMedia[™] may be dispersed with a loader, rake, bulldozer or similar device and may be incorporated into the soil as an amendment or left on the soil surface to aid in permanent seeding or landscaping. Leaving the GrowingMedia[™] on site reduces removal and disposal costs compared to other temporary runoff diversion devices. The mesh netting material will be extracted from the GrowingMedia[™] and disposed of properly by the Contractor. The mesh netting material is photodegradable and will decompose in 2 to 5 years if left on site. Biodegradable mesh netting material is available and does not need to be extracted and disposed of, as it will completely decompose in approximately 6 months. Using biodegradable Runoff diversion completely eliminates the need and cost of removal and disposal. As an alternative, vegetated Runoff diversion can be left on-site as permanent runoff diversion and erosion control devices used to redirect storm runoff and reduce stress from sheet flow on permanent vegetation.



METHOD OF MEASUREMENT

Bid items shall show measurement as 'X inch (X mm) diameter Filtrex[®] Runoff diversion per linear ft (linear meter), installed.

Engineer shall notify Filtrex[®] of location, description, and details of project prior to the bidding process so that Filtrex[®] can provide design aid and technical support.

REFERENCES CITED & ADDITIONAL RESOURCES

Faucette, L.B., K. Kerchner, and A. Vick. 2006. Sediment Storage Capacity of SiltSoxx[™] vs. Silt Fence. Filtrex[®] Tech Link #3314.

Faucette, L.B., H. Keener, M Klingman, and K. Kerchner. 2006. Design Capacity Prediction Tool for Silt Soxx[™] and Silt Fence. Filtrex[®] Tech Link #3313 (description) and Filtrex[®] Library #301 (design tool)

Faucette, L.B., and A. Vick. 2006. LEED Green Building Credits using Filtrex[®] Organic BMPs. Tech Link #3301.

Faucette, L.B. A. Vick, and K. Kerchner. 2006. Filtrex[®], Compost, Low Impact Development (LID), and Design Considerations for Storm Water Management. Tech Link #3306.

Faucette, L.B. 2006. Flow-Through Rate, Design Height, and Design Capacity of Silt Soxx[™] and Silt Fence. Tech Link #3304.

Faucette, L.B. 2006. Design Height, Flow-Through Rate, and Slope Spacing of SiltSoxx[™] and Silt Fence. Tech Link #3311.



Caption Please.

Faucette, L.B., and R. Tyler. 2006. Organic BMPs used for Storm Water Management. Proceedings of the International Erosion Control Association Annual Conference, Long Beach, CA 2006.

Faucette, B, F. Shields, and K. Kurtz. 2006. Removing storm water pollutants and determining relations between hydraulic flow-through rates, pollutant removal efficiency, and physical characteristics of compost filter media . Second Interagency Conference on Research in Watersheds, 2006 Proceedings. Coweeta Hydrologic Research Station, NC. Filtrex[®] Library #106.

Faucette, B., Sadeghi, A., K. Sefton. 2006. USDA ARS - Evaluation of Compost Filter Socks and Silt Fence in Sediment and Nutrient Reduction from Runoff. Filtrex[®] Tech Link #3308.

Faucette L.B., C.F. Jordan, L.M. Risse, M. Cabrera, D.C. Coleman, L.T. West. 2005.

Evaluation of Storm Water from Compost and Conventional Erosion Control Practices in Construction Activities. Journal of Soil and Water Conservation. 60:6:288-297.

Faucette, L.B. 2005. Removal and Degradation of Petroleum Hydrocarbons from Storm Water with Compost. Filtrex[®] Tech Link #3307.

Faucette, L.B. 2005. A Comparison of Performance and Test Methods of SiltSoxx[™] and Silt Fence. Filtrex[®] Tech Link #3302.

Faucette, L.B., N. Strazar, A. Marks. 2006. Filtrex[®] Polymer and Flocculent Guide. Filtrex[®] Library #601.

Fifield, J. 2001. Designing for Effective Sediment and Erosion Control on Construction Sites. Forester Press, Santa Barbara, CA.

Keener, H., B. Faucette, and M. Klingman. 2006. Flow-through rates and evaluation of solids separation of compost filter media vs. silt fence in sediment control applications. 2006 American Society of Agricultural and Biological Engineers Annual International Conference, Portland, OR. Paper No. 062060.

Marks, A., R. Tyler, and B. Faucette. 2005. The Filtrex[®] Library. Digital publication of



support tools for the erosion control industry.
www.Filtrexx@library.com.

Marks, A., and R. Tyler. 2003. Filtrexx® International Company Website. Specifications, CAD drawings, case histories. www.filtrexx.com.

Tyler, R.W., and A. Marks. 2004. Erosion Control Toolbox CD Kit. A Guide to Filtrexx® Products, Educational Supplement, and Project Videos. 3 CD set for Specifications and Design Considerations for Filtrexx® Products.

Tyler, R.W., J. Hoeck, and J. Giles. 2004. Keys to understanding how to use compost and organic matter. IECA Annual Meeting Presentations published as IECA Digital Education Library, Copyright 2004 Blue Sky Broadcast.

Tyler, R.W. 2004. International PCT Patent Publication #: WO 2004/002834 A2. Containment Systems, Methods and Devices for Controlling Erosion.

Tyler, R.W., A. Marks. 2003. Filtrexx® Product Installation Guide. Grafton, Ohio.

Tyler, R.W. 2003. International PCT Application #: PCTUS2003/020022. Containment Systems, Methods and Devices for Controlling Erosion.

Tyler, R.W. 2003. US Patent Publication #: 2003/0031511 A1. Devices, Systems and Methods for Controlling Erosion.

Tyler, R.W., and A. Marks. 2003. A Guide to Filtrexx® Products. Product Descriptions and Specifications for Filtrexx® Products.

Tyler, R.W., 2002. US Patent Application #10/208,631. Devices, Systems and Methods for Controlling Erosion.

Tyler, R.W. 2001. Provisional Patent Application #60/309,054. Devices, Systems and Methods for Controlling Erosion.

Tyler, R.W. 2001. Filtrexx® Product Manual. Specifications and Design Considerations for Filtrexx® Products, Grafton, OH.

Tyler, R.W. 1996. Winning the Organics Game – The Compost Marketers Handbook. ASHS Press,

ISBN # 0-9615027-2-x..

Tyler, R.W. 2007. US Patent # 7,226,240 “Devices, Systems and Methods for Controlling Erosion” Issue date 6-5-07.

US EPA NPDES Phase II. 2006. Compost Filter Socks: Construction Site Storm Water Runoff Control. National Menu of Best Management Practices for Construction Sites. http://cfpub.epa.gov/npdes/stormwater/menuofbmps/con_site.cfm

ADDITIONAL INFORMATION

For other references on this topic, including trade magazine and press coverage, visit the Filtrexx® Website at: <http://www.filtrexx.com/resourcespress.htm>.

For research reports not included in the Appendix, visit: <http://www.filtrexx.com/resourcesreports.htm>.

Filtrexx® International, LLC
Technical Support
35481 Grafton Eastern Rd
Grafton, OH 44044
440-926-2607
440-926-4021 (fax)
Website: www.filtrexx.com
Email: info@filtrexx.com

See website or call for complete list of international installers.

The information contained herein may be subject to confidential intellectual property of Filtrexx® International, LLC, including but not limited to US Patent 7,226,240 or Patents Pending and is the property of Filtrexx® International, LLC.

Unauthorized reproduction prohibited.
Filtrexx® is a Registered Trademark of Filtrexx® International, LLC.

Copyright 2009, Filtrexx® International, LLC, all rights reserved.



TABLES & FIGURES:

Table 6.1. Filtrex Soxx™ Material Specifications

Material Type	3 mil HDPE	5 mil HDPE	5 mil HDPE	Multi-Filament Polypropylene (MFPP)	Multi-Filament Polypropylene "SafetySoxx™"
Material Characteristic	Photodegradable	Photodegradable	Biodegradable	Photodegradable	Photodegradable
Design Diameters	5 in (125mm), 8 in (200mm), 12 in (300mm), 18 in (400mm)	5 in (125mm), 8 in (200mm), 12 in (300mm), 18 in (400mm), 24 in (600mm), 32 in (800mm)	8 in (200mm), 12 in (300mm), 18 in (400mm), 24 in (600mm), 32 in (800mm)	8 in (200mm), 12 in (300mm), 18 in (400mm), 24 in (600mm), 32 in (800mm)	8 in (200mm), 12 in (300mm), 18 in (400mm), 24 in (600mm), 32 in (800mm)
Mesh Opening	3/8 in (10mm)	3/8 in (10mm)	3/8 in (10mm)	3/8 in (10mm)	1/8 in (3mm)
Tensile Strength	ND	26 psi (1.83 kg/cm ²)	26 psi (1.83 kg/cm ²)	44 psi (3.09 kg/cm ²)	202 psi (14.2 kg/cm ²)*
Ultraviolet Stability % Original Strength (ASTM G-155)	23% at 1000 hr	23% at 1000 hr	ND	100% at 1000 hr	100% at 1000 hr
Functional Longevity/ Project Duration	6 mo-2 yr	9 mo-3 yr	6-12 months	1-4 yr	2-5 yr

* Tested at Texas Transportation Institute/Texas A&M University (ASTM 5035-95).

** Functional Longevity based on continual UV exposure without vegetation.
Once vegetation is established longevity of the system is greatly increased.



Table 6.2. Filtrex Runoff Diversion Performance and Design Specifications Summary

Design Diameter	8 in (200mm)	12 in (300mm)	18 in (450mm)	24 in (600mm)	32 in (800mm)	Testing Lab/ Reference	Publication(s)
Effective Height	6.5 in (160mm)	9.5 in (240mm)	14.5 in (360mm)	19 in (480mm)	26 in (650mm)	The Ohio State University, Ohio Agricultural Research and Development Center	Transactions of the American Society of Agricultural & Biological Engineers, 2006
Effective Circumference	25 in (630mm)	38 in (960mm)	57 in (1450mm)	75 in (1900mm)	100 in (2500mm)		
Density	20 lbs/ft (30 kg/m)	48 lbs/ft (73 kg/m)	110 lbs/ft (167 kg/m)	200 lbs/ft (300 kg/m)	300 lbs/ft (450 kg/m)	Filtrex International Field Lab	
Air Space	Testing in Progress	Testing in Progress	Testing in Progress	Testing in Progress	Testing in Progress	Soil Control Lab, Inc	
Maximum continuous length	unlimited	unlimited	unlimited	unlimited	unlimited		
Staking Requirement	10 ft (3m)	10 ft (3m)	10 ft (3m)	10 ft (3m)	10 ft (3m)		
Maintenance Requirement (sediment removal at X height)	3.25 in (80mm)	4.75 in (120mm)	7.25 in (180mm)	9.5 in (240mm)	13 in (325mm)		
Functional Longevity	2 – 5 yr	2 – 5 yr	2 – 5 yr	2 – 5 yr	2 – 5 yr	Filtrex International Field Lab	
Percent Vegetated Cover	Testing in Progress	Testing in Progress	Testing in Progress	Testing in Progress	Testing in Progress	Filtrex International Field Lab	
Hydraulic Flow Through Rate (sediment-laden water)	< 1 gpm /linear ft (<1 L /min/m)	< 1 gpm /linear ft (<1L/min/m)	< 1 gpm /linear ft (<1L/min/m)	< 1 gpm /linear ft (<1L/min/m)	< 1 gpm /linear ft (<1L/min/m)	Soil Control Lab, Inc	
Max Runoff Flow Height	3 in (75mm)	6 in (150mm)	11 in (275mm)	15 in (375mm)	22 in (550mm)	The Ohio State University, Ohio Agricultural Research and Development Center	Transactions of the American Society of Agricultural & Biological Engineers, 2006
Max Flow Velocity							





An Employee-Owned Company

APPENDIX B

Preparer Qualifications

**STANDARD E&S WORKSHEET # 22
 PLAN PREPARER RECORD OF TRAINING AND EXPERIENCE IN EROSION AND
 SEDIMENT POLLUTION CONTROL METHODS AND TECHNIQUES**

NAME OF PLAN PREPARER: Alaric J. Busher, PE, CPESC

FORMAL EDUCATION:

Name of College or Technical Institute: The Pennsylvania State University

Curriculum or Program: Civil Engineering

Dates of Attendance: **From:** 9/1995 **To:** 5/1999

Degree Received Bachelor of Science - Civil Engineering

OTHER TRAINING:

Name of Training:	<u>Annual Oil and Gas Training</u>	<u>Chapter 102 Update Training for the Regulated Community</u>
Presented By:	<u>PADEP</u>	<u>PADEP</u>
Date:	<u>7/10/2013</u>	<u>11/12/2010</u>

EMPLOYMENT HISTORY:

Current Employer: BL Companies

Telephone: 717-651-9850

Former Employer: N/A

Telephone: _____

RECENT E&S PLANS PREPARED:

Name of Project:	<u>Constitution Pipeline, Access Roads and Meter Station (ES, PCSM)</u>	<u>Reynolds Alford Pipeline (E&S, PCSM)</u>	<u>Annville Medical Office (E&S, PCSM)</u>
County:	<u>Susquehanna</u>	<u>Susquehanna</u>	<u>Lebanon</u>
Municipality:	<u>Multiple</u>	<u>Brooklyn, Harford</u>	<u>Annville Twp</u>
Permit Number:	<u>ESG0011540002</u>	<u>ESX13-115-0152(01)</u>	<u>PAG-02-0038-15-010</u>
Approving Agency:	<u>Susquehanna CCD</u>	<u>PADEP (O&G)</u>	<u>Lebanon CCD</u>

APPENDIX C

Site Characterization Assessment

RIVER ROAD REGULATOR STATION INFILTRATION RATE/DEWATERING TIME/TESTING METHODS

Infiltration testing data for the River Road Regulator Station site was provided by AECOM (TP-1 through TP-8) and BL Companies (BL-1 through BL-5). See Appendices. In accordance with Appendix C of the Pennsylvania Stormwater Best Management Practices Manual, a safety factor of 3 has been applied to the the infiltration rates measured at the site. The test numbers correspond to the test pit locations shown on the Post Construction Stormwater Management Plan. Tests performed by BL Companies used the double ring infiltrometer method. Tests performed by AECOM used the falling head procedure. The bentonite soak referred to by AECOM is to set the bentonite; the pre-soak is to establish saturated conditions at the test site.

Average/Stabilized reading

TP-1A	7.13	in/10 min. time interval
TP-1B	3.88	in/10 min. time interval
TP-2A-A	8.00	in/10 min. time interval
TP-2A-B	8.00	in/10 min. time interval
TP-3A-A	8.00	in/10 min. time interval
TP-3A-B	8.00	in/10 min. time interval
TP-8A	7.13	in/10 min. time interval
TP-8B	3.88	in/10 min. time interval
BL-1	0.94	in/10 min. time interval
BL-2	0.06	in/10 min. time interval
BL-3	1.75	in/10 min. time interval
BL-4	5.75	in/10 min. time interval
BL-5	5.75	in/10 min. time interval
Average drop	5.25	in/10 min. time interval

Adjusted Infiltration Rate

Average Infiltration Rate	31.50	in/hr
Safety factor	3.00	
Adjusted infiltration rate	10.50	in/hr

NOTE: In order to provide a more conservative estimate for design purposes the calculated infiltration rate shown above will be reduced to 0.50 in/hr.

The limiting layer depths range from 72 inches to 88 inches across the infiltration areas except for BL-1 through BL-5 in which no limiting layer was encountered. Bedrock was identified as the limiting layer. Most of the proposed infiltration elevations provide the recommended 24 inches of clearance to the limiting layer. In any area where bedrock is encountered within 2 feet of the final infiltration elevation, the bedrock will be removed and amended soil will be placed to provide the recommended buffer between the bedrock and infiltration surface. This will provide the recommended clearance to the limiting layer. As a result, it is our belief that the proposed design will meet the standards recommended in the PCSM Manual.

The drawdown time in the infiltration basins will be monitored. The soils within the basin will be amended if dewatering exceeds 72 hours (0.50 in/hr) or if the dewatering is greater than 10 in/hr. The minimum/design infiltration rate of 0.50 in/hr was derived by multiplying the minimum infiltration rate of 0.16 in/hr by a safety factor of 3. The 0.16 in/hr infiltration rate was calculated using the greatest ponding depth (12" in infiltration basin #2) and a maximum 72 hours dewatering time.

Soil Profile Log

Project 14C4909-A Atlantic Sunrise Project - River Road Regulator Station
 Test Pit # 1 **(BL1 ON PLAN SHEETS)**
 Name Krystal Bealing, CPSS
 Date June 17, 2016
 Weather Sunny, 66-80°F
 Equipment Mini Excavator

Elevation 597.88 AMSL
 Soil Type GbB - Glenelg silt loam, 3-8% slopes
 Geology Octoraro Formation
 Landscape Position/Slope Summit, 0-1% slope
 Land Use Disturbed woods
 Additional Notes Edge of woods and gravel road

Horizon	Depth (inches)	Texture	Coarse Fragments	Matrix Color	Color Patterns	Redoximorphic Features	Structure/Grade	Consistency	Boundary Strike/Dip	Roots/Pores	Depth to Bedrock	Depth to Water
A	0-4	Silt Loam	-	7.5YR 3/4	-	-	Granular, 2	Very Friable	Diffuse and Smooth	>20% roots	-	-
Bt1	4-18	Silt Clay Loam	15% Channery	7.5YR 4/6	-	-	Subangular Blocky, 1	Very Friable	Gradual and Wavy	>20% roots	-	-
Bt2	18-27	Silt Clay Loam	35% Channery	7.5YR 5/6	7.5YR 3/1	-	Platy, 1 parting to Subangular Blocky, 2	Very Friable	Diffuse and Smooth	2-20% roots	-	-
BC	27-41	Silt Clay Loam	50% Channery	7.5YR 3/4	-	-	Platy, 2 parting to Subangular Blocky, 1	Very Friable	Clear and Smooth	<2% roots	-	-
C	41-60+	Silt Clay Loam	60% Channery	7.5YR 4/4	-	-	Platy, 1	Very Friable	-	-	-	-

Comments: No limiting layer observed.

Soil Profile Log

Project 14C4909-A Atlantic Sunrise Project - River Road Regulator Station

Test Pit # 2 (**BL2 ON PLAN SHEETS**)

Name Krystal Bealing, CPSS

Date June 17, 2016

Weather Sunny, 66-80°F

Equipment Mini Excavator

Elevation 608-14 AMSL

Soil Type GbB - Glenelg silt loam, 3-8% slopes

Geology Octoraro Formation

Landscape Position/Slope Summit, 0-1% slope

Land Use Disturbed woods

Additional Notes Edge of woods and gravel road

Horizon	Depth (inches)	Texture	Coarse Fragments	Matrix Color	Color Patterns	Redoximorphic Features	Structure/Grade	Consistency	Boundary Strike/Dip	Roots/ Pores	Depth to Bedrock	Depth to Water
A	0-8	Silt Loam	5% Channery	7.5YR 3/4+	-	-	Granular, 1	Very Friable	Diffuse and Smooth	>20% roots	-	-
Bt	8-24	Silt Clay Loam	15% Channery	7.5YR 5/8	-	-	Subangular Blocky, 1	Very Friable	Clear and Smooth	>20% roots	-	-
BC	24-42	Silt Clay Loam	50% Channery	5YR 4/6	-	-	Platy, 2 parting to Subangular Blocky, 1	Very Friable	Clear and Smooth	2-20% roots	-	-
C	42-60+	Silt Clay Loam	60% Channery	7.5YR 4/6	-	-	Platy, 1	Very Friable	-	<2% roots	-	-

Comments: No limiting layer observed.

Soil Profile Log

Project 14C4909-A Atlantic Sunrise Project - River Road Regulator Station

Elevation 598.8 AMSL

Test Pit # 3 **(BL3 ON PLAN SHEETS)**

Soil Type GbB - Glenelg silt loam, 3-8% slopes

Name Krystal Bealing, CPSS

Geology Octoraro Formation

Date June 17, 2016

Landscape Position/Slope Summit, 0-1% slope

Weather Sunny, 66-80°F

Land Use Disturbed woods

Equipment Mini Excavator

Additional Notes Edge of woods and gravel road

Horizon	Depth (inches)	Texture	Coarse Fragments	Matrix Color	Color Patterns	Redoximorphic Features	Structure/Grade	Consistency	Boundary Strike/Dip	Roots/ Pores	Depth to Bedrock	Depth to Water
A	0-8	Silt Loam	10% Channery	7.5YR 3/4	-	-	Granular, 2	Very Friable	Clear and Smooth	>20% roots	-	-
Bt	8-18	Silt Clay Loam	25% Channery	7.5YR 4/6	-	-	Subangular Blocky, 1	Very Friable	Gradual and Wavy	>20% roots	-	-
BC	18-32	Silt Clay Loam	40% Channery	7.5YR 4/4	-	-	Platy, 2 parting to Subangular Blocky, 1	Very Friable	Clear and Smooth	2-20% roots	-	-
C	32-60	Silt Clay Loam	65% Channery	7.5YR 4/3	-	-	Platy, 1	Very Friable	-	<2% roots	-	-

Comments: No limiting layer observed.

Soil Profile Log

Project 14C4909-A Atlantic Sunrise Project - River Road Regulator Station

Test Pit # 4 (BL4 ON PLAN SHEETS)

Name Krystal Bealing, CPSS

Date June 17, 2016

Weather Sunny, 66-80°F

Equipment Mini Excavator

Elevation 599.52 AMSL

Soil Type GbB - Glenelg silt loam, 3-8% slopes

Geology Octoraro Formation

Landscape Position/Slope Summit, 0-1% slope

Land Use Disturbed woods

Additional Notes Edge of woods and gravel road

Horizon	Depth (inches)	Texture	Coarse Fragments	Matrix Color	Color Patterns	Redoximorphic Features	Structure/Grade	Consistency	Boundary Strike/Dip	Roots/ Pores	Depth to Bedrock	Depth to Water
A	0-6	Silt Loam	10% Channery	7.5YR 3/4	-	-	Granular, 2	Very Friable	Clear and Smooth	>20% roots	-	-
Bt	6-21	Silt Clay Loam	25% Channery	7.5YR 4/6	-	-	Subangular Blocky, 1	Very Friable	Gradual and Wavy	>20% roots	-	-
BC	21-42	Silt Clay Loam	40% Channery	7.5YR 4/4	-	-	Platy, 2 parting to Subangular Blocky, 1	Very Friable	Clear and Smooth	2-20% roots	-	-
C	42-60+	Silt Clay Loam	65% Channery	7.5YR 4/3	-	-	Platy, 1	Very Friable	-	<2% roots	-	-

Comments: No limiting layer observed.

Soil Profile Log

Project 14C4909-A Atlantic Sunrise Project - River Road Regulator Station

Test Pit # 5 **(BL5 ON PLAN SHEETS)**

Name Krystal Bealing, CPSS

Date June 17, 2016

Weather Sunny, 66-80°F

Equipment Mini Excavator

Elevation 607.84 AMSL

Soil Type GbB - Glenelg silt loam, 3-8% slopes

Geology Octoraro Formation

Landscape Position/Slope Summit, 0-1% slope

Land Use Disturbed woods

Additional Notes Edge of woods and gravel road

Horizon	Depth (inches)	Texture	Coarse Fragments	Matrix Color	Color Patterns	Redoximorphic Features	Structure/Grade	Consistency	Boundary Strike/Dip	Roots/ Pores	Depth to Bedrock	Depth to Water
A	0-10	Silt Loam	10% Channery	7.5YR 3/3	-	-	Granular, 2	Very Friable	Gradual and Smooth	>20% roots	-	-
Bt	10-28	Silt Clay Loam	15% Channery	7.5YR 5/8	-	-	Subangular Blocky, 2	Very Friable	Gradual and Smooth	>20% roots	-	-
BC	28-48	Silt Clay Loam	35% Channery	7.5YR 5/6	-	-	Platy, 2 parting to Subangular Blocky, 1	Very Friable	Gradual and Wavy	>20% roots	-	-
C	48-60+	Silt Clay Loam	50% Channery	7.5YR 5/6	-	-	Platy, 2	Very Friable	-	<2% roots	-	-

Comments: No limiting layer observed.

ATLANTIC SUNRISE PROJECT - RIVER ROAD REGULATOR STATION

SOIL INFILTRATION WORKSHEET - DOUBLE RING INFILTROMETER METHOD

Hole Number	Drop >2 inches after 30 minute presoak? ¹	Reading Interval (minutes)	Reading 1 (Inches of Drop)	Reading 2 (Inches of Drop)	Reading 3 (Inches of Drop)	Reading 4 (Inches of Drop)	Reading 5 (Inches of Drop)	Reading 6 (Inches of Drop)	Reading 7 (Inches of Drop)	Reading 8 (Inches of Drop)	Average Stabilized Reading ² (Inches of Drop)	Infiltration Rate ³ (in/hr)	Comments
BL1	Yes	10	0.938	0.938	1.125	1.000					1.000	6.000	66-80°F, sunny. Test done at 36 inches below the surface.
BL2	No	30	0.125	0.375	0.375	0.375					0.313	0.625	66-80°F, sunny. Test done at 36 inches below the surface.
BL3	Yes	10	4.750	1.750	5.750	2.750	5.750	3.250	3.000	4.375	3.922	23.531	66-80°F, sunny. Test done at 60 inches below the surface. Note: Readings 3 and 5 exceeded the limits of the infiltrometer and were empty of water within the 10 minute timeframe.
BL4	Yes	10	5.750	5.750	5.750	5.750					5.750	34.500	66-80°F, sunny. Test done at 60 inches below the surface. Note: All readings exceeded the limits of the infiltrometer and were empty of water within the 10 minute timeframe.
BL5	Yes	10	5.750	5.750	5.750	5.750					5.750	34.500	66-80°F, sunny. Test done at 36 inches below the surface. Note: All readings exceeded the limits of the infiltrometer and were empty of water within the 10 minute timeframe.

¹Inches of drop greater than 2 inches after the 2nd 30 minute presoak? Yes, use 10 minute interval; No, use 30 minute interval.

²Calculated as the average of the last four stabilized (less than 0.25-inch difference overall) readings, or an overall average in the case of eight unstabilized readings.

³Calculated as the average stabilized reading x 2 for 30 minute intervals; x 6 for 10 minute intervals.

Soil Profile Log

Project Williams- Rock Springs	Elevation Approx. 620 AMSL
Test Pit # 1	Soil Type Glenelg Silt Loam, 3-8% slopes
Name Logan Dunn	Geology Wissahickon Formation
Date February 25, 2015	Landscape Position/Slope Hilltop, 3-12%
Weather High 20s degrees F, ~5 MPH winds	Land Use Agriculture
Equipment CAT Excavator	Additional Comments No Redox Features Noted.

Horizon	Upper Boundary (inches)	Lower Boundary (inches)	Soil Textural Class	Type, Size, Coarse Fragments, etc.	Soil Matrix Color	Color Patterns	Pores, Roots, Structure	Depth to Bedrock	Depth to Water	Comments
A	0	10	L	Gravelly	7.5 YR 5/6	-	Few Roots Fine Pores Weak, Granular-Subangular blocky	-	-	Frozen, Friable
Bw1	10	19	CL	Gravelly	7.5 YR 5/8	-	Few Roots Medium Pores Moderate, Subangular blocky	-	-	Friable
Bw2	19	34	CL	Cobbly	7.5 YR 5/6	-	Few Roots Fine Pores Weak-moderate, Subangular blocky	-	-	Friable
C	34	72	L	Channery	7.5 YR 5/6	-	Few Roots Fine Pores Moderate, subangular blocky	-	-	Friable

Note: 1. Unless stated otherwise, horizon strike and dip was not observed to have a significant impact on water flow within the profile.

APPLICANT <i>Williams</i>	PROJECT NO.	DATE <i>2-25-15</i>
LOCATION <i>East Springs</i>	PREPARED BY <i>1 gya Duan</i>	
	PROBE NO. <i>TP-1</i>	

Hole Number	Time Interval (min)	Test Depth	Initial Water Depth inches	Presoak		Readings								
				1	2	1	2	3	4	5	6	7	8	9
TP-1A	10	4.0'	8'	Time 1120	1230	1230	1240	1250	1300	1310	1320	1330	1340	Amount of Drop
				Time 1150	1220	7 7/8"	7 7/8"	7 1/8"	7 1/4"	4"	3 7/8"	3 7/8"		
TP-1B	10	4.0'	8'	8" drop	8"	4 1/2"	4 1/2"	4 1/4"	4"	4"	3 7/8"	3 7/8"		

Be. hole size @ 1050

- If presoak drop is < 6" take readings every 30 minutes. If it is > 6" take readings every 10 minutes
 - 30 minute intervals: Minimum 2 hours of readings. Maximum of 4 hours
 - 10 minute intervals: Minimum of 80 minutes of readings, maximum of 80 mins
- The test shall continue at the interval determined until a minimum of eight readings are completed or until stabilized rate drop is obtained. Test is considered stable when 4 consecutive readings are with into 1/4".

13"
2 21"



Soil Profile Log

Project Williams- Rock Springs **Elevation** Approx. 620 AMSL
Test Pit # 2 **Soil Type** Glenelg Silt Loam, 3-8% slopes
Name Logan Dunn **Geology** Wissahickon Formation
Date February 25, 2015 **Landscape Position/Slope** Hilltop, 3-12%
Weather High 20s degrees F, ~5 MPH winds **Land Use** Agriculture
Equipment CAT Excavator **Additional Comments** No Infiltration Test Conducted- Rock (Schist) @ 82"
No Redox Features Noted.

Horizon	Upper Boundary (inches)	Lower Boundary (inches)	Soil Textural Class	Type, Size, Coarse Fragments, etc.	Soil Matrix Color	Color Patterns	Pores, Roots, Structure	Depth to Bedrock	Depth to Water	Comments
A	0	5	L	Gravelly	7.5 YR 4/4	-	Few Roots Medium Pores Weak, Granular	-	-	Friable
Bw1	5	11	CL	Gravelly-Cobbly	7.5 YR 5/8	-	Few Roots Medium Pores Moderate, Subangular blocky	-	-	Friable
Bw2	11	29	CL	Cobbly	7.5 YR 5/6	-	Few Roots Medium Pores Moderate, Subangular blocky	-	-	Friable
BE	29	62	L	Channery	7.5 YR 5/6	-	Few Roots Medium Pores Moderate, subangular blocky	-	-	Friable
C	62	82	L	Flaggy-Stony	7.5 YR 5/6	-	Few Roots Fine Pores Moderate, subangular blocky- Platy	-	-	Friable-Firm
R	82	104	Bedrock	-	-	-	-	82	-	Bedrock (Schist)

Note: 1. Unless stated otherwise, horizon strike and dip was not observed to have a significant impact on water flow within the profile.

Soil Profile Log

Project Williams- Rock Springs

Test Pit # 2A

Name Logan Dunn

Date February 27, 2015

Weather Mid 20s degrees F, ~7 MPH winds

Equipment CAT Excavator

Elevation Approx. 620 AMSL

Soil Type Glenelg Silt Loam, 3-8% slopes

Geology Wissahickon Formation

Landscape Position/Slope Hilltop, 3-12%

Land Use Agriculture

Additional Comments Rock Limiting Zone @ 84", Infiltration Test conducted @ 60"

No Redox Features Noted.

Horizon	Upper Boundary (inches)	Lower Boundary (inches)	Soil Textural Class	Type, Size, Coarse Fragments, etc.	Soil Matrix Color	Color Patterns	Pores, Roots, Structure	Depth to Bedrock	Depth to Water	Comments
A	0	6	L	Gravelly	7.5 YR 4/4	-	Weak, Granular	-	-	Friable
Bw1	6	17	CL	Gravelly	7.5 YR 5/8	-	Moderate, Subangular blocky	-	-	Friable
Bw2	17	34	CL	Cobbly	7.5 YR 5/6	-	Moderate, Subangular blocky	-	-	Friable
BE	34	64	L	Cobbly	7.5 YR 5/6	-	Moderate, subangular blocky	-	-	Friable
C	64	84	L	Channery	7.5 YR 5/6	-	Moderate, subangular blocky-Platy	-	-	Friable-Firm
R	84	-	Bedrock	-	-	-	-	84	-	Bedrock

Note: 1. Unless stated otherwise, horizon strike and dip was not observed to have a significant impact on water flow within the profile.

APPLICANT	W. J. Jones	PROJECT NO.	TP-2A	DATE	2-27-15
LOCATION	Back Spring	PROBE NO.	TP-2A	PREPARER	Logan Dumas

Hole Number	Time Interval (min)	Test Depth	Initial Water Depth	Presoak		Readings								
				1	2	1	2	3	4	5	6	7	8	9
TP-2A-A	10	5'	8"	1140	1210	1240	1300	1310	1320	1330	1340	1350	1400	9
				1210	1240	8"	8"	8"	8"	8"	8"	8"	8"	
TP-2A-B	10	5'	8"	8"	8"	8"	8"	8"	8"	8"	8"	8"	8"	9

Base Point P. 1110

- * If presoak drop is < 6" take readings every 30 minutes. If it is > 6" take readings every 10 minutes
- * 30 minute intervals: Minimum 2 hours of readings. Maximum of 4 hours
- * 10 minute intervals: Minimum of 80 minutes of readings, maximum of 80 mins

The test shall continue at the interval determined until a minimum of eight readings are completed or until stabilized rate drop is obtained. Test is considered stable when 4 consecutive readings are with into 1/4".

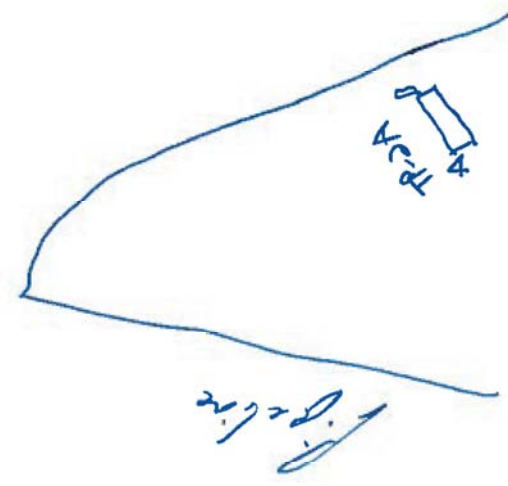

Soil Profile Log

Project Williams- Rock Springs	Elevation Approx. 620 AMSL
Test Pit # 3A	Soil Type Glenelg Silt Loam, 3-8% slopes
Name Logan Dunn	Geology Wissahickon Formation
Date February 27, 2015	Landscape Position/Slope Hilltop, 3-12%
Weather Mid 20s degrees F, ~7 MPH winds	Land Use Agriculture
Equipment CAT Excavator	Additional Comments Competent Rock @ 88", Infiltration Test conducted @ 64" No Redox Features Noted.

Horizon	Upper Boundary (inches)	Lower Boundary (inches)	Soil Textural Class	Type, Size, Coarse Fragments, etc.	Soil Matrix Color	Color Patterns	Pores, Roots, Structure	Depth to Bedrock	Depth to Water	Comments
A	0	7	L	Gravelly	7.5 YR 4/4	-	Few Roots Medium Pores Weak, Granular	-	-	Frozen, Friable
Bw1	7	18	CL	Gravelly	7.5 YR 5/8	-	Few Roots Medium Pores Moderate, Subangular blocky	-	-	Friable
Bw2	18	32	CL	Cobbly	7.5 YR 5/6	-	Few Roots Fine Pores Moderate, Subangular blocky	-	-	Friable
BE	32	45	L	Cobbly-Channery	7.5 YR 5/6	-	Few Roots Fine Pores Moderate, subangular blocky	-	-	Friable
C	45	88	L	Channery	7.5 YR 5/6	-	Few Roots Pores Moderate, subangular blocky- Platy	-	-	Friable-Firm
R	88	-	Bedrock	-	-	-	-	88	-	Bedrock (Schist)

Note: 1. Unless stated otherwise, horizon strike and dip was not observed to have a significant impact on water flow within the profile.

APPLICANT		PROJECT NO.		DATE															
LOCATION		PROBE NO.		PREPARER															
Williams Rock Springs		TP-3A		Loren Dean															
Hole Number	Time Interval (min)	Test Depth	Initial Water Depth	Readings															
				1		2		3		4		5		6		7		8	
				Time															
				1125	1155	1225	1235	1245	1255	1305	1315	1325	1335	1345					
TP3A-A	10	64"	8"	8"	8"	8"	8"	8"	8"	8"	8"	8"	8"	8"					
TP3A-B	10	64"	8"	8"	8"	8"	8"	8"	8"	8"	8"	8"	8"	8"					

Ben harte presoak @ 1055

* If presoak drop is < 6" take readings every 30 minutes. If it is > 6" take readings every 10 minutes

* 30 minute intervals: Minimum 2 hours of readings. Maximum of 4 hours

* 10 minute intervals: Minimum of 80 minutes of readings, maximum of 80 mins

The test shall continue at the interval determined until a minimum of eight readings are completed or until stabilized rate drop is obtained. Test is considered stable when 4 consecutive readings are with into 1/4".



Soil Profile Log

Project Williams- Rock Springs
 Test Pit # 8
 Name Logan Dunn
 Date February 27, 2015
 Weather Mid 20s degrees F, ~7 MPH winds
 Equipment CAT Excavator

Elevation Approx. 620 AMSL
 Soil Type Glennelg Silt Loam, 3-8% slopes
 Geology Wissahickon Formation
 Landscape Position/Slope Hilltop, 3-12%
 Land Use Agriculture
 Additional Comments Competent Rock @ 72", Infiltration Test conducted @ 48"
No Redox Features Noted.

Horizon	Upper Boundary (inches)	Lower Boundary (inches)	Soil Textural Class	Type, Size, Coarse Fragments, etc.	Soil Matrix Color	Color Patterns	Pores, Roots, Structure	Depth to Bedrock	Depth to Water	Comments
A	0	7	L	Gravelly	7.5 YR 4/4	-	Few Roots Medium Pores Weak, Granular	-	-	Frozen, Friable
Bw1	7	17	CL	Gravelly	7.5 YR 5/8	-	Few Roots Moderate, Subangular blocky	-	-	Friable
Bw2	17	31	CL	Cobbly	7.5 YR 5/6	-	Few Roots Fine Pores Moderate, Subangular blocky	-	-	Friable
C	31	72	L	Cobbly- Channery	7.5 YR 5/6	-	Few Roots Fine Pores Moderate, subangular blocky- platy	-	-	Friable-Firm
R	72	-	Bedrock	-	-	-	-	72	-	Bedrock

Note: 1. Unless stated otherwise, horizon strike and dip was not observed to have a significant impact on water flow within the profile.

APPLICANT		PROJECT NO.		DATE									
LOCATION		PROBE NO.		PREPARER									
Williams		TA-8		2-27-15									
Rock Spring		TA-8		Logan Dur									
Hole Number	Time Interval (min)	Test Depth	Initial Water Depth	Readings									
				1	2	3	4	5	6	7	8	9	
TP-8A	10	4'	8"	1148	1248	1308	1308	1328	1328	1348	1358	1406	
				1218	1248	1308	1308	1328	1348	1358	1406		
TP-8B	10	4'	8"	1218	1248	1308	1308	1328	1328	1348	1358	1406	
				1218	1248	1308	1308	1328	1348	1358	1406		

Baker Presoak @ 1118

* If presoak drop is < 6" take readings every 30 minutes. If it is > 6" take readings every 10 minutes

* 30 minute intervals: Minimum 2 hours of readings. Maximum of 4 hours

* 10 minute intervals: Minimum of 80 minutes of readings, maximum of 80 mins

The test shall continue at the interval determined until a minimum of eight readings are completed or until stabilized rate drop is obtained. Test is considered stable when 4 consecutive readings are with into 1/4".

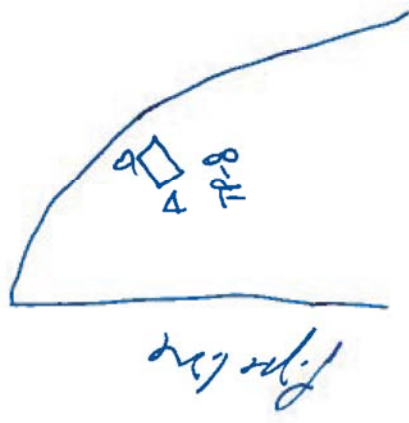



An Employee-Owned Company

APPENDIX D

United States Department of Agriculture (USDA) Natural Resources Conservation Service (NRCS) Custom Soil Resource Report

Custom Soil Resource Report for Lancaster County, Pennsylvania

River Road Regulator Station



Preface

Soil surveys contain information that affects land use planning in survey areas. They highlight soil limitations that affect various land uses and provide information about the properties of the soils in the survey areas. Soil surveys are designed for many different users, including farmers, ranchers, foresters, agronomists, urban planners, community officials, engineers, developers, builders, and home buyers. Also, conservationists, teachers, students, and specialists in recreation, waste disposal, and pollution control can use the surveys to help them understand, protect, or enhance the environment.

Various land use regulations of Federal, State, and local governments may impose special restrictions on land use or land treatment. Soil surveys identify soil properties that are used in making various land use or land treatment decisions. The information is intended to help the land users identify and reduce the effects of soil limitations on various land uses. The landowner or user is responsible for identifying and complying with existing laws and regulations.

Although soil survey information can be used for general farm, local, and wider area planning, onsite investigation is needed to supplement this information in some cases. Examples include soil quality assessments (<http://www.nrcs.usda.gov/wps/portal/nrcs/main/soils/health/>) and certain conservation and engineering applications. For more detailed information, contact your local USDA Service Center (<http://offices.sc.egov.usda.gov/locator/app?agency=nrcs>) or your NRCS State Soil Scientist (http://www.nrcs.usda.gov/wps/portal/nrcs/detail/soils/contactus/?cid=nrcs142p2_053951).

Great differences in soil properties can occur within short distances. Some soils are seasonally wet or subject to flooding. Some are too unstable to be used as a foundation for buildings or roads. Clayey or wet soils are poorly suited to use as septic tank absorption fields. A high water table makes a soil poorly suited to basements or underground installations.

The National Cooperative Soil Survey is a joint effort of the United States Department of Agriculture and other Federal agencies, State agencies including the Agricultural Experiment Stations, and local agencies. The Natural Resources Conservation Service (NRCS) has leadership for the Federal part of the National Cooperative Soil Survey.

Information about soils is updated periodically. Updated information is available through the NRCS Web Soil Survey, the site for official soil survey information.

The U.S. Department of Agriculture (USDA) prohibits discrimination in all its programs and activities on the basis of race, color, national origin, age, disability, and where applicable, sex, marital status, familial status, parental status, religion, sexual orientation, genetic information, political beliefs, reprisal, or because all or a part of an individual's income is derived from any public assistance program. (Not all prohibited bases apply to all programs.) Persons with disabilities who require alternative means

for communication of program information (Braille, large print, audiotape, etc.) should contact USDA's TARGET Center at (202) 720-2600 (voice and TDD). To file a complaint of discrimination, write to USDA, Director, Office of Civil Rights, 1400 Independence Avenue, S.W., Washington, D.C. 20250-9410 or call (800) 795-3272 (voice) or (202) 720-6382 (TDD). USDA is an equal opportunity provider and employer.

Contents

Preface	2
How Soil Surveys Are Made	5
Soil Map	7
Soil Map.....	8
Legend.....	9
Map Unit Legend.....	10
Map Unit Descriptions.....	10
Lancaster County, Pennsylvania.....	12
CbB—Chester silt loam, 3 to 8 percent slopes.....	12
GbB—Gleneig silt loam, 3 to 8 percent slopes.....	13
MbD—Manor very stony silt loam, 8 to 25 percent slopes.....	14
References	16

How Soil Surveys Are Made

Soil surveys are made to provide information about the soils and miscellaneous areas in a specific area. They include a description of the soils and miscellaneous areas and their location on the landscape and tables that show soil properties and limitations affecting various uses. Soil scientists observed the steepness, length, and shape of the slopes; the general pattern of drainage; the kinds of crops and native plants; and the kinds of bedrock. They observed and described many soil profiles. A soil profile is the sequence of natural layers, or horizons, in a soil. The profile extends from the surface down into the unconsolidated material in which the soil formed or from the surface down to bedrock. The unconsolidated material is devoid of roots and other living organisms and has not been changed by other biological activity.

Currently, soils are mapped according to the boundaries of major land resource areas (MLRAs). MLRAs are geographically associated land resource units that share common characteristics related to physiography, geology, climate, water resources, soils, biological resources, and land uses (USDA, 2006). Soil survey areas typically consist of parts of one or more MLRA.

The soils and miscellaneous areas in a survey area occur in an orderly pattern that is related to the geology, landforms, relief, climate, and natural vegetation of the area. Each kind of soil and miscellaneous area is associated with a particular kind of landform or with a segment of the landform. By observing the soils and miscellaneous areas in the survey area and relating their position to specific segments of the landform, a soil scientist develops a concept, or model, of how they were formed. Thus, during mapping, this model enables the soil scientist to predict with a considerable degree of accuracy the kind of soil or miscellaneous area at a specific location on the landscape.

Commonly, individual soils on the landscape merge into one another as their characteristics gradually change. To construct an accurate soil map, however, soil scientists must determine the boundaries between the soils. They can observe only a limited number of soil profiles. Nevertheless, these observations, supplemented by an understanding of the soil-vegetation-landscape relationship, are sufficient to verify predictions of the kinds of soil in an area and to determine the boundaries.

Soil scientists recorded the characteristics of the soil profiles that they studied. They noted soil color, texture, size and shape of soil aggregates, kind and amount of rock fragments, distribution of plant roots, reaction, and other features that enable them to identify soils. After describing the soils in the survey area and determining their properties, the soil scientists assigned the soils to taxonomic classes (units). Taxonomic classes are concepts. Each taxonomic class has a set of soil characteristics with precisely defined limits. The classes are used as a basis for comparison to classify soils systematically. Soil taxonomy, the system of taxonomic classification used in the United States, is based mainly on the kind and character of soil properties and the arrangement of horizons within the profile. After the soil scientists classified and named the soils in the survey area, they compared the

Custom Soil Resource Report

individual soils with similar soils in the same taxonomic class in other areas so that they could confirm data and assemble additional data based on experience and research.

The objective of soil mapping is not to delineate pure map unit components; the objective is to separate the landscape into landforms or landform segments that have similar use and management requirements. Each map unit is defined by a unique combination of soil components and/or miscellaneous areas in predictable proportions. Some components may be highly contrasting to the other components of the map unit. The presence of minor components in a map unit in no way diminishes the usefulness or accuracy of the data. The delineation of such landforms and landform segments on the map provides sufficient information for the development of resource plans. If intensive use of small areas is planned, onsite investigation is needed to define and locate the soils and miscellaneous areas.

Soil scientists make many field observations in the process of producing a soil map. The frequency of observation is dependent upon several factors, including scale of mapping, intensity of mapping, design of map units, complexity of the landscape, and experience of the soil scientist. Observations are made to test and refine the soil-landscape model and predictions and to verify the classification of the soils at specific locations. Once the soil-landscape model is refined, a significantly smaller number of measurements of individual soil properties are made and recorded. These measurements may include field measurements, such as those for color, depth to bedrock, and texture, and laboratory measurements, such as those for content of sand, silt, clay, salt, and other components. Properties of each soil typically vary from one point to another across the landscape.

Observations for map unit components are aggregated to develop ranges of characteristics for the components. The aggregated values are presented. Direct measurements do not exist for every property presented for every map unit component. Values for some properties are estimated from combinations of other properties.

While a soil survey is in progress, samples of some of the soils in the area generally are collected for laboratory analyses and for engineering tests. Soil scientists interpret the data from these analyses and tests as well as the field-observed characteristics and the soil properties to determine the expected behavior of the soils under different uses. Interpretations for all of the soils are field tested through observation of the soils in different uses and under different levels of management. Some interpretations are modified to fit local conditions, and some new interpretations are developed to meet local needs. Data are assembled from other sources, such as research information, production records, and field experience of specialists. For example, data on crop yields under defined levels of management are assembled from farm records and from field or plot experiments on the same kinds of soil.

Predictions about soil behavior are based not only on soil properties but also on such variables as climate and biological activity. Soil conditions are predictable over long periods of time, but they are not predictable from year to year. For example, soil scientists can predict with a fairly high degree of accuracy that a given soil will have a high water table within certain depths in most years, but they cannot predict that a high water table will always be at a specific level in the soil on a specific date.

After soil scientists located and identified the significant natural bodies of soil in the survey area, they drew the boundaries of these bodies on aerial photographs and identified each as a specific map unit. Aerial photographs show trees, buildings, fields, roads, and rivers, all of which help in locating boundaries accurately.

Soil Map

The soil map section includes the soil map for the defined area of interest, a list of soil map units on the map and extent of each map unit, and cartographic symbols displayed on the map. Also presented are various metadata about data used to produce the map, and a description of each soil map unit.

Custom Soil Resource Report Soil Map



Map Scale: 1:852 if printed on A landscape (11" x 8.5") sheet.



Map projection: Web Mercator Corner coordinates: WGS84 Edge tics: UTM Zone 18N WGS84



MAP INFORMATION

The soil surveys that comprise your AOI were mapped at 1:15,800.

Warning: Soil Map may not be valid at this scale.

Enlargement of maps beyond the scale of mapping can cause misunderstanding of the detail of mapping and accuracy of soil line placement. The maps do not show the small areas of contrasting soils that could have been shown at a more detailed scale.

Please rely on the bar scale on each map sheet for map measurements.

Source of Map: Natural Resources Conservation Service
 Web Soil Survey URL: <http://websoilsurvey.nrcs.usda.gov>
 Coordinate System: Web Mercator (EPSG:3857)

Maps from the Web Soil Survey are based on the Web Mercator projection, which preserves direction and shape but distorts distance and area. A projection that preserves area, such as the Albers equal-area conic projection, should be used if more accurate calculations of distance or area are required.

This product is generated from the USDA-NRCS certified data as of the version date(s) listed below.





































Soil Survey Area: Lancaster County, Pennsylvania
 Survey Area Data: Version 10, Sep 19, 2014

Soil map units are labeled (as space allows) for map scales 1:50,000 or larger.

Date(s) aerial images were photographed: Mar 26, 2011—Mar 2, 2012

The orthophoto or other base map on which the soil lines were compiled and digitized probably differs from the background imagery displayed on these maps. As a result, some minor shifting of map-unit boundaries may be evident.

MAP LEGEND

 Area of Interest (AOI)	 Spoil Area
 Soil Map Unit Polygons	 Stony Spot
 Soil Map Unit Lines	 Very Stony Spot
 Soil Map Unit Points	 Wet Spot
 Special Point Features	 Other
 Blowout	 Special Line Features
 Borrow Pit	Water Features
 Clay Spot	 Streams and Canals
 Closed Depression	Transportation
 Gravel Pit	 Rails
 Gravelly Spot	 Interstate Highways
 Landfill	 US Routes
 Lava Flow	 Major Roads
 Marsh or swamp	 Local Roads
 Mine or Quarry	Background
 Miscellaneous Water	 Aerial Photography
 Perennial Water	
 Rock Outcrop	
 Saline Spot	
 Sandy Spot	
 Severely Eroded Spot	
 Sinkhole	
 Slide or Slip	
 Sodic Spot	

Map Unit Legend

Lancaster County, Pennsylvania (PA071)			
Map Unit Symbol	Map Unit Name	Acres in AOI	Percent of AOI
CbB	Chester silt loam, 3 to 8 percent slopes	0.0	0.2%
GbB	Glenelg silt loam, 3 to 8 percent slopes	2.1	75.3%
MbD	Manor very stony silt loam, 8 to 25 percent slopes	0.7	24.5%
Totals for Area of Interest		2.8	100.0%

Map Unit Descriptions

The map units delineated on the detailed soil maps in a soil survey represent the soils or miscellaneous areas in the survey area. The map unit descriptions, along with the maps, can be used to determine the composition and properties of a unit.

A map unit delineation on a soil map represents an area dominated by one or more major kinds of soil or miscellaneous areas. A map unit is identified and named according to the taxonomic classification of the dominant soils. Within a taxonomic class there are precisely defined limits for the properties of the soils. On the landscape, however, the soils are natural phenomena, and they have the characteristic variability of all natural phenomena. Thus, the range of some observed properties may extend beyond the limits defined for a taxonomic class. Areas of soils of a single taxonomic class rarely, if ever, can be mapped without including areas of other taxonomic classes. Consequently, every map unit is made up of the soils or miscellaneous areas for which it is named and some minor components that belong to taxonomic classes other than those of the major soils.

Most minor soils have properties similar to those of the dominant soil or soils in the map unit, and thus they do not affect use and management. These are called noncontrasting, or similar, components. They may or may not be mentioned in a particular map unit description. Other minor components, however, have properties and behavioral characteristics divergent enough to affect use or to require different management. These are called contrasting, or dissimilar, components. They generally are in small areas and could not be mapped separately because of the scale used. Some small areas of strongly contrasting soils or miscellaneous areas are identified by a special symbol on the maps. If included in the database for a given area, the contrasting minor components are identified in the map unit descriptions along with some characteristics of each. A few areas of minor components may not have been observed, and consequently they are not mentioned in the descriptions, especially where the pattern was so complex that it was impractical to make enough observations to identify all the soils and miscellaneous areas on the landscape.

The presence of minor components in a map unit in no way diminishes the usefulness or accuracy of the data. The objective of mapping is not to delineate pure taxonomic classes but rather to separate the landscape into landforms or landform segments that have similar use and management requirements. The delineation of such segments

Custom Soil Resource Report

on the map provides sufficient information for the development of resource plans. If intensive use of small areas is planned, however, onsite investigation is needed to define and locate the soils and miscellaneous areas.

An identifying symbol precedes the map unit name in the map unit descriptions. Each description includes general facts about the unit and gives important soil properties and qualities.

Soils that have profiles that are almost alike make up a *soil series*. Except for differences in texture of the surface layer, all the soils of a series have major horizons that are similar in composition, thickness, and arrangement.

Soils of one series can differ in texture of the surface layer, slope, stoniness, salinity, degree of erosion, and other characteristics that affect their use. On the basis of such differences, a soil series is divided into *soil phases*. Most of the areas shown on the detailed soil maps are phases of soil series. The name of a soil phase commonly indicates a feature that affects use or management. For example, Alpha silt loam, 0 to 2 percent slopes, is a phase of the Alpha series.

Some map units are made up of two or more major soils or miscellaneous areas. These map units are complexes, associations, or undifferentiated groups.

A *complex* consists of two or more soils or miscellaneous areas in such an intricate pattern or in such small areas that they cannot be shown separately on the maps. The pattern and proportion of the soils or miscellaneous areas are somewhat similar in all areas. Alpha-Beta complex, 0 to 6 percent slopes, is an example.

An *association* is made up of two or more geographically associated soils or miscellaneous areas that are shown as one unit on the maps. Because of present or anticipated uses of the map units in the survey area, it was not considered practical or necessary to map the soils or miscellaneous areas separately. The pattern and relative proportion of the soils or miscellaneous areas are somewhat similar. Alpha-Beta association, 0 to 2 percent slopes, is an example.

An *undifferentiated group* is made up of two or more soils or miscellaneous areas that could be mapped individually but are mapped as one unit because similar interpretations can be made for use and management. The pattern and proportion of the soils or miscellaneous areas in a mapped area are not uniform. An area can be made up of only one of the major soils or miscellaneous areas, or it can be made up of all of them. Alpha and Beta soils, 0 to 2 percent slopes, is an example.

Some surveys include *miscellaneous areas*. Such areas have little or no soil material and support little or no vegetation. Rock outcrop is an example.

Lancaster County, Pennsylvania

CbB—Chester silt loam, 3 to 8 percent slopes

Map Unit Setting

National map unit symbol: 2tt7y
Elevation: 10 to 1,170 feet
Mean annual precipitation: 40 to 55 inches
Mean annual air temperature: 48 to 57 degrees F
Frost-free period: 150 to 192 days
Farmland classification: All areas are prime farmland

Map Unit Composition

Chester and similar soils: 80 percent
Minor components: 20 percent
Estimates are based on observations, descriptions, and transects of the mapunit.

Description of Chester

Setting

Landform: Hillslopes
Landform position (two-dimensional): Summit
Landform position (three-dimensional): Interfluve
Down-slope shape: Linear, convex
Across-slope shape: Linear, convex
Parent material: Residuum weathered from mica schist

Typical profile

Ap - 0 to 10 inches: silt loam
BE - 10 to 17 inches: silt loam
Bt1 - 17 to 22 inches: clay loam
Bt2 - 22 to 30 inches: clay loam
Bt3 - 30 to 38 inches: clay loam
Bt4 - 38 to 56 inches: loam
C - 56 to 92 inches: fine sandy loam

Properties and qualities

Slope: 3 to 8 percent
Depth to restrictive feature: More than 80 inches
Natural drainage class: Well drained
Capacity of the most limiting layer to transmit water (Ksat): Moderately high to high
(0.57 to 1.98 in/hr)
Depth to water table: More than 80 inches
Frequency of flooding: None
Frequency of ponding: None
Available water storage in profile: High (about 9.9 inches)

Interpretive groups

Land capability classification (irrigated): None specified
Land capability classification (nonirrigated): 2e
Hydrologic Soil Group: B

Minor Components

Glenville

Percent of map unit: 10 percent

Custom Soil Resource Report

Landform: Hillslopes
Landform position (two-dimensional): Footslope, toeslope
Landform position (three-dimensional): Head slope
Down-slope shape: Linear
Across-slope shape: Concave

Mt. airy

Percent of map unit: 5 percent
Landform: Hillslopes
Landform position (two-dimensional): Summit, shoulder
Landform position (three-dimensional): Nose slope, crest, side slope
Down-slope shape: Convex
Across-slope shape: Convex

Gladstone

Percent of map unit: 5 percent
Landform: Hillslopes
Landform position (two-dimensional): Shoulder, backslope, summit
Landform position (three-dimensional): Interfluve
Down-slope shape: Linear, convex
Across-slope shape: Convex, linear

GbB—Glenelg silt loam, 3 to 8 percent slopes

Map Unit Setting

National map unit symbol: 16s3
Elevation: 200 to 2,000 feet
Mean annual precipitation: 40 to 55 inches
Mean annual air temperature: 45 to 61 degrees F
Frost-free period: 110 to 235 days
Farmland classification: All areas are prime farmland

Map Unit Composition

Glenelg and similar soils: 92 percent
Minor components: 8 percent
Estimates are based on observations, descriptions, and transects of the mapunit.

Description of Glenelg

Setting

Landform: Hillslopes
Landform position (two-dimensional): Summit, shoulder, backslope
Landform position (three-dimensional): Interfluve, side slope, nose slope
Down-slope shape: Linear, convex
Across-slope shape: Convex, linear
Parent material: Residuum weathered from mica schist

Typical profile

Ap - 0 to 8 inches: silt loam
Bt - 8 to 22 inches: silt loam
C - 22 to 60 inches: fine sandy loam

Custom Soil Resource Report

Properties and qualities

Slope: 3 to 8 percent

Depth to restrictive feature: 72 to 120 inches to paralithic bedrock

Natural drainage class: Well drained

Runoff class: Medium

Capacity of the most limiting layer to transmit water (Ksat): Moderately high to high
(0.60 to 2.00 in/hr)

Depth to water table: More than 80 inches

Frequency of flooding: None

Frequency of ponding: None

Available water storage in profile: High (about 9.3 inches)

Interpretive groups

Land capability classification (irrigated): None specified

Land capability classification (nonirrigated): 2e

Hydrologic Soil Group: B

Minor Components

Glenville

Percent of map unit: 8 percent

Landform: Hillslopes

Landform position (two-dimensional): Footslope, backslope

Landform position (three-dimensional): Side slope, head slope

Down-slope shape: Linear, concave

Across-slope shape: Concave, linear

MbD—Manor very stony silt loam, 8 to 25 percent slopes

Map Unit Setting

National map unit symbol: 16t0

Elevation: 200 to 2,000 feet

Mean annual precipitation: 35 to 55 inches

Mean annual air temperature: 45 to 61 degrees F

Frost-free period: 110 to 235 days

Farmland classification: Not prime farmland

Map Unit Composition

Manor, very stony, and similar soils: 90 percent

Minor components: 10 percent

Estimates are based on observations, descriptions, and transects of the mapunit.

Description of Manor, Very Stony

Setting

Landform: Hills

Landform position (two-dimensional): Shoulder, backslope

Landform position (three-dimensional): Side slope, nose slope

Down-slope shape: Linear, convex

Across-slope shape: Convex, linear

Custom Soil Resource Report

Parent material: Residuum weathered from mica schist

Typical profile

A - 0 to 10 inches: channery silt loam
B - 10 to 23 inches: channery silt loam
C - 23 to 60 inches: channery loam

Properties and qualities

Slope: 8 to 25 percent
Percent of area covered with surface fragments: 1.6 percent
Depth to restrictive feature: 72 to 120 inches to paralithic bedrock
Natural drainage class: Well drained
Runoff class: High
Capacity of the most limiting layer to transmit water (Ksat): Moderately high to high
(0.60 to 2.00 in/hr)
Depth to water table: More than 80 inches
Frequency of flooding: None
Frequency of ponding: None
Available water storage in profile: Moderate (about 9.0 inches)

Interpretive groups

Land capability classification (irrigated): None specified
Land capability classification (nonirrigated): 6s
Hydrologic Soil Group: B

Minor Components

Glenville

Percent of map unit: 5 percent
Landform: Hillslopes
Landform position (two-dimensional): Footslope, backslope
Landform position (three-dimensional): Side slope, head slope
Down-slope shape: Linear, concave
Across-slope shape: Concave, linear

Chester

Percent of map unit: 3 percent
Landform: Hills
Landform position (two-dimensional): Summit, shoulder
Landform position (three-dimensional): Side slope, nose slope
Down-slope shape: Linear, convex
Across-slope shape: Convex, linear

Glenelg

Percent of map unit: 2 percent
Landform: Hillslopes
Landform position (two-dimensional): Shoulder, backslope
Landform position (three-dimensional): Side slope, nose slope
Down-slope shape: Linear, convex
Across-slope shape: Convex, linear

References

American Association of State Highway and Transportation Officials (AASHTO). 2004. Standard specifications for transportation materials and methods of sampling and testing. 24th edition.

American Society for Testing and Materials (ASTM). 2005. Standard classification of soils for engineering purposes. ASTM Standard D2487-00.

Cowardin, L.M., V. Carter, F.C. Golet, and E.T. LaRoe. 1979. Classification of wetlands and deep-water habitats of the United States. U.S. Fish and Wildlife Service FWS/OBS-79/31.

Federal Register. July 13, 1994. Changes in hydric soils of the United States.

Federal Register. September 18, 2002. Hydric soils of the United States.

Hurt, G.W., and L.M. Vasilas, editors. Version 6.0, 2006. Field indicators of hydric soils in the United States.

National Research Council. 1995. Wetlands: Characteristics and boundaries.

Soil Survey Division Staff. 1993. Soil survey manual. Soil Conservation Service. U.S. Department of Agriculture Handbook 18. http://www.nrcs.usda.gov/wps/portal/nrcs/detail/national/soils/?cid=nrcs142p2_054262

Soil Survey Staff. 1999. Soil taxonomy: A basic system of soil classification for making and interpreting soil surveys. 2nd edition. Natural Resources Conservation Service, U.S. Department of Agriculture Handbook 436. http://www.nrcs.usda.gov/wps/portal/nrcs/detail/national/soils/?cid=nrcs142p2_053577

Soil Survey Staff. 2010. Keys to soil taxonomy. 11th edition. U.S. Department of Agriculture, Natural Resources Conservation Service. http://www.nrcs.usda.gov/wps/portal/nrcs/detail/national/soils/?cid=nrcs142p2_053580

Tiner, R.W., Jr. 1985. Wetlands of Delaware. U.S. Fish and Wildlife Service and Delaware Department of Natural Resources and Environmental Control, Wetlands Section.

United States Army Corps of Engineers, Environmental Laboratory. 1987. Corps of Engineers wetlands delineation manual. Waterways Experiment Station Technical Report Y-87-1.

United States Department of Agriculture, Natural Resources Conservation Service. National forestry manual. http://www.nrcs.usda.gov/wps/portal/nrcs/detail/soils/home/?cid=nrcs142p2_053374

United States Department of Agriculture, Natural Resources Conservation Service. National range and pasture handbook. <http://www.nrcs.usda.gov/wps/portal/nrcs/detail/national/landuse/rangepasture/?cid=stelprdb1043084>

Custom Soil Resource Report

United States Department of Agriculture, Natural Resources Conservation Service. National soil survey handbook, title 430-VI. http://www.nrcs.usda.gov/wps/portal/nrcs/detail/soils/scientists/?cid=nrcs142p2_054242

United States Department of Agriculture, Natural Resources Conservation Service. 2006. Land resource regions and major land resource areas of the United States, the Caribbean, and the Pacific Basin. U.S. Department of Agriculture Handbook 296. http://www.nrcs.usda.gov/wps/portal/nrcs/detail/national/soils/?cid=nrcs142p2_053624

United States Department of Agriculture, Soil Conservation Service. 1961. Land capability classification. U.S. Department of Agriculture Handbook 210. http://www.nrcs.usda.gov/Internet/FSE_DOCUMENTS/nrcs142p2_052290.pdf