

# Erosion and Sedimentation Control Plan

---

Company:

Project:

Location:

Person Responsible (ECP Lead):

Effective 6 June, 2014

Revised September 2017



# TABLE OF CONTENTS

<b>TABLE OF CONTENTS</b>	<b>I</b>
<b>DEFINITIONS</b>	<b>VI</b>
<b>1. INTRODUCTION</b>	<b>1</b>
1.1 Purpose of this Plan	1
1.2 Guidelines and Requirements	2
1.3 Surveys, Permits & Notifications	2
1.4 Inquiries	2
<b>2. SUPERVISION AND INSPECTION</b>	<b>3</b>
2.1 Role & Responsibilities of the Environmental Inspector	3
2.2 Environmental Training for Construction	5
<b>3. CONSTRUCTION TECHNIQUES FOR NATURAL GAS FACILITIES</b>	<b>6</b>
3.1 Typical ROW Requirements	6
3.2 Access Roads & Access Points	6
3.3 Pipe and Contractor Wareyards	8
3.4 Off-ROW Disturbance	8
3.5 Construction Sequence for Pipeline Installation	9
3.5.1 Clearing & Flagging	10
3.5.2 Temporary Sediment Barriers	11
3.5.3 Grading	11
3.5.3.1 Topsoil Segregation	11
3.5.3.2 Tree Stump Removal and Disposal	12
3.5.3.3 Rock Management	13
3.5.4 Temporary Slope Breakers	13
3.5.5 Trenching	14
3.5.5.1 Temporary Trench Plugs	14
3.5.6 Trench & Site Dewatering	15
3.5.7 Pipe Installation	15
3.5.7.1 Stringing and Bending	16
3.5.7.2 Welding	16
3.5.7.3 Lowering-in and Tie-ins	16



3.5.8	<b>Backfilling</b>	16
3.5.8.1	Permanent Trench Breakers	17
3.5.9	<b>Hydrostatic Testing</b>	17
3.5.10	<b>Pipeline Abandonment and Removal</b>	19
3.6	<b>ROW Restoration &amp; Final Cleanup</b>	19
3.6.1	<b>Permanent Erosion Control</b>	20
3.6.1.1	Permanent Slope Breakers	20
3.6.1.2	Erosion Control Fabric / Blankets	21
3.6.2	<b>Revegetation and Seeding</b>	22
3.6.3	<b>Mulch</b>	23
3.6.4	<b>Frozen Conditions &amp; Winter Construction</b>	24
3.6.5	<b>Unauthorized Vehicle Access to ROW</b>	24
3.7	<b>Aboveground Facility Construction</b>	24
4.	<b>SPECIAL CONSTRUCTION METHODS</b>	27
4.1	<b>Agricultural Areas</b>	27
4.1.1	Drain Tiles	27
4.1.2	Irrigation	27
4.1.3	Soil Compaction Mitigation & Restoration	27
4.2	<b>Road Crossings</b>	28
4.3	<b>Residential Areas</b>	28
4.3.1	Stove Pipe Technique	29
4.3.2	Drag Section Technique	29
4.3.3	Residential Area Cleanup and Restoration	29
4.4	<b>Horizontal Directional Drill Method</b>	30
5.	<b>WATERBODY CROSSINGS</b>	32
5.1	<b>General Waterbody Procedures</b>	32
5.1.1	Time Windows for Instream Work	33
5.1.2	Equipment Bridges	33
5.1.3	Clearing and Grading near Waterbodies	34
5.1.4	Temporary Erosion and Sediment Controls at Waterbodies	34
5.2	<b>Types of Waterbody Crossing Methods</b>	35
5.2.1	Flume Crossing	35
5.2.2	Dam-and-Pump Crossing	36
5.2.3	Wet Crossing	37
5.3	<b>FERC Waterbody Classifications</b>	37



5.3.1	Minor Waterbodies	37
5.3.2	Intermediate Waterbodies	38
5.3.3	Major Waterbodies	38
5.4	Restoration	39
6.	<b>WETLAND CROSSINGS</b>	40
6.1	General Wetland Procedures	40
6.2	Clearing and Grading at Wetlands	41
6.3	Temporary Erosion & Sediment Control at Wetlands	42
6.4	Wetland Crossing Procedure	42
6.4.1	Push-pull Technique	43
6.5	Wetland Cleanup and Restoration	43
7.	<b>SPILL PREVENTION &amp; RESPONSE</b>	45
7.1	SPCC / PPC Plan	45
7.2	Spill Prevention Measures	45
7.3	Spill Cleanup & Response	46
8.	<b>POST-CONSTRUCTION ACTIVITIES</b>	47
8.1	Post-Construction Monitoring	47
8.2	Post-Construction Maintenance	48
8.2.1	Uplands	48
8.2.2	Waterbodies and Wetlands	48
8.3	Reporting	49

**APPENDIX A – E&SCP FIGURES**

**APPENDIX B – WATERBODY REFERENCE CITING FERC REQUIREMENTS**

**APPENDIX C – SEED MIX RECOMMENDATIONS**

# LIST OF FIGURES

# APPENDIX A

Figure Number	<u>CATEGORY ABBREVIATION / Figure Name</u>
<u>CONSTRUCTION WORK AREAS (CW)</u>	
CW-1	Typical Trench Detail
CW-2	Right-of-Way Topsoil Segregation Techniques
CW-3	Typical Construction Widths Acquiring New Permanent Right-of-Way
CW-4	Typical Construction Widths Not Acquiring New Permanent Right-of-Way (Single Line System)
CW-5	Typical Construction Widths Not Acquiring New Permanent Right-of-Way (Multiple Line System)
<u>ACCESS ROADS &amp; ROAD CROSSINGS (RD)</u>	
RD-1	Access Road Cross Section
RD-2	Rock Access Pad
RD-3	Typical Temporary Access Road Through Wetlands
RD-4	Typical Paved Road Crossing Control Measures (Open Cut)
RD-5	Typical Paved Road Crossing Control Measures (Bored)
<u>EROSION CONTROLS (EC)</u>	
EC-1	Silt Fence Detail
EC-2	Straw Bale Detail
EC-3	Straw Bale Check Dam in a Drainageway
EC-4	Rock-lined Drainage Swale
EC-5	Storm Drain Inlet Protection
EC-6	Temporary Trench Plug Options
EC-7	Temporary Slope Breaker
EC-8	Permanent Slope Breaker
EC-9	Chevron Slope Breaker
EC-10	Trench Breaker Detail (Sack)
EC-11	Trench Breaker Detail (Foam)
EC-12	Permanent Trench Breaker Options
EC-13	Erosion Control Fabric/Blanket Installation
EC-14	Typical Erosion Control Blankets on Slopes

## LIST OF FIGURES, continued

Figure Number	<u>CATEGORY ABBREVIATION</u> / Figure Name
<u>WATER DISCHARGES (WD)</u>	
WD-1	Filter Bag
WD-2	Discharge Structure for Hydrostatic Test Water
WD-2	Options for Small Water Discharges
WD-3	Discharge of Hydrostatic Test Water to a Surface Water
<u>BRIDGES (BR)</u>	
BR-1	Temporary Equipment Bridge (Equipment Pads with or without Culverts)
BR-2	Temporary Equipment Bridge (Crushed Stone with Culverts)
BR-3	Temporary Equipment Bridge (Flexi-float or Portable Bridge)
<u>WATERBODY &amp; WETLAND CROSSINGS (WC)</u>	
WC-1	Typical Standard Wetland Crossing
WC-2	Typical Wet Waterbody Crossing
WC-3	Typical Flume Waterbody Crossing
WC-4	Typical Dam-and-Pump Waterbody Crossing
WC-5	Typical Erosion Control Blankets on Streambanks
WC-6	Typical Rip-Rap Placement
<u>SPECIAL USE / AGRICULTURAL &amp; RESIDENTIAL AREAS (SU)</u>	
SU-1	Drain Tile Repair Procedure

## DEFINITIONS

**7(c)** – Activities authorized under a project-specific Certificate of Public Convenience and Necessity from the Federal Energy Regulatory Commission (FERC), pursuant to Section 7(c) of the Natural Gas Act, to transport or sell natural gas, as well as construct, acquire, extend, alter or operate specific natural gas facilities that provide natural gas service.

**Abandonment** – Permanent reduction in the availability for service of a FERC jurisdictional facility, including facility modifications which would result in changes to certificated parameters (e.g., permanently operating compressors at lower than certificated horsepower or pipelines at lower than certificated design pressures) as well as changes in operating status (e.g., abandoned-in-place, idled and not maintained, decommissioned or removed facilities). Abandonment of pipe or facilities may be authorized under the blanket certificate or a project-specific Order of Abandonment by FERC, in accordance with Section 7(b) of the Natural Gas Act.

**Agricultural Land** – Actively cultivated and rotated land used for the production of crops including but not limited to corn, grains, orchards, vineyards and hayfields.

**Blanket Certificate Project** – Blanket certificate authorization is obtained from FERC by the Company and allows the Company to construct, modify, acquire, operate, and abandon a limited set of natural gas facilities, and offer a set of services without the need for further activity-specific certificate authorizations. Regulations for FERC’s Blanket Certificate program are provided under Title 18 CFR Part 157, Subpart F. Examples of these projects include, but is not limited to, pipe replacements requiring new permanent right-of-way (ROW) or temporary workspace outside of the original construction footprint, miscellaneous pipe rearrangements, new receipt and delivery points, abandonments, temporary compression facilities, underground storage field remediation and maintenance activities, and underground storage testing and development activities.

**Chief Inspector** – Person, designated by the Company, responsible for the quality assurance of construction activities on a project by managing on-site project inspection staff and ensuring the construction contractor meets the requirements of the Company’s construction specifications, permits, and any plans and drawings related to specific construction activities. All inspectors on the project report to the Chief Inspector and the Chief Inspector reports to the Company’s Construction Superintendent.

**Clearance Package/Permit Book** – The document issued by the Company’s Environmental Construction Permitting (ECP) Department that contains all of the necessary environmental permits, clearances, plans and other requirements specific to a project. The Clearance Package/Permit Book is also included as part of the construction contract.

**Deviation** – A change to the placement of work limits, structures specified in the construction drawings, or changes in the design of control measures as set forth in the E&SCP, with the exception of minor variations from specifications in the typical E&SCP figures (refer to Appendix A) that are required due to site-specific conditions and which are designed to achieve an equivalent or greater degree of environmental protection.

**Environmental Inspector (EI)** – On-site Company representative responsible for inspecting and verifying site compliance with environmental conditions identified in the E&SCP as well as project-specific terms and conditions



contained within the Clearance Package / Permit Book. The environmental inspector will perform the duties that are outlined in Section 2.1 of this plan.

**Ephemeral stream** – Waterbody which flows water only during precipitation events in a typical year and for a short duration after the events. Runoff from rainfall is the primary source of water for stream flow. Ephemeral stream beds are located above the water table year-round. Groundwater is not a source of water for the stream.

**Intermediate waterbody** – Defined by FERC as a waterbody greater than 10 feet wide but less than or equal to 100 feet wide, measured from water's edge to water's edge at the time of construction.

**Intermittent stream** – Waterbody which flows during certain times of the year when groundwater provides water for stream flow. During dry periods, intermittent streams may not have flowing water. Runoff from rainfall is a supplemental source of water for stream flow.

**Line List** – A list prepared by the Company of project-specific instructions for all properties affected by the project, specifying each property owner, the length of crossing, and any special instructions or restrictions for construction crew(s).

**Major waterbody** – Defined by FERC as a waterbody greater than 100 feet wide, measured at the water's edge at the time of construction.

**Minor waterbody** – Defined by FERC as a waterbody less than or equal to 10 feet wide, measured at the water's edge at the time of construction.

**Pasture** – Non-forested land used for grazing of domesticated livestock (horses, cattle, sheep, etc.). Pasture receives periodic renovation and treatments such as tillage, fertilization, mowing, weed control, and may be irrigated. Typical vegetation consists primarily of grasses, herbaceous plants, legumes, and forbs.

**Perennial stream** – Waterbody which flows water year-round during a typical year. The water table is located above the stream bed for most of the year. Groundwater is the primary source of water for stream flow and runoff from rainfall is a supplemental source of water for stream flow.

**Riparian area** – Ecosystems that occupy the transitional zone between terrestrial and aquatic ecosystems. Typical examples of riparian areas include floodplains, streambanks, and lakeshores.

#### **Spill Prevention, Control and Countermeasure Plan /**

**Preparedness, Prevention and Contingency Plan for Construction Projects (SPCC / PPC Plan)** – Company document that contains measures to prevent or reduce the risk of spills or accidental exposure of oil or hazardous materials associated with construction activities, as well as procedures to be employed in the event of a spill, including measures that provide for prompt and effective cleanup of spills, notifications and proper disposal of waste generated during cleanup.

**State-designated waterbody** – Waterbodies specifically identified or recognized by the States or authorized Indian Tribe for water use, value or quality. Designations take into consideration the protection and propagation fish, shellfish and wildlife, as well as use and value for public water supplies, agricultural, industrial, recreational and other purposes, such as navigation. FERC's Procedures contain specific requirements with regards to state-designated fisheries.



**Sensitive resource area** – Areas (defined by FERC) that include wetlands, waterbodies, cultural resource sites, or sensitive species habitats.

**Take up-and-Relay Pipeline Construction** – Also called “lift and relay”, Company construction terminology for the removal of existing pipe and installation of new pipe at the same alignment within the existing permanent easement.

**Wetland** – Areas that are inundated or saturated by surface or groundwater at a frequency or duration sufficient to support and, under normal circumstances, do support a prevalence of vegetation typically adapted for life in saturated soil conditions. Types of wetlands include swamps, marshes, bogs, sloughs, wet meadows, mudflats and natural ponds.

**Waterbody** – Any natural or artificial stream, river, or drainage with perceptible flow at the time of crossing during construction, as well as other permanent waterbodies such as ponds and lakes.

# 1. INTRODUCTION

## 1.1 PURPOSE OF THIS PLAN

This Erosion and Sedimentation Control Plan (E&SCP) has been prepared for use by the Company and its contractors as a guidance manual for minimizing erosion of disturbed soils and transportation of sediments off the construction ROW and into sensitive resource and residential areas during natural gas construction projects. The procedures developed in this plan, which represent the Company's best management practices, are designed to accommodate varying field conditions while achieving compliance with regulatory requirements and protecting environmentally sensitive areas.

This E&SCP is designed to provide guidelines, best management practices and typical techniques for the installation and implementation of soil erosion and sediment control measures while permitting adequate flexibility to use the most appropriate best management practice measures based on site-specific conditions. The intent of the E&SCP is to provide general information on the pipeline construction process and sequence, and to describe specific measures that will be employed during and following construction to minimize impacts to the environment.

Figures provided in Appendix A of this plan illustrate typical and minimum requirements of best management practices for design and utilization of construction workspace areas, access roads and erosion controls, as well as construction methods for special use areas (e.g., agricultural and residential land) and crossing of features during pipeline construction, including wetlands, waterbodies and roads. References to specific figure numbers provided in Appendix A are indicated throughout the E&SCP.

The goal of the E&SCP is to preserve the integrity of environmentally sensitive areas and to maintain existing water quality by:

- Minimizing the extent and duration of disturbance;
- Diverting runoff to stabilized areas;
- Installing temporary and permanent erosion control measures; and
- Establishing an effective inspection and maintenance program.

The E&SCP is intended to be used on Company projects that have been authorized by Federal Energy Regulatory Commission (FERC) pursuant to Section 7(b) and/or 7(c) of the Natural Gas Act to construct, acquire, alter, abandon or operate gas facilities or to provide gas services. This plan is also intended to be used for projects that are conducted under Company's blanket certificate which are regulated under 18 CFR Part 157, Subpart F. All blanket certificate projects that involve ground disturbance or changes to operational air and noise emissions are subject to the FERC's standard environmental conditions, including adherence to FERC's *Upland Erosion Control, Revegetation and Maintenance Plan (Plan)* and *Wetland and Waterbody Construction and Mitigation Procedures (Procedures)*, May 2013 Version.



## 1.2 GUIDELINES AND REQUIREMENTS

The measures described in this E&SCP have been developed based on guidelines from the FERC, United States Army Corps of Engineers (COE), the United States Fish and Wildlife Service, the United States Department of Agriculture, the Natural Resource Conservation Service, and various state agencies as well as from the Company's

significant experience and practical knowledge of pipeline construction and effective environmental protection measures. Lessons and insights gained during pipeline construction projects and comments from agency representatives are also incorporated into this E&SCP.

In accordance with FERC regulations, projects under the jurisdiction of Section 7 or the Company's blanket certificate are required to comply with the FERC's Plan and Procedures unless written approval to deviate from the Plan or Procedures is received from the Director of the Office of Energy Projects and the appropriate state agency. This revised version of the E&SCP is consistent with the requirements of FERC's Plan and Procedures (May 2013 version).

If conflicts or differences occur between project-specific conditions of appropriate federal and state agencies and the best management practices described in this E&SCP, consult with the Company Environmental Construction Permitting Department (ECP) representative or ECP Lead. The more stringent or site-specific requirement is typically applicable unless otherwise approved by ECP. With the exception of minor variations from the typical figures that may be required due to site-specific conditions and are designed to achieve an equivalent or greater degree of environmental protection, any deviations from the construction drawings or changes in the design of control measures as set forth in this E&SCP must be approved by the Company's ECP Lead and the appropriate permitting agency prior to implementation. Measures and practices identified within this plan are to be implemented during construction unless otherwise specified by project-specific permit conditions.

## 1.3 SURVEYS, PERMITS & NOTIFICATIONS

The Company shall perform the required environmental field surveys and acquire the necessary environmental permits, clearances and authorizations prior to start of construction of the project. The Company shall notify the appropriate federal, state, and local agencies prior to, during, and/or subsequent to the construction of the project, as identified in the Clearance Package/Permit Book.

## 1.4 INQUIRIES

Inquiries regarding this E&SCP should be addressed to the ECP Department at the address shown on the front cover. For field conditions requiring an immediate response, contact the designated person responsible at the address shown on the front cover.

## 2. SUPERVISION AND INSPECTION

To effectively mitigate project-related impacts, the E&SCP must be properly implemented in the field. Quick and appropriate decisions in the field regarding critical issues such as stream and wetland crossings, placement of erosion controls, trench dewatering, spoil containment, and other construction-related items are essential.

To ensure that the E&SCP is properly implemented, at least one Environmental Inspector (EI) will be designated by the Company for each construction spread during active construction or restoration activities. The EI is responsible for verifying environmental compliance on the construction spread, and performing the duties that are outlined in Section 2.1 below.

### 2.1 ROLE & RESPONSIBILITIES OF THE ENVIRONMENTAL INSPECTOR

EIs will have the authority to stop activities that violate the environmental conditions of the FERC's Orders (if applicable), stipulations of other environmental permits or approvals, or landowner easement agreements, as well as order appropriate corrective action.

The EI will have peer status with all other activity inspectors and will report directly to the Chief Inspector who has overall authority on the construction spread or project.

The number and experience of EIs assigned to each construction spread shall be appropriate for the length of the construction spread and the number/significance of resources affected. On 7(c) and other large construction projects, the person designated as the EI will typically be a dedicated role for each construction spread. On blanket certificate projects and any other small construction activities carried out under this E&SCP, the EI role may be carried out by the Chief Inspector or another designated and properly trained Company Inspector on site, at the discretion of the Company. In such instances, the Company may employ additional periodic oversight of the EI by an environmental specialist.

At a minimum, the EI shall be responsible for:

1. Inspecting construction activities for compliance with the requirements of this E&SCP, the construction drawings, the environmental conditions of the FERC's Orders (if applicable), proposed mitigation measures, other federal or state and local (if applicable) environmental permits and approvals, and environmental requirements in landowner easement agreements;
2. Identifying, documenting, and overseeing corrective actions, as necessary to bring an activity back into compliance;
3. Verifying that the limits of authorized construction work areas and locations of access roads are visibly marked before clearing, and maintained throughout construction;
4. Verifying the location of signs and highly visible flagging marking the boundaries of sensitive resource areas, including waterbodies and wetlands, or areas with special requirements along the construction work area;
5. Identifying erosion/sediment control and soil stabilization needs in all areas;

6. Ensuring that the design of slope breakers will not cause erosion or direct water into sensitive resource areas, including cultural resource sites, wetlands, waterbodies and sensitive species habitats;
7. Verifying that dewatering activities are properly monitored and do not result in the deposition of sand, silt, and/or sediment into sensitive resource areas, including wetlands, waterbodies, cultural resource sites, and sensitive species habitat; stopping dewatering activities if such deposition is occurring and ensuring the design of the discharge is changed to prevent reoccurrence; and verifying that dewatering structures are removed after completion of dewatering activities;
8. Ensuring that subsoil and topsoil are tested in agricultural and residential areas to measure compaction and determine the need for corrective action;
9. Advising the Chief Inspector when environmental conditions (such as wet weather, severe storm events or frozen soils) make it advisable to restrict or delay construction activities to avoid topsoil mixing excessive compaction;
10. Ensuring restoration of contours and topsoil;
11. Verifying that the soils imported for agricultural or residential use have been certified as free of noxious weeds and soil pests, unless otherwise approved by the landowner, and is considered clean and free of hazardous materials;
12. Ensuring that the appropriate erosion/sediment control and stabilization needs are implemented in all areas, including ensuring that erosion and sediment controls are properly installed and maintained daily to prevent sediment flow into sensitive resource areas (e.g., wetlands, waterbodies, cultural resource sites, and sensitive species habitats) and onto roads, and determining the need for additional erosion control devices;
13. Inspecting and ensuring the maintenance of temporary erosion and sediment control measures at least:
  - a. On a daily basis in areas of active construction or equipment operation;
  - b. On a weekly basis in areas with no construction or equipment operation; and
  - c. Within 24 hours of each 0.5 inch of rainfall.
14. Ensuring the repair of all ineffective temporary erosion and sediment control measures within 24 hours of identification, or as soon as conditions allow if compliance with this time frame would result in greater environmental impacts;
15. Identifying areas that should be given special attention to ensure stabilization and restoration after the construction phase;
16. Ensuring proper seed mixes, rates and restoration methods are used, and obtaining documentation;

17. Ensuring that the Contractor implements and complies with the Company's *Spill Prevention, Control and Countermeasure Plan & Preparedness, Prevention and Contingency Plan for Construction Projects* (SPCC/PPC Plan), the Company's *Waste Management Plan*, and other Company environmental documents and standard operating procedures;
18. Verifying that locations for any disposal of excess construction materials for beneficial reuse comply with this E&SCP and any applicable permits / clearances; and,
19. Keeping records of compliance with the environmental conditions of the FERC's Orders and the mitigation measures proposed by the Company in the application submitted to the FERC (if applicable), and other federal or state environmental permits during active construction and restoration. Records should include photo documentation.

## 2.2 ENVIRONMENTAL TRAINING FOR CONSTRUCTION

Environmental training will be given to both the Company personnel and contractor personnel whose activities have the potential to impact the environment during pipeline construction. All construction personnel from the Chief Inspector, EI, craft inspectors, contractor job superintendent to loggers, welders, equipment operators, and laborers will be given some form of environmental training. The level of training will be commensurate with the type of duties of the personnel. At the discretion of the Company, environmental training for personnel may also be required on projects where it is not required by FERC.

Training will be given prior to the start of construction and throughout the construction process, as needed, and will cover the following issues:

- Specifics of this E&SCP and other Company plans;
- Job or activity specific permit requirements;
- Company policies and commitments;
- Cultural resource procedures and restrictions;
- Threatened and endangered species procedures and restrictions; and
- Any other pertinent information related to the job.

In addition to the EI, all other construction personnel are expected to play an important role in maintaining strict compliance with all permit conditions, and to promptly report any conditions that are perceived as having the potential to threaten environmental protection to the appropriate inspector during construction.

## 3. CONSTRUCTION TECHNIQUES FOR NATURAL GAS FACILITIES

### 3.1 TYPICAL ROW REQUIREMENTS

Pipeline construction workspace requirements are a function of pipe diameter, equipment size, topography, geological rock formations, location of construction such as at road crossings or river crossings, pipeline crossovers, methods of construction such as boring or open-cut construction, or existing soil conditions encountered during construction. As the diameter of the pipeline being installed increases, so does the depth of trench, excavated spoil material, equipment size, and ultimately the amount of construction work space that will be required to construct a project. See Figure CW-1 for a detail of a typical trench and Figures CW-3, CW-4 and CW-5 for typical construction ROW widths. All workspace locations for a given project will be shown on the construction drawings.

Additional construction ROW may be required at specific locations including, but not limited to, steep side or vertical slopes, road crossings, pipeline crossovers, areas requiring supplemental topsoil segregation, and staging areas associated with wetland and waterbody crossings. In particular, as shown on the construction drawings, the construction ROW width may be expanded up to 25 feet for the following situations / areas without approval from the FERC, however, prior approval is required from the EI or ECP:

- Accommodate full construction ROW topsoil segregation;
- Ensure safe construction where topographic conditions, such as side-slopes, or soil limitations exist; and
- Facilitate truck turn-arounds where no reasonable alternative access exists in limited, upland, non-riparian or non-forested areas.

All construction activities, including staging areas and additional spoil storage areas, are restricted to the construction ROW limits identified on the construction drawings, except for specific activities in limited, non-wetland and non-riparian areas that are allowed by the FERC Plan and Procedures (i.e. slope breakers, energy-dissipating devices, dewatering structures, and drain tile system repairs). Use of these limited areas is subject to landowner or land management agency approval and compliance with all applicable survey, permit, and reporting requirements; therefore, prior Company approval is required to use these areas. In some cases, federal, state and local permits and authorizations may require additional approvals.

Minor field realignments and workspace shifts per landowner needs and requirements are only allowed if construction activities remain within the environmental field survey area, comply with project-specific environmental permits and landowner easements, and do not affect new landowners or sensitive resource areas.

### 3.2 ACCESS ROADS & ACCESS POINTS

To the extent practical, all access to the construction ROW will be limited to existing roads and will be minimized in wetlands. However, additional access roads to the construction ROW may be required at various points along the project where other road crossings (paved or gravel state/local roads) do not exist. Examples of types of access used include pipeline ROWs, abandoned town roads, railroad ROWs, power

line service roads, logging roads and farm roads. Improvements to access roads (i.e., grading, placing gravel, replacing/installing culverts, and trimming overhanging vegetation) may be required due to the size and nature of the equipment that would utilize the road (Figure RD-1). The following conditions apply to the use of all access roads:

1. During construction and restoration activities, access to the ROW is limited to the use of new or existing access roads identified on the construction drawings.
2. The only access roads that can be used in wetlands, other than the construction ROW, are those existing roads requiring no modification or improvements, other than routine repair, and posing no impact on the wetland.
3. The construction ROW may be used for access across wetlands when the wetland soil is firm enough to avoid rutting or the construction ROW has been appropriately stabilized to avoid rutting (e.g., with timber riprap, prefabricated equipment mats, or terra mats). However, access is not allowed through wetlands that are specifically being avoided by HDD or would not otherwise be impacted by the project.
4. In wetlands that cannot be appropriately stabilized, all construction equipment other than that needed to install the wetland crossing shall use access roads located in upland areas. Where access roads in upland areas do not provide reasonable access, limit all other construction equipment to one pass through the wetland using the construction ROW.
5. Blanket certificate projects may not have construction drawings available in which case access to the ROW will be identified in the Clearance Package / Permit Book.
6. Maintain safe and accessible conditions at all road crossings and access points during construction and restoration. Access road maintenance through the construction sequence may include grading and the addition of gravel or stone when necessary.
7. Maintain access roads in a stable manner to prevent off-ROW impacts, including impacts to adjacent and/or nearby sensitive resource areas, and implement all appropriate erosion and sediment control measures for construction/improvement of access roads.
8. Minimize the use of tracked equipment on public roadways.
9. Remove any soil or gravel spilled or tracked onto roadways daily or more frequent as necessary to maintain safe road conditions.
10. Repair any damages to roadway surfaces, shoulders, and bar ditches.
11. If crushed stone/rock access pads are used in residential or agricultural areas, stone shall be placed on synthetic, nonwoven geotextile fabric to facilitate removal after construction (Figure RD-2).
12. All access roads across a waterbody must use an equipment bridge in accordance with Section 5.1.2.

13. For access through a saturated wetland, use timber mats or an equivalent, unless otherwise authorized by agency permits (Figure RD-3).
14. Limit construction equipment operating in wetland areas to that needed to clear the ROW, dig the trench, fabricate and install the pipeline, backfill the trench, and restore the construction ROW. All other construction equipment shall use access roads located in upland areas to the maximum extent practical.

### **3.3 PIPE AND CONTRACTOR WAREYARDS**

Pipe and contractor wareyards are required for storing and staging equipment, pipe, fuel, oil, pipe fabrication, and other construction-related materials and preparations. The Contractor shall perform the following measures at pipe and contractor wareyards:

1. Strip and segregate topsoil in agricultural lands;
2. Install erosion and sediment control structures as directed by the EI or identified on the construction drawings, and as outlined in this E&SCP and the SPCC/PPC Plan. Maintain controls throughout construction and restoration activities;
3. Implement and comply with the SPCC/PPC Plan and the Waste Management Plan, including the completion of any required site-specific forms and attachments; and,
4. Restore and revegetate all disturbed areas in accordance with the measures outlined in this E&SCP, landowner agreements and/or as directed by the EI. At a minimum, the area must be returned to preconstruction contours and stabilized prior to contractor demobilization.

### **3.4 OFF-ROW DISTURBANCE**

All construction activities are restricted to the construction ROW limits identified on the construction drawings, except for specific activities in limited, non-wetland and non-riparian areas that are allowed by the FERC Plan and Procedures. Activities allowed to occur off-ROW are limited to the installation of slope breakers, energy-dissipating devices and dewatering structures, as well as repairs to drain tile. Minor field realignment and workspace shifts per landowner needs and requirements are only allowed if construction activities remain within the environmental field survey area, maintain compliance with project-specific environmental permits and landowner easements, do not affect new landowners or environmental resources, and do not require the operation of heavy equipment off ROW. In the event that inadvertent off-ROW disturbance occurs, the following measures will be implemented:

1. The EI will immediately report the occurrence to the Chief Inspector and ROW Agent;
2. The conditions that caused the disturbance will be evaluated by the Chief Inspector and the EI, and they will determine whether work at the location can proceed under those conditions; and
3. If determined to be necessary by the Chief Inspector and EI, one or more of the following corrective actions will be taken: immediate restoration of the preconstruction contours, seeding and mulching of the disturbed area, and/or installation of erosion or sediment control devices, conduct additional tailgate or employee/contractor training, and investigation of the issue to develop lessons learned for future issue prevention.

4. The Company's ECP Department will be notified.

### 3.5 CONSTRUCTION SEQUENCE FOR PIPELINE INSTALLATION

Natural gas pipelines are installed using conventional overland buried pipeline construction techniques. These activities are necessary for the installation of a stable, safe, and reliable transmission facility consistent with U.S. Department of Transportation (U.S.DOT) requirements and regulations. This section provides an overview of the equipment and operations necessary for the installation of a natural gas pipeline, describes potential impacts that may occur from each operation, and identifies the measures that will be implemented to control these potential impacts. This section also discusses in detail the erosion and sediment control techniques that typically apply to each construction activity including clearing, grading, trenching, lowering-in of pipe, backfilling, and hydrostatic testing. Pipe abandonment in-place or removal, which may be associated with a pipeline replacement activity or occur as an independent activity on an existing pipeline, are also covered at the end of this section. ROW restoration is the final step in the typical construction sequence and will be addressed in Section 3.6.

Installation of the pipeline typically proceeds in a linear manner from one end of the construction spread to the other in an assembly line or "mainline" fashion. However, different stages may be running in parallel on different physical segments of the project. In some cases, this means that full completion of one of the construction sequence stages described below may not occur before the next construction sequence stage is initiated. Construction sequencing should be planned to limit the amount and duration of open trench sections, as necessary, to prevent excessive erosion or sediment flow into sensitive environmental resource areas. This is due to the Company's effort to adhere to strict construction schedules in order to minimize safety concerns, landowner effects, and environmental disturbance. The spacing between the individual crews responsible for each interdependent activity is based on anticipated rate of linear progress. The activities listed below are typically performed in the following sequence:

- Surveying and flagging the ROW;
- Clearing the ROW;
- Installing temporary sediment barriers;
- Grading the ROW;
- Installing temporary slope breakers;
- Trenching/excavating the trench;
- Pipe stringing and bending;
- Welding and weld inspection;
- Lowering the pipe into the trench;
- Backfilling the trench;
- Hydrostatic testing of pipe; and
- ROW restoration and clean-up.

Obstacles to the mainline technique are often encountered and are not considered to be out of the ordinary. These obstacles, which include side hill crossings, rock, wetlands, streams, roads and residential areas, do not normally interrupt the assembly line flow.

### 3.5.1 Clearing & Flagging

Clearing operations include the removal of vegetation within the construction ROW. Various clearing methods are employed depending on tree size, contour of the land, and the ability of the ground to support clearing equipment. Vegetative clearing can be accomplished either by hand or by cutting equipment. The following procedures will be standard practice during clearing:

1. Prior to beginning the removal of vegetation,
  - a. The limits of clearing will be established and visibly marked before clearing;
  - b. Signs and highly visible flagging will also be used to mark the boundaries of sensitive resource areas, including waterbodies and wetlands, and/or areas with special requirements along the construction work area, in accordance with the construction drawings;
  - c. Flagging or marking shall be maintained throughout construction;
  - d. Trees to be protected per landowner requests or as otherwise directed will be clearly marked;
2. All construction activities and ground disturbance will be confined to within the construction ROW shown on the construction drawings (with the limited exception of compliance activities described above in Section 3.4);
3. All brush and trees will be felled into the construction ROW to minimize damage to trees and structures adjacent to the ROW. Trees that inadvertently fall beyond the edge of the ROW will be immediately moved onto the ROW and disturbed areas will be immediately stabilized, per landowner approval;
4. Trees will be chipped and removed or cut into lengths identified by the landowner and then stacked at the edge of the ROW or removed. Trees may be burned depending on local and state restrictions, applicable permits, construction Line List stipulations, and landowner agreements;
5. Brush and limbs may be disposed of in one or more of the following ways depending on local restrictions, applicable permits, construction Line List stipulations, and landowner agreements:
  - a. Stockpiled along the edge of the ROW;
  - b. Burned;
  - c. Chipped, spread across the ROW in upland areas, and plowed in at the discretion of the Chief Inspector or EI (excess material must be removed);
  - d. Used as part of erosion control mix material; or
  - e. Hauled off site to a Company-approved location.
6. Existing surface drainage patterns shall not be altered by the placement of timber or brush piles at the edge of the construction ROW.

### 3.5.2 Temporary Sediment Barriers

Sediment barriers, which are temporary sediment controls intended to minimize the flow and deposition of sediment beyond approved workspaces or into sensitive resource areas, shall be installed following vegetative clearing operations. They may be constructed of materials such as silt fence, staked straw bales, compacted earth (e.g., drivable berms across travel lanes), sand bags, or other appropriate materials (Figures EC-1, EC-2, EC-3 and EC-5). Where allowed by regulatory agencies, hay bales may be used in lieu of straw bales with the following restrictions: hay bales shall not be used for mulching and the Contractor is responsible for their removal and disposal.

1. Install temporary sediment barriers at the base of slopes greater than 5% where the base of the slope is less than 50 feet from a road crossing, waterbody and/or wetland in accordance with Sections 5.1.4 and 6.3 respectively.
2. Do not stake or trench in place straw bales used on equipment bridges or on mats across the travel lane.
3. Inspect temporary sediment barriers daily in areas of active construction to ensure proper functioning and maintenance. In other areas with no construction or equipment operation, sediment barriers will be inspected and maintained on a weekly basis throughout construction, and within 24 hours of each 0.5 inch of rainfall. Conduct an inspection within 24 hours once a storm event has produced 0.5 inch of rainfall, even if the storm event is still continuing.
4. Maintain all temporary sediment barriers in place until permanent revegetation measures are successful or the upland areas adjacent to wetlands, waterbodies, or roads are stabilized.
5. Remove temporary sediment barriers from an area when replaced by permanent erosion or sediment control measures or when the area has been successfully restored as specified in Section 8.1.

### 3.5.3 Grading

The construction ROW will be graded as needed to provide a level workspace for safe operation of heavy equipment used in pipeline construction. The following procedures will be standard practice during grading:

#### 3.5.3.1 Topsoil Segregation

During construction, topsoil and subsoil will be disturbed by grading of the right-of-way, trench excavation, and by heavy equipment moving along the right-of-way. Implementation of proper topsoil segregation is intended to mitigate these construction impacts and promote or facilitate post-construction revegetation success.

Topsoil segregation methods will be used in all residential areas (except where the topsoil is being replaced), wetlands (except areas where standing water is present or soils are saturated), cultivated or rotated croplands, managed pastures, hayfields, and other areas at the landowner's or land managing agency's request. Either the "ditch plus spoil side" or the "full right-of-way" segregation method will be used, as illustrated in Figure CW-2.

- a. Prevent the mixing of topsoil with subsoil by stripping topsoil from either the full work area or from the trench and subsoil storage area ("ditch plus spoil side" method) as stipulated in the Construction Contract or Line List.
- b. Segregate at least 12 inches of topsoil in deep soils with more than 12 inches of topsoil. In soils with less than 12 inches of topsoil, make every effort to segregate the entire topsoil layer.
- c. Within wetlands, segregate the top 12 inches of topsoil within the trenchline, except in areas where standing water is present or soils are saturated.
- d. In residential areas, importation of topsoil (i.e. topsoil replacement) is an acceptable alternative to topsoil segregation, if approved by the landowner and Chief Inspector.
- e. Maintain separation of salvaged topsoil and subsoil throughout all construction activities.
- f. Leave gaps in the topsoil piles and spoil piles for the installation of temporary slope breakers to allow water to be diverted off the construction ROW.
- g. Never use topsoil for padding the pipe, constructing temporary slope breakers, trench breakers or trench plugs, improving or maintaining roads, or as a fill material.
- h. Stabilize topsoil piles and minimize loss due to wind and water erosion with use of sediment barriers, mulch, temporary seeding, tackifiers, or functional equivalents, where necessary.

#### 3.5.3.2 Tree Stump Removal and Disposal

- a. Remove tree stumps in upland areas along the entire width of the permanent ROW to allow adequate clearance for the safe operation of vehicles and equipment. Stumps within the temporary ROW will be removed or ground below the surface in accordance with Company construction specifications to allow the safe passage of equipment, as determined by the Chief Inspector or EI.
- b. In wetlands, limit pulling of tree stumps and grading activities to directly over the trenchline.
- c. Dispose of stumps by one of the following methods with the approval of the Chief Inspector and the landowner and in accordance with regulatory requirements:
  - Buried at a Company-approved off-site location (except in wetlands and agricultural areas);
  - Burned on construction ROW;
  - Chipped, spread across the construction ROW in upland areas, and plowed in;
  - Used as erosion control mix material;

- Ground to grade in wetlands, excess chips will be removed for proper disposal; or
  - Hauled off-site.
- d. Grading operations and tree stump removal in wetland areas will be conducted in accordance with Section 6.2.

### 3.5.3.3 Rock Management

Rock, including blast rock, will be used, removed or disposed of in one of the following ways:

- a. Rock excavated from the trench may be used to backfill the trench only to the top of the existing bedrock profile. (Rock that is not returned to the trench shall be considered construction material or waste, unless approved for use as mulch or for some other use on the construction work areas by the land owner or land managing agency.);
- b. Windrowed per written landowner agreement with the Company;
- c. Removed and disposed of at a Company-approved landfill; or
- d. Used as riprap for streambank stabilization as allowed by applicable regulatory agency(ies) and provided the rock is uncontaminated and free of soil and other debris (Figure WC-6).

### 3.5.4 Temporary Slope Breakers

Temporary slope breakers, also called interceptor dikes, are temporary erosion control measures intended to reduce runoff velocity and divert water off the construction ROW. Temporary slope breakers may be constructed of materials such as compacted soil, silt fence, staked straw bales, or sand bags. Segregated topsoil may not be used for constructing temporary slope breakers. If permitted by regulatory agency(ies), hay bales may be used in lieu of straw bales except for mulching. If hay bales are used, the Contractor is responsible for their removal and Company-approved disposal.

1. Install temporary slope breakers on all disturbed areas as necessary following grading operations (Figure EC-7) to avoid excessive erosion. Unless otherwise specified by permit conditions, temporary slope breakers must be installed on slopes greater than 5% at the recommended spacing interval indicated below (Closer spacing should be used if necessary):

<b><u>Slope (%)</u></b>	<b><u>Spacing (feet)</u></b>
< 5	No structure
5 – 15	300
> 15 – 30	200
> 30	100

2. Direct the outfall of each slope breaker to a stable, well vegetated area or construct an energy-dissipating device (silt fence, staked straw bales, erosion control fabric) at the end of the slope breaker.

3. Position the outfall of each temporary slope breaker to prevent sediment discharge into wetlands, waterbodies, or other sensitive resource areas.
4. Install temporary slope breakers across the entire construction ROW along slopes greater than 5 % where the base of the slope is less than 50 feet from waterbody, wetland, and road crossings.
5. Inspect temporary slope breakers daily in areas of active construction to insure proper functioning and maintenance. In other areas, the slope breakers will be inspected and maintained on a weekly basis throughout construction, and within 24 hours of each 0.5 inch of rainfall. Repairs should be made within 24 hours of identification, if possible.

Drivable berms, which are smaller versions of slope breakers constructed of compacted soil or sand bags, may be used in place of staked straw bales at the entrances and exits of travel lanes at road crossings, waterbodies, and wetlands. They are installed across the width of the travel lane at the start of the equipment crossing and made low enough to allow equipment and other vehicles to pass. Yet, they should function to reduce and divert water runoff from sensitive resource areas.

### 3.5.5 Trenching

The trench centerline will be staked after the construction ROW has been prepared. In general, a trench will be excavated to a depth that will permit burial of the pipe with a minimum of 3 feet of cover (Figure CW-1). Overland trenching may be accomplished using a conventional backhoe or a rotary wheel-ditching machine. In shale or rocky areas where the use of the conventional excavation equipment is limited, a tractor-drawn ripper or rock hammer may be employed to break and loosen hard substratum material. In areas where rock cannot be ripped or hammered, drilling and blasting may be required. A backhoe may then be used to remove rock and soil from the ditch.

The following procedures will be standard practice during ditching:

- Flag drainage tiles damaged during ditching activities for repair;
- Place spoil in additional extra work areas or at least 10 feet away from the waterbody's edge in the construction ROW. Spoil will be contained with erosion and sediment control devices to prevent spoil materials or sediment-laden water from transferring into waterbodies and wetlands or off of the ROW; and,
- If temporary erosion or sediment controls are damaged or removed during trenching, they shall be repaired and/or replaced before the end of the work day.

#### 3.5.5.1 Temporary Trench Plugs

Temporary trench plugs are barriers within the ditch that are intended to segment the continuous open trench prior to backfill. They typically consist of unexcavated portions of the ditch (hard plug), compacted subsoil or sandbags (soft plug) placed across the ditch, or some functional equivalent. Along steep slopes, they serve to reduce erosion and sedimentation in the trench and minimize dewatering problems at the base of slopes where sensitive environments such as waterbodies and wetlands are frequently located. In addition, they provide access across the trench for wildlife and livestock.

- a. Do not use topsoil for constructing trench plugs.
- b. Coordinate with the landowner to identify optimal locations for the placement of temporary hard plugs designed to provide access for livestock.
- c. Temporary trench plugs may be used in conjunction with slope breakers to prevent water in the trench from overflowing into sensitive resource areas (Figure EC-6). Attempt to divert trench overflow to a well-vegetated off-ROW location or construct an energy-dissipating device.
- d. Position temporary trench plugs, as necessary, to reduce trenchline erosion and minimize the volume and velocity of trench water flow at the base of slopes.

### 3.5.6 Trench & Site Dewatering

Dewatering may be periodically conducted to remove accumulated groundwater or precipitation from the construction ROW, including from within the trenchline. The need for erosion controls as well as the type of control used will vary depending on the type and amount of sediment within the water, and volume and rate of discharge.

1. Conduct dewatering (on or off the construction ROW) in such a manner that does not cause erosion and does not result in silt-laden water flowing into any waterbody or wetland.
2. Elevate and screen the intake of each hose used to withdraw the water from the trench to minimize pumping of deposited sediments.
3. Water may be discharged into areas where adequate vegetation is present adjacent to the construction ROW to function as a filter medium.
4. Where vegetation is absent or in the vicinity of waterbody / wetland areas, water will be pumped into a discharge structure that accommodates the anticipated discharge volumes as well as type and amount of sediment within the water being discharged, including
  - a. a filter bag, as illustrated in Figure WD-1, or
  - b. a structure composed of sediment barriers (Options for these types of controls are illustrated in Figure WD-2 and WD-3.).

A structure that is more typically used for discharges of hydrostatic test water, as illustrated in Figure WD-2, may be necessary for large volumes of water.

5. When using filter bags, secure the discharge hose to the bag with a clamp.
6. Remove dewatering structures as soon as practicable after the completion of dewatering activities.

### 3.5.7 Pipe Installation

During all phases of the pipe installation process, ensure that all roadway crossings and access points are safe and accessible conditions. Repair damaged temporary erosion controls by the end of the work day. If portions of slope breakers are removed from the travel lane to facilitate safe work conditions, they shall be restored prior to the end of the work day.

#### 3.5.7.1 Stringing and Bending

Following trench excavation, pipe sections will be delivered to the construction site by truck or tracked vehicle, and strung out along the trench. Individual pipe sections will be placed on temporary supports or wooden skids and staggered to allow room for work on the exposed ends. Certain pipe sections will be bent, as necessary, to conform to changes in slope and direction of the trench.

All rope bands should be collected and disposed of properly.

#### 3.5.7.2 Welding

Once the bending operation is complete, the pipe sections will be welded together on supports using approved welding procedures that comply with Company welding specifications. After welding, the welds will be inspected radiographically or ultrasonically to ensure their structural integrity.

#### 3.5.7.3 Lowering-in and Tie-ins

Lowering-in consists of placing the completed pipeline sections into the trench typically using two or more sideboom tractors acting in unison and spaced so as not to buckle or otherwise damage the pipe. The pipeline will be lifted from the supports, swung out over the trench, and lowered directly into the trench. The equipment uses a "leap frogging" technique requiring sufficient area to safely move around other tractors within the construction ROW to gain an advanced position on the pipe. The unwelded ends of the completed pipeline segments (typically present at road crossings, stream crossings, etc.) are then welded together or "tied-in" by specialized tie-in crews.

### 3.5.8 Backfilling

Backfilling consists of covering the pipe with the earth removed from the trench or with other fill material hauled to the site when the existing trench spoil is not adequate for backfill. Backfilling will follow lowering-in of the pipeline as close as is practical.

In areas where the trench bottom is irregularly shaped due to consolidated rock or where the excavated spoil materials are unacceptable for backfilling around the pipe, padding material may be required to prevent damage to the pipe. This padding material will generally consist of sand or screened spoil materials from trench excavation.

1. Under no circumstances shall topsoil be used as padding material.
2. Excess rock, including blast rock, may be used to backfill the trench only to the top of the existing bedrock profile in accordance with Company specifications. Rock that is not used to backfill the trench will be managed as described in Section 3.5.3.3.
3. Any excess material will be spread within the ROW in upland areas and land contours will be roughed-in to match adjacent topography.

4. The trench may be backfilled with a crown over the pipe to compensate for compaction and settling. Openings will be left in the completed trench crown to restore pre-construction drainage patterns. Crowning shall not be used in wetland areas.

#### 3.5.8.1 Permanent Trench Breakers

Permanent trench breakers are intended to slow subsurface water flow and erosion along the trench and around the pipe in sloping terrain. An engineer or similarly qualified professional shall determine the need for and spacing of permanent trench breakers. However, trench breakers will not be installed within a wetland.

Permanent trench breakers will be constructed with sand bags, polyurethane foam, or an equivalent as identified in the permit requirements (Figure EC-10 and EC-11). Topsoil shall not be used to construct trench breakers. Sakrete may be used at the discretion of the Chief Inspector on severe slopes greater than 30 percent.

Permanent trench breakers, which are used in conjunction with slope breakers, shall be installed at the locations shown on the construction drawings, at the same spacing interval as and upslope of permanent slope breakers, or as otherwise determined by an engineer or similarly qualified professional, such as the EI (Figure EC-12). At a minimum, install trench breakers:

- a. At the base of slopes greater than 5% where the base of the slope is less than 50 feet from a waterbody or wetland;
- b. Where needed to avoid draining of a resource, including at wetland boundaries where the pipeline trench may drain a wetland, and/or seal the trench bottom as necessary to maintain the original wetland hydrology; and,
- c. In agricultural fields and residential areas where slope breakers are not typically required, install trench breakers at the same spacing as if permanent slope breakers were required.

#### 3.5.9 Hydrostatic Testing

Once the pipeline is completed and before it is placed into service, it will be hydrostatically tested for structural integrity. Hydrostatic testing involves filling the pipeline with clean water and maintaining a test pressure in excess of normal operating pressures for a specified period of time (typically 8 hours). The testing procedure involves filling the pipeline with water, performing the pressure test, and discharging the test water.

The following general hydrostatic testing procedures shall be adhered to for all projects. Environmental conditions for hydrostatic testing activities are also addressed in the project-specific Hydrostatic Test Clearance Package that is issued by ECP if permits are required for water appropriation and/or discharge. During planning and permitting of test events:

1. Identify the location of all waterbodies proposed for use as a hydrostatic test water source or discharge location. Use only the water sources identified in the Clearance Package/Permit Book.

- a. Do not use water from or discharge into state-designated exceptional value waters, waterbodies that provide habitat for federally listed threatened or endangered species, or waterbodies designated as public water supplies, unless appropriate federal, state, and/or local permitting agencies grant written permission.
2. Locate hydrostatic test manifolds outside wetlands and riparian areas to the maximum extent practicable.
3. Attempt to locate discharge sites in a well-vegetated and stabilized area, if practical, at least 50-feet from adjacent waterbody/wetland areas.
4. Apply for and obtain state-issued water withdrawal permits and National Pollutant Discharge Elimination System (NPDES) or state-issued discharge permits, as required.

During preparation for testing, including appropriation of source water and preparing discharge/outfall site:

1. At least 48 hours before testing activities, the EI shall notify appropriate state agencies (as identified in the relevant permit for hydrostatic test discharges) of the intent to use specific test water sources (unless waived in writing).
2. If pumps used for hydrostatic testing are within 100 feet of any waterbody or wetland, the use of secondary containment, operation and refueling of those pumps will be addressed and conducted in accordance with the SPCC/PPC Plan.
3. Screen the intake hose to minimize the potential for entrainment of fish and other aquatic life.
4. Maintain adequate flow rates to protect aquatic life, provide for all waterbody uses, and provide for downstream withdrawals of water by existing users.
5. Install all discharge structures in a well-vegetated and stabilized area, if practical, and attempt to maintain at least a 50-foot vegetated buffer from adjacent waterbody/wetland areas. If an adequate buffer is not available, sediment barriers or similar sediment control measure must be installed.

During the discharge of hydrostatic test water on-site:

1. Discharge water only at the locations shown on the construction drawings or locations identified in the Clearance Package/Permit Book or ECP's Hydrostatic Test Clearance Package.
2. Regulate rate of discharge water and use energy dissipation device(s) and sediment barriers, as necessary, to prevent erosion, streambed scour to aquatic resources, sedimentation, flooding or excessive stream flow (Figures WD-2 and WD-3).
3. Use absorbent booms as necessary during discharge from existing pipe or as stipulated by the applicable NPDES permit.
4. The test water may be discharged through an appropriate filtration system including holding tanks or frac tanks and/or carbon filters if needed to meet effluent limitations or conditions stipulated in the NPDES permit.

5. Do not discharge into state-designated exceptional value waters, waterbodies which provide habitat for federally listed threatened or endangered species, or waterbodies designated as public water supplies, unless appropriate federal, state, and local permitting agencies grant written permission.
6. The EI or appropriate designee shall sample and test the source water and discharge water in accordance with the permit requirements.

### **3.5.10 Pipeline Abandonment and Removal**

Pipeline abandonment and removal activities may occur when gas service is no longer needed, such as the abandonment of a lateral to a customer receipt or delivery point. Removal or in-place abandonment of pipe can also be conducted as part of an expansion or maintenance project, such as the lift-and-relay of existing pipe, the replacement or relocation of an existing pipeline due to road or highway modifications, or activities required to maintain compliance with U.S.DOT requirements.

Abandonment approval from FERC, such as project-specific Section 7(b) Order or blanket certificate authorization, is required prior to abandoning facilities or services. Abandonment of FERC-regulated natural gas pipelines or storage facilities, either in place or by removal, must follow FERC's regulations.

Where removal of a section of existing pipeline is required, construction activities typically proceed in a construction sequence similar to what has been described above in Section 3.5, except that instead of the pipeline installation step, the existing pipeline would be cut and removed from the trench. If the pipeline removal is associated with a lift-and-relay project or a replacement, then the new pipeline installation would follow the removal of the old pipe. Pipe that is abandoned by removal will be handled, taken off-site and properly disposed of or recycled in accordance with Company procedures.

When a pipeline is abandoned in place, typically work involves only relatively small excavations to remove above-ground appurtenances and meters, as well as expose the pipe in certain locations, cut it, fill with grout or blanket gas and cap the ends of the pipe, in accordance with agency and Company requirements.

Mitigation measures for pipeline abandonment and removal activities, such as erosion control measures, will follow the same requirements outlined within the E&SCP for pipeline installation in order to minimize erosion and enhance revegetation, as well as mitigate the extent and duration of project-related disturbance to wetlands and waterbodies.

## **3.6 ROW RESTORATION & FINAL CLEANUP**

Restoration of the ROW will begin after pipeline construction activities have been completed. Restoration measures include the re-establishment of final grades and drainage patterns as well as the installation of permanent erosion and sediment control devices to minimize post-construction erosion. Residential areas will be restored in accordance with Section 4.3.3. Property shall be restored as close to its preconstruction condition as practical unless otherwise specified by the landowner.

1. The Contractor shall make every reasonable effort to complete final cleanup of an area (including final grading, topsoil replacement and installation of permanent erosion control structures) within 20 days after backfilling the trench in that area (within 10 days in residential areas). If seasonal or other weather conditions prevent compliance with these timeframes, continue to inspect and maintain temporary erosion and sediment controls (i.e. temporary slope breakers, sediment barriers, and mulch) until conditions allow completion of cleanup. If construction or restoration unexpectedly continues into the winter season, follow the requirements of Frozen Conditions & Winter Construction, Section 3.6.4.
2. Seed all disturbed soils within 6 working days of final grading, weather and soil conditions permitting.
3. If construction or restoration unexpectedly cannot be completed and is delayed until the next recommended growing season, the winter stabilization measures shall be followed.
4. Grade the ROW to pre-construction contours, with the exception of the installation of any permanent measures required herein.
5. Spread segregated topsoil back across the graded ROW to its original profile.
6. Remove excess rock from at least the top 12 inches of soil in all cultivated or rotated cropland, managed pastures, hayfields, residential areas, as well as other areas at the landowner's request. The size, density, and distribution of rock on the construction ROW shall be similar to adjacent areas not disturbed by construction. The landowner or land managing agency may approve other provisions in writing.
7. A travel lane may be left open temporarily to allow access by construction traffic if the temporary erosion and sediment control structures are installed, regularly inspected and maintained. When access is no longer required, the travel lane must be removed and the ROW restored.
8. Remove all construction debris (used filter bags, skids, trash, etc.) from all construction work areas unless the landowner or land managing agency approves leaving material onsite for beneficial reuse, stabilization, or habitat restoration. Grade or till the ROW to leave the soil in the proper condition for planting.

### **3.6.1 Permanent Erosion Control**

#### **3.6.1.1 Permanent Slope Breakers**

Permanent slope breakers are intended to reduce runoff velocity, divert water off the construction ROW, and prevent sediment deposition into sensitive resources. Permanent slope breakers will be constructed of compacted soil (Figure EC-8). Stone or some functional equivalent may be used when approved by the Company.

- a. Construct and maintain permanent slope breakers in all areas, except cultivated areas and lawns, unless requested by the landowner, at the locations shown on the construction drawings.

- b. Use spacing recommendations obtained from the local soil conservation authority or land managing agency. If not shown on the construction drawings or in the absence of written recommendations, use the following spacing (same as temporary slope breaker spacing) unless closer spacing is necessary to avoid excessive erosion on the construction ROW:

<u>Slope (%)</u>	<u>Spacing (feet)</u>
< 5	No structure
5 – 15	300
> 15 – 30	200
> 30	100

- c. A permanent trench breaker will be located immediately upslope of the slope breaker.
- d. Install permanent slope breakers across the construction ROW at the base of slopes adjacent to roads. When the ROW parallels an existing utility ROW, permanent slope breakers may be installed to match existing slope breakers on the adjacent undisturbed utility ROW.
- e. Install permanent slope breakers across the construction ROW at the base of slopes greater than 5% that are less than 50 feet from a wetland or waterbody, or as needed to prevent sediment transport into a wetland or waterbody.
- f. Construct slope breakers with a 2 to 8 percent outslope to divert surface flow to a stable vegetative area without causing water to pool or erode behind the slope breaker. In the absence of a stable vegetative area, install an energy-dissipating device at the end of the slope breaker.
- g. Slope breakers may extend slightly (about 4 feet) beyond the edge of the construction ROW to effectively drain water off the disturbed area. Where slope breakers extend beyond the edge of the construction ROW, they are subject to compliance with all applicable survey and permit requirements.
- h. Install chevron-style slope breakers on slopes as appropriate (Figure EC-9).
- i. Where drainage is insufficient in upland areas, install a rock-lined drainage swale as approved by the EI. The drainage swale is generally 8 feet wide and a maximum of 18-24 inches deep (Figure EC-4).

### 3.6.1.2 Erosion Control Fabric / Blankets

Erosion control fabric or blankets are used during restoration, including as mulch, to slow down stormwater and stabilize soil until vegetation becomes established. Examples of these erosion controls include jute thatching or bonded fiber blankets. Do not use synthetic monofilament mesh/netted erosion control materials in areas designated as

sensitive wildlife habitat, unless the product is specifically designed to minimize harm to wildlife.

Install erosion control fabric or blankets where necessary or as recommended by the EI

- a. at slope breaker outlets and drainage swales (Figure EC-7, EC-8 and EC-4);
- b. on slopes adjacent to roads or waterbodies (Figure EC-14); and
- c. on waterbody banks at the time of final bank recontouring (Figure WC-5).

Anchor the erosion control fabric or blanket with staples or other appropriate devices in accordance with the manufacturers' recommendations (Figure EC-13). Evaluate flow conditions to determine if erosion control fabric is suitable as an effective vegetation stabilization technique on waterbody banks. High-velocity erosion control fabric should be used on the swale side of permanent slope breakers.

### 3.6.2 Revegetation and Seeding

Successful revegetation of soils disturbed by project-related activities is essential. Seeding will be conducted using the following requirements:

1. Fertilize and add soil pH modifiers in accordance with the recommendations in Appendix C. Incorporate recommended soil pH modifier and fertilizer into the top 2 inches of soil as soon as practicable after application;
2. Seed all disturbed areas within 6 working days of final grading, weather and soil conditions permitting;
3. Prepare seedbed in disturbed areas to a depth of 3 to 4 inches to provide a firm seedbed. When hydroseeding, scarify the seedbed to facilitate lodging and germination of seed;
4. Seed disturbed areas in accordance with the seed mixes, rates, and dates in Appendix C, except in upland areas where landowners or a land management agency may request alternative seed mixes, however, seeding is not required in cultivated croplands unless requested by the landowner;
5. Perform seeding of permanent vegetation within the recommended seeding dates as outlined in Appendix C. If seeding cannot be done within those dates, use appropriate temporary erosion control measures discussed in Section 3.5.2 and perform seeding of permanent vegetation at the beginning of the next recommended seeding season. Dormant seeding or temporary seeding of annual species may also be used, if necessary, to establish cover, as approved by the EI. Mulch in accordance with Section 3.6.3. Lawns may be seeded on a schedule established with the landowner;
6. Base seeding rates on Pure Live Seed (PLS);
7. Use seed within 12 months of seed testing;

8. Treat legume seed with an inoculant specific to the species using the manufacturer's recommended rate of inoculant appropriate for the seeding method (broadcast, drill, or hydroseeding); and,
9. Uniformly apply and cover seed in accordance with the appropriate seed mix from Appendix C, in the absence of any recommendations from the local soil conservation authorities, landowner, or land managing agency to the contrary.
  - a. A seed drill equipped with a cultipacker is preferred for application but, where permitted by regulatory agencies, broadcast or hydroseeding can be used at double the recommended seeding rates.
  - b. Where seed is broadcast, firm the seedbed with a cultipacker or roller after seeding.
  - c. In rocky soils, or where site conditions may limit the effectiveness of this equipment, other alternatives may be appropriate (e.g., use of a chain drag) to lightly cover seed after application, as approved by the EI.

### 3.6.3 Mulch

Mulch is intended to stabilize the soil surface and shall consist of weed-free straw, wood fiber hydromulch, erosion control fabric or some functional equivalent as approved by the EI and Chief Inspector.

1. Mulch all disturbed upland areas (except cultivated cropland) **before** seeding if:
  - a. Final cleanup, including final grading and installation of permanent erosion control measures, is not completed in an area within 20 days after the trench in that area is backfilled (10 days in residential areas); or
  - b. Construction or restoration activity is interrupted for extended periods, such as when seeding cannot be completed due to seeding period restrictions.

NOTE: When mulching before seeding, increase mulch application on all slopes within 100 feet of waterbodies and wetlands to a rate of 3 tons/acre of straw or equivalent.

2. Apply mulch on all slopes (except in cultivated cropland) concurrent with or immediately after seeding, where necessary, to stabilize the soil surface and to reduce wind and water erosion. Spread mulch uniformly over the ROW at a rate of 2 tons/acre of straw or equivalent.
3. Mulch with woodchips only under the following conditions with prior approval from the Chief Inspector or the EI:
  - a. Do not use more than 1 ton/acre; and
  - b. Add the equivalent of 11 lbs/acre available nitrogen (at least 50% of which is slow release).
4. Ensure that mulch is anchored to minimize loss by wind and water. Anchoring may be achieved by wet soil conditions, when approved by the EI, mechanical means, or use of liquid mulch binders.

5. When anchoring with liquid mulch binders, use rates recommended by the manufacturer. Do not use liquid mulch binders within 100 feet of wetlands and waterbodies, except where the product is certified environmentally non-toxic by the appropriate state or federal agency or independent standards-setting organization.
6. If used, install erosion control fabric or blankets in accordance with Section 3.6.1.2.

#### **3.6.4 Frozen Conditions & Winter Construction**

Winter weather may not provide suitable conditions for soil handling or restoration of disturbed areas. In the event that the construction occurs too late in the year for cleanup activities to adequately proceed or if construction is planned to occur during winter weather conditions, the Company will develop a project-specific Winter Construction Plan that addresses:

- Winter construction procedures (e.g., snow handling and removal, access road construction and maintenance, soil handling under saturated or frozen conditions, topsoil stripping);
- Stabilization and monitoring procedures if ground conditions will delay restoration until the following spring (e.g., mulching and erosion controls, inspection and reporting, stormwater control during spring thaw conditions); and,
- Final restoration procedures (e.g., subsidence and compaction repair, topsoil replacement, seeding).

The Winter Construction Plan will be provided within the project-specific Clearance Package / Permit Book. Section 7(c) and prior notice projects are required to file the Winter Construction Plan for the review and written approval by the FERC. (The requirement to file a plan does not apply to projects constructed under the automatic authorization provisions in the FERC's regulations.)

#### **3.6.5 Unauthorized Vehicle Access to ROW**

The Company will offer to install and maintain measures to control unauthorized vehicle access to the ROW based on requests by the manager or owner of forested lands. These measures may include:

- Signs;
- Fences with locking gates;
- Permanent access roads;
- Slash and timber barriers, pipe barriers, or a line of boulders across the ROW; or
- Conifers or other appropriate shrubs with a mature height of 4 feet or less across the ROW.

### **3.7 ABOVEGROUND FACILITY CONSTRUCTION**

Construction at aboveground facilities, including compressor stations, meter stations, valve sites, and other facilities, will follow the same best management practices identified for pipeline installation and removal on

the ROW. Work activities in this category can include installation of new aboveground facilities, modification or relocation of facilities at existing compressor station sites, upgrades or installations at existing meter station sites, construction of new receipt or delivery points, and a variety of other activities. Certain project types covered in this section may trigger additional stormwater permitting. Check with the ECP Lead to ensure that all stormwater requirements are met prior to construction.

1. Aboveground facilities shall not be located in any wetland, except as permitted or where the location of such facilities outside of wetlands would prohibit compliance with U.S.DOT regulations.
2. Install temporary sediment barriers at the base of slopes adjacent to roads and at waterbodies and wetlands in accordance with Sections 5.1.4 and 6.3 respectively.
3. Inspect temporary sediment barriers daily in areas of active construction to ensure proper functioning and maintenance. In other areas with no construction or equipment operation, sediment barriers will be inspected and maintained on a weekly basis throughout construction, and within 24 hours of each 0.5 inch of rainfall. Conduct an inspection within 24 hours once a storm event has produced 0.5 inch of rainfall, even if the storm event is still continuing.
4. If a waterbody is present on or immediately adjacent to an existing facility property where work is being conducted, install sediment barriers as necessary along the edge of the construction area to contain spoil and sediment within the work area.
5. All extra work areas should be located at least 50 feet away from the water's edge of a waterbody or a wetland, except where the adjacent upland consists of cultivated or rotated cropland or other disturbed land. FERC approval is necessary for the use of work areas if these setback conditions cannot be met.
6. Wetland boundaries and buffers (e.g., extra work area setbacks, refueling restrictions) must be clearly marked in the field with signs and /or highly visible flagging until construction-related ground disturbing activities are complete.
7. When work is required within a wetland at an existing facility, and standing water or saturated soils are present, or if construction equipment causes ruts or mixing of the topsoil and subsoil in wetlands, use low-ground-weight construction equipment or operate normal equipment on timber riprap, prefabricated equipment mats or terra mats. Do not use more than two layers of timber riprap to stabilize the work area.
8. Maintain all temporary sediment barriers in place until permanent revegetation measures are successful or the upland areas adjacent to wetlands, waterbodies and roads are stabilized.
9. Remove temporary sediment barriers from an area when replaced by permanent erosion or sediment control measures or when the area has been successfully restored as specified in Section 8.1.
10. Temporary slope breakers are to be installed on all disturbed areas as necessary to avoid excessive erosion as described in Section 3.5.4.

11. Where required for work in wetlands (except areas where standing water is present or soils are saturated) segregate topsoil as described in Section 3.5.3.1.
12. Place spoil at least 10 feet upgradient from the edge of waterbodies or as indicated on construction drawings. Spoil will be contained with erosion and sediment control devices to prevent spoil materials or silt-laden water from transferring into waterbodies and wetlands or off of the facility property.
13. If required, dewatering should be conducted as described in Section 3.5.6.
14. The Contractor shall make every reasonable effort to complete final cleanup of an area (including final grading and installation of permanent erosion control structures) within 20 days after ground disturbing activities are completed. If seasonal or other weather conditions prevent compliance with these time frames, continue to inspect and maintain temporary erosion and sediment controls (temporary slope breakers and sediment barriers) until conditions allow completion of cleanup. Cleanup shall be conducted in accordance with Section 3.6 of this document.
15. Grade to contours shown on construction drawings or site plans or return grade to pre-construction contours.
16. New gravel, stone and paving at the site shall be placed in accordance with construction drawings. No additional gravel, stone, or paving shall be added without prior approval by ECP.
17. Install permanent erosion controls and post-construction stormwater measures at the locations shown on the construction drawings.
18. Disturbed soils will be seeded within 6 working days of final grading, weather and soil conditions permitting, unless permit conditions indicate otherwise.
19. Remove all timber riprap and prefabricated equipment mats in any wetlands upon completion of construction.

## 4. SPECIAL CONSTRUCTION METHODS

The Company will utilize the following specialized construction procedures for agricultural areas, road crossings, and residential areas along the pipeline project, when applicable. The project construction drawings, Line Lists, and Construction Contract will indicate the locations where specialized construction methods will be used.

### 4.1 AGRICULTURAL AREAS

The following sections identify construction procedures and best practices for activities within actively cultivated or rotated land used for the production of crops including but not limited to corn, grains, orchards, vineyards and hayfields.

#### 4.1.1 Drain Tiles

Develop procedures for constructing through drain-tiled areas and repairing drain tiles after construction. Engage qualified drain tile specialists, as needed, to conduct or monitor repairs to drain tile systems affected by construction. Use drain tile specialist from the project area, if available.

1. Attempt to locate existing drain tiles.
2. Probe all drainage tile systems within the area of disturbance to check for damage.
3. Ensure that the depth of cover over the new pipeline is sufficient to avoid interference with drain tile systems (existing or proposed). For adjacent pipeline loops in agricultural areas, install the new pipeline with at least the same depth of cover as the existing pipeline(s).
4. Repair damaged drain tiles to their original or better condition (Figure SU-1). Filter-covered drain tiles may not be used unless the local soil conservation authorities and the landowner agree in writing prior to construction.

#### 4.1.2 Irrigation

Maintain water flow in crop irrigation systems, unless shutoff is coordinated with affected parties. Repair any damage to irrigation systems as soon as practical.

#### 4.1.3 Soil Compaction Mitigation & Restoration

The following measures are to be employed during decompaction and restoration of soil within agricultural areas disturbed by construction activities:

1. In agricultural areas, test topsoil and subsoil disturbed by construction activities for compaction at regular intervals. Use penetrometers or other appropriate devices to conduct tests. In order to approximate preconstruction conditions, conduct tests on the same soil type under similar moisture conditions in undisturbed areas.
2. Plow severely compacted soils with a paraplow or other deep tillage implement;
  - a. In areas where topsoil has been segregated, plow the subsoil before replacing the segregated topsoil.

- b. If subsequent construction and cleanup activities result in further compaction, conduct additional tilling.
3. Soils imported for use within agricultural areas are to be certified as free of noxious weeds and soil pests, unless otherwise approved by the landowner.
4. Remove excess rock from at least the top 12 inches of soil in all cultivated or rotated cropland, managed pastures, hayfields. The size, density, and distribution of rock on the construction work area shall be similar to adjacent areas not disturbed by construction. The landowner or land management agency may approve other provisions in writing.

## 4.2 ROAD CROSSINGS

The "open cut" method is typically used when installing the pipeline across small roads (Figure RD-4). Traffic is diverted while the trench is excavated across the road and the pipeline is installed. An open cut crossing may involve closing the road to all traffic and constructing an adequate detour around the crossing area, or excavating one-half of the road at a time allowing through traffic to be maintained. Any detour constructed around the crossing area must remain within the approved construction workspace. After completing the crossing, all backfill is compacted, the road bed is repaired and the road surface is replaced.

Bores are often used to install the pipeline across highways, major roads with heavy traffic, and railroads (Figure RD-5), unless the crossing permit allows an open cut crossing. Similar to a directional drill, as discussed in Section 4.4, the road bore is accomplished with a horizontal drill rig or boring machine. The boring machine drills a hole under the road to allow insertion of the pipe. Typically, a dummy pipe section is pulled through which is welded to the line pipe. The dummy pipe is pulled back through placing the line pipe in the crossing. In some instances, a casing (another larger pipe) is installed in the hole and the pipeline is inserted inside the casing. Casings typically are not installed today, although some states require casings on rail crossings. Casings also may be used in soils where it is difficult to pull pipe. The benefit of the road bore is that it allows installation of the pipeline without disrupting traffic.

Access roads shall be used and maintained in accordance with Section 3.2.

## 4.3 RESIDENTIAL AREAS

Specialized construction procedures will be utilized in areas of heavy residential or commercial/ industrial congestion where residences or business establishments lie within 50 feet from the edge of the construction ROW.

1. Install safety fence at the edge of the construction ROW for a distance of 100 feet on either side of the residence or business establishment.
2. For a distance of 100 feet on either side any residence or business establishment, maintain a minimum distance of 25 feet between any structure and the edge of the construction work area. If a distance of 25 feet cannot be maintained, refer to Section 4.3.2.
3. If crushed stone/rock access pads are used in residential areas, rock shall be placed on nonwoven synthetic geotextile fabric to facilitate rock removal after construction.

4. Attempt to leave mature trees and landscaping intact within the construction work area unless the trees and landscaping interfere with the installation techniques or present unsafe working conditions, or as specified in landowner agreements.
5. Prevent the mixing of subsoil and topsoil by implementing segregation methods in all residential areas, except where the topsoil is being replaced, as stipulated in Section 3.5.3.1, unless the landowner or land managing agency specifically approves otherwise.

In addition to the aforementioned specialized procedures, smaller "spreads" of labor and equipment, operating independent of the mainline work force, will utilize either the stove pipe or drag section pipeline construction techniques in those areas of congestion where a minimum distance of 25 feet cannot be maintained between the residence (or business establishment) and the edge of the construction work area. In no case shall the temporary work area be located within 10 feet of a residence unless the landowner agrees in writing, or the area is within the existing maintained ROW.

The following techniques shall be utilized for a distance of 100 feet on either side of the residence or business establishment at the locations identified in the Company Construction Contract and/or Line List. Refer to site-specific residential construction plans, as applicable.

#### **4.3.1 Stove Pipe Technique**

The stove pipe construction technique is a less efficient alternative to the mainline method of construction, typically used when the pipeline is to be installed in very close proximity to an existing structure or when an open trench would adversely impact a commercial/industrial establishment. The technique involves installing one joint of pipe at a time whereby the welding, weld inspection, and coating activities are all performed in the open trench. At the end of each day after the pipe is lowered-in, the trench is backfilled and/or covered with steel plates or timber mats. The length of excavation performed each day cannot exceed the amount of pipe installed.

#### **4.3.2 Drag Section Technique**

The drag section construction technique, while less efficient than the mainline method, is normally preferred over the stove pipe alternative. This technique involves the trenching, installation, and backfill of a prefabricated length of pipe containing several segments all in one day. At the end of each day after the pipe is lowered-in, the trench is backfilled and/or covered with steel plates or timber mats. Use of the drag section technique will typically require adequate staging areas outside of the residential and/or commercial/industrial congestion for assembly of the prefabricated sections.

#### **4.3.3 Residential Area Cleanup and Restoration**

Restore all lawn areas and landscaping immediately following cleanup operations, or as specified in landowner agreements, including

1. Perform appropriate soil compaction mitigation in severely compacted residential areas.

2. Remove excess rock from at least the top 12 inches of soil in all cultivated or rotated cropland, managed pastures, hayfields. The size, density, and distribution of rock on the construction work area shall be similar to adjacent areas not disturbed by construction. The landowner or land management agency may approve other provisions in writing.
3. Importation of topsoil is an acceptable alternative to topsoil segregation. Soils imported for use within residential areas are to be certified as free of noxious weeds and soil pests, unless otherwise approved by the landowner.
4. Reseed all disturbed lawns with a seed mixture acceptable to landowner or comparable to the adjoining lawn.

In residential areas, complete final grading, topsoil replacement, and installation of permanent erosion control structures within 10 days after backfilling the trench. Mulch all disturbed areas before seeding if final grading and installation of permanent erosion control measures will not be completed within 10 days after the trench in that area is backfilled in residential areas. If seasonal or other weather conditions prevent compliance with these time frames, maintain temporary erosion controls (i.e., temporary slope breakers, sediment barriers, and mulch) until conditions allow completion of cleanup.

Landowners shall be compensated for damages in a fair and reasonable manner, and as specified in the damage provision within the controlling easement on each property.

#### **4.4 HORIZONTAL DIRECTIONAL DRILL METHOD**

Horizontal Directional Drilling (HDD) is a trenchless crossing method that can help avoid direct impacts to sensitive resources (e.g., waterbodies and wetlands) or infrastructure (e.g., roads and railways) by directionally drilling beneath them. HDD installation typically is carried out in three stages:

1. Directional drilling of a small diameter pilot hole;
2. Enlarging the pilot hole to a sufficient diameter to accommodate the pipeline; and,
3. Pulling the prefabricated pipeline, or pull string, into the enlarged bore hole.

For each waterbody or wetland that would be crossed using the HDD method, the Company will prepare a project-specific HDD Plan that includes:

- Site-specific construction diagrams that show the location of mud pits, pipe assembly areas, and all areas to be disturbed or cleared for construction;
- Justification that disturbed areas are limited to the minimum needed to construct the crossing;
- Identification of any aboveground disturbance or clearing between the HDD entry and exit workspaces during construction;
- A description of how an inadvertent release of drilling mud would be contained and cleaned up; and
- A contingency plan for crossing the waterbody or wetland in the event the HDD is unsuccessful and how the abandoned drill hole would be sealed, if necessary.

The HDD Plan will be provided within the project-specific Clearance Package / Permit Book.



Section 7(c) and prior notice projects are required to file HDD plans for the review and written approval by the FERC. (This requirement to file a plan does not apply to projects constructed under the automatic authorization provisions in the FERC's regulations.)

During post-construction maintenance activities, do not conduct any routine vegetation mowing or clearing in riparian areas or wetlands that are between HDD entry and exit points.

## 5. WATERBODY CROSSINGS

The intent of these procedures is to minimize the extent and duration of project related disturbances within waterbodies. The following section describes the construction procedures and mitigation measures that will be used for pipeline installations at waterbodies. The length of the crossing, the sensitivity of the area, existing conditions at the time of the crossing, and permit requirements will determine the most appropriate measures to be used.

The *Waterbody Reference Citing FERC Requirements* in Appendix B summarizes general waterbody crossing methods and requirements identified in the FERC Procedures. These tables provide a brief reference of the restrictions on construction techniques for waterbody crossings; equipment bridges; construction time windows. However, as more stringent agency specific requirements may exist, refer to the Clearance Package / Permit Book for project-specific requirements.

### 5.1 GENERAL WATERBODY PROCEDURES

Pipeline construction across waterbody channels may result in short term water quality impacts. The following general procedures are to be followed to minimize or avoid impacts at waterbody crossings:

1. Crossings of waterbodies may proceed using standard upland construction techniques when they are dry or frozen and not flowing provided that the EI verifies that water is unlikely to flow between initial disturbance and final stabilization of the feature. In the event of perceptible flow, all applicable requirements of Section 5 must be followed.
2. Construct crossings as close to perpendicular to the axis of the waterbody channel as engineering and routing conditions permit.
3. Where waterbodies meander or have multiple channels, route the pipeline to minimize the number of waterbody crossings.
4. Perform mobilization of construction equipment, trench excavation, and backfilling in a manner that will minimize the potential for erosion and sedimentation within the waterbody channel.
5. Locate all extra work areas, such as staging and additional spoil storage areas, at least 50 feet away from water's edge, except where the adjacent upland consists of cultivated or rotated cropland or other disturbed land. Site-specific written approval by FERC is required for all extra work areas with a less than 50-foot setback and associated measures to be used to ensure the waterbody is adequately protected.
6. Implement erosion control measures to confine water quality impacts within the immediate construction area and to minimize impacts to downstream areas.
7. Place all spoil from the waterbody within the construction ROW at least 10 feet from the water's edge or in the extra work areas shown on the construction drawings.
8. Maintain adequate flow rates to protect aquatic life and prevent the interruption of existing downstream uses.
9. Dewater trench in accordance with the procedures described in Section 3.5.6.

### 5.1.1 Time Windows for Instream Work

Unless expressly permitted or further restricted by the appropriate federal or state agency in writing on a site-specific basis, instream work must occur during the following time windows:

- Coldwater fisheries – June 1 through September 30; and
- Coolwater and warmwater fisheries – June 1 through November 30.

Installation or removal of equipment bridges above the top of bank is not subject to the aforementioned time windows.

### 5.1.2 Equipment Bridges

Equipment bridges may be installed and used where needed to allow equipment access across waterbodies.

1. Until the equipment bridge is installed, only clearing equipment and equipment necessary for installation of equipment bridges may cross the waterbody, and the number of crossings shall be limited to one crossing per piece of equipment, unless otherwise authorized by the appropriate permitting agency. EI approval is required prior to equipment crossing a waterbody without an equipment bridge.
2. Construct and maintain equipment bridges that allow unrestricted flow and prevent sediment from entering the waterbody. The Construction Contract agreement and/or permit conditions may specify the type of bridge to be used. Examples of bridges are provided below:
  - a. Equipment pads with or without culvert(s), as illustrated in Figure BR-1;
  - b. Clean crushed stone and culvert(s), as illustrated in Figure BR-2;
  - c. Flexi-float or portable bridges, as illustrated in Figure BR-3;
  - d. Double equipment pads, geotextile fabric and sideboards with or without culvert(s); or
  - e. Railroad car bridges without culverts.
3. Design and maintain each equipment bridge to withstand the highest flows that would occur. Align culverts/flumes to prevent bank erosion or streambed scour. If necessary, install energy dissipating devices downstream of culverts.
4. Do not use soil to construct or stabilize equipment bridges.
5. Design and maintain equipment bridges to prevent sediment from entering the waterbody.
6. Remove temporary equipment bridges as soon as practicable after permanent seeding.
7. If there will be more than 1 month between final cleanup and the beginning of permanent seeding and reasonable alternative access to the ROW is available, remove temporary equipment bridges as soon as practicable after final cleanup.

8. Obtain any necessary approval or authorization from the COE and/or the appropriate state agency for temporary and permanent bridges.

### 5.1.3 Clearing and Grading near Waterbodies

1. Confine construction activities and ground disturbance to the construction ROW boundaries, as shown on the construction drawings. Restrict extra work areas (such as staging areas and additional spoil storage areas) to only those shown on the construction drawings.
2. If the pipeline parallels a waterbody, maintain at least 15 feet of undisturbed vegetation between the waterbody (and any adjacent wetland) and the ROW except where maintaining this offset will result in greater environmental impact.
3. Clear the ROW adjacent to all waterbodies *up to the high water bank* (where discernible). *Within 10 feet of the high water bank*, trees shall be cut to ground level and with little to no ground disturbance. **Do not grub** this 10-foot vegetative strip with equipment.
4. Immediately remove all cut trees and branches that inadvertently fall into a waterbody and stockpile in an upland area within the construction ROW for disposal.
5. Grade the ROW adjacent to waterbodies *up to within 10 feet of the high water bank*, leaving an ungrubbed vegetative strip intact.
6. Clearing and grading operations may proceed through the 10-foot vegetative strip **only on the working side of the ROW** in order to install the equipment bridge and travel lane. Use temporary sediment barriers to prevent the flow of bank spoil into the waterbody.

### 5.1.4 Temporary Erosion and Sediment Controls at Waterbodies

Install sediment barriers immediately after initial disturbance of the waterbody or adjacent upland. Sediment barriers must be properly maintained throughout construction and repaired or reinstalled as necessary (such as after backfilling of the trench), until replacement by permanent erosion controls or restoration of adjacent upland areas is complete. Temporary erosion and sediment control measures are addressed in more detail in Section 3.5, however, the following specific measures must be implemented at stream crossings:

1. Install sediment barriers across the entire construction ROW at all waterbody crossings, where necessary to prevent the flow of sediments into the waterbody.
2. Install sediment barriers along the edge of the construction ROW as necessary to contain spoil within the construction ROW and prevent sediment flow into the waterbody where waterbodies are adjacent to the construction ROW or parallel to the construction ROW and the ROW slopes toward the waterbody.
3. Removable or temporary sediment barriers, such as slope breakers or drivable berms as described in Section 3.5.4, may be used in lieu of sediment barriers in front of equipment bridges or timber mats across the travel lane. Removable sediment barriers can be removed during the construction day, but must be reinstalled after construction has stopped for the day or whenever heavy precipitation is imminent.

4. Use temporary trench plugs at all waterbody crossings, as necessary, to prevent diversion of water into upland portions of the pipeline trench and to keep any accumulated trench water out of the waterbody. Trench plugs shall be of sufficient size to withstand upslope water pressure.

## 5.2 TYPES OF WATERBODY CROSSING METHODS

Waterbody crossing techniques allowed for use on a project will be determined by agency consultations and permits. Construction at waterbodies will be conducted using two principal crossing methods, a “dry” crossing and a “wet” crossing. The “dry” or “dry-ditch” crossing procedure is further divided into a flume crossing and a dam-and-pump crossing methods. These methods are designed to maintain downstream flow at all times and to isolate the construction zone from the stream flow by channeling the water flow through a flume pipe or by damming the flow and pumping the water around the construction area. The overall objective is to minimize siltation of the waterbody and to facilitate trench excavation of saturated spoil. The two “dry” crossings are further described below in Sections 5.2.1 and 5.2.2.

The “wet” or “open-cut” crossing method involves trenching in the waterbody without isolating the construction zone from the stream flow. The objective of this method is to complete the waterbody crossing as quickly as practical in order to minimize the duration of impacts to aquatic resources. The wet crossing method is further described below in Section 5.2.3.

All streams, their classifications, timing windows, applicable permits and crossing procedures will be identified in the project-specific Clearance Package/Permit Book and on the construction drawings. Unless approved otherwise by the appropriate federal or state agency, pipeline construction and installation must occur using one of the two “dry” crossing methods for waterbodies state-designated as either coldwater or significant coolwater or warmwater fisheries, or federally designated as critical habitat. The flume and dam-and-pump crossing methods are applicable to waterbodies up to 30 feet wide (possibly wider depending on flow volume and rate) at the water’s edge at the time of construction.

### 5.2.1 Flume Crossing

The flume crossing method utilizes a flume pipe(s) to transport stream flow across the disturbed area and allows trenching to be done in drier conditions (Figure WC-3). The flume pipe(s) installed across the trench will be sized to accommodate anticipated stream flows. Flumes are generally not recommended for use on a waterbody with a broad unconfined channel, unstable banks, a permeable substrate, excessive stream flow, or where the installation and construction of the flume crossing will adversely affect the bed or banks of the stream.

The flume waterbody crossing shall be installed as follows:

1. Install flume pipe(s) after blasting and other rock breaking measures (if required), but before trenching;
2. Properly align flume pipe(s) to prevent bank erosion and streambed scour;
3. Use sand bags or equivalent dam diversion structure to provide a seal at either end of the flume to channel water flow (some modifications to the stream bottom may be required to achieve an effective seal);

4. **Do not remove flume pipe** during trenching, pipe laying (thread pipe underneath the flume pipe(s)), or backfilling activities, or initial streambed restoration efforts, except for crossings where a dam-and-pump method (as described in Section 5.2.2 below) has been established as an alternative measure to redirect stream flow; and
5. Remove all flume pipes and dams that are not also part of the equipment bridge as soon as final cleanup of the stream bed and bank is complete.

### 5.2.2 Dam-and-Pump Crossing

The dam-and-pump crossing method is presented as an alternative dry crossing procedure to the flume crossing (in limited cases, it may be used in combination with a flume crossing). The dam-and-pump method is accomplished by utilizing pumps to transport stream flow across the disturbed area (Figure WC-4). This method involves placing sandbags across the existing stream channel upstream from the proposed crossing to stop water flow and downstream from the crossing to isolate the work area. Pumps are used to pump the water across the disturbed area and back into the stream further downstream.

The dam-and-pump procedure allows for more space and flexibility during trenching and pipe installation, which shortens the duration of time spent at the waterbody. The dam-and-pump method may be used for crossings of waterbodies where pumps can adequately transfer stream flow volumes around the work area, and where there are no concerns about sensitive species passage.

The dam-and-pump crossing method shall be installed as follows:

1. Install and properly seal sandbags at the upstream and downstream location of the crossing;
2. Create an in-stream sump using sandbags if a natural sump is unavailable for the intake hose;
3. Initiate pumping of the stream around the work area prior to excavating the trench;
4. Monitor dam and pumps at all times to ensure proper operation until the waterbody crossing is completed; and,
5. Remove the sandbag dams, pumps and hoses and return normal flow back to the waterbody following installation and restoration of the streambed.

Implementation of the dam-and-pump crossing method will meet the following performance criteria:

- Use sufficient pumps, including onsite backup pumps, to maintain downstream flows;
- Construct dams with materials that prevent sediment and other pollutants from entering the waterbody (e.g., sandbags or clean gravel with plastic liner);
- Screen all intake hoses to minimize the entrainment of fish and other aquatic life
- Prevent streambed scour at pump discharge; and
- Continuously monitor the dam and pumps to ensure proper operation throughout the waterbody crossing.

### 5.2.3 Wet Crossing

Open-cut crossings involve excavating a trench for the pipeline across the bottom of the waterbody to be crossed (Figure WC-2). Depending on the depth of the water, construction equipment may be placed on barges or other floating platforms to excavate the pipe trench.

This construction technique is typically used to cross waterbodies that are not state-designated, such as ephemeral drainage ditches, and ephemeral and intermittent streams, as well as intermediate and major waterbodies with substantial flows that cannot be effectively flumed or pumped around the construction zone using one of the dry crossing techniques.

## 5.3 FERC WATERBODY CLASSIFICATIONS

In the FERC Procedures, a “waterbody” is defined to include any natural or artificial stream, river, or drainage with perceptible flow at the time of crossing, and other permanent waterbodies such as ponds and lakes. Waterbodies have been further divided into three classifications by FERC depending on the width of the feature, which dictate construction limitations or requirements.

### 5.3.1 Minor Waterbodies

FERC defines a “minor waterbody” as a waterbody less than or equal to 10 feet wide at the water’s edge at the time of crossing. Minor waterbodies shall be crossed in accordance with the following requirements:

1. All spoil from minor waterbody crossings must be placed in the construction ROW at least 10 feet from the water’s edge or in additional extra work areas as described above in Section 5.1.
2. Unless approved otherwise by the appropriate federal or state agency, utilize a dry crossing construction technique to install crossings at all minor waterbodies that are state-designated fisheries or federally designated as critical habitat, as identified in the Clearance Package/ Permit Book (Figures WC-3 or WC-4).
  - a. All construction equipment must use an equipment bridge to cross state-designated fisheries as specified in Section 5.1.2.
3. Where a dry-ditch crossing is not required, minor waterbodies may be crossed using the wet crossing method, with the following restrictions:
  - a. Except for blasting and other rock breaking measures, complete instream construction activities (including trenching, pipe installation, backfill, and restoration of the streambed contours) within 24 hours. Streambanks and unconsolidated streambeds may require additional restoration after this period;
  - b. Limit use of equipment operating in the waterbody to that needed to construct the crossing;
  - c. If a flume is installed within the waterbody during mainline activities, it can be removed just prior to lowering in the pipeline (The 24-hour timeframe starts as soon as the flume is removed.); and,

- d. Equipment bridges are not required at minor waterbodies that do not have a state-designated fishery classification or protected status (e.g., agricultural or intermittent drainage ditches). However, if an equipment bridge is used it must be constructed as described in Section 5.1.2.

### 5.3.2 Intermediate Waterbodies

FERC defines an "intermediate waterbody" as a waterbody greater than 10 feet wide but less than or equal to 100 feet wide at the water's edge at the time of crossing. Intermediate waterbodies shall be crossed in accordance with the following requirements:

1. All spoil from intermediate waterbody crossings must be placed in the construction ROW at least 10 feet from the water's edge or in additional extra work areas as described above in Section 5.1.
2. Unless approved otherwise by the appropriate federal or state agency, install the pipeline using a dry crossing method for crossings of waterbodies up to 30 feet wide (at the water's edge at the time of construction) that are
  - a. state-designated as either coldwater or significant coolwater or warmwater fisheries, or
  - b. federally designated as critical habitat.
3. Where a dry-ditch crossing is not required, intermediate waterbodies may be crossed using the wet crossing method, with the following restrictions:
  - a. Complete instream construction activities (not including blasting and other rock breaking measures) within 48 hours, unless site-specific conditions make completion within 48 hours infeasible;
  - b. Limit use of equipment operating in the waterbody to that needed to construct the crossing; and,
  - c. All other construction equipment must cross on an equipment bridge as specified in Section 5.1.2.

### 5.3.3 Major Waterbodies

FERC defines a "major waterbody" as a waterbody greater than 100 feet wide at the water's edge at the time of crossing. Before construction, the Company shall prepare and file for the review and written approval by the FERC a detailed, site-specific construction plan and scaled drawings identifying all areas to be disturbed by construction for each major waterbody crossing, however the scaled drawings are not required for any offshore portions of pipeline projects. (The requirement to file major waterbody crossing plans does not apply to projects constructed under the automatic authorization provisions of the FERC's regulations.) This site-specific plan must be developed in consultation with the appropriate state and federal agencies and shall include extra work areas, spoil storage areas, sediment control structures, etc., as well as mitigation for navigational issues.

Upland spoil from major waterbody crossings must be placed in the construction ROW at least 10 feet from the water's edge or in additional extra work areas as described in Section 5.2.

#### 5.4 Restoration

Restore and stabilize the waterbody banks and channel in accordance with this section.

1. Return all waterbody banks to preconstruction contours or to stable angle of repose as approved by the EI.
2. Use clean gravel or native cobbles for the upper 12 inches of trench backfill in all waterbodies identified in the Clearance Package/Permit Book as coldwater fisheries, unless otherwise specified by state-specific agency recommendations or permit conditions.
3. For wet crossings, stabilize waterbody banks and install temporary sediment barriers within 24 hours of completing the crossing.
4. For dry crossings, complete bank stabilization before returning flow to the waterbody channel.
5. Limit the use of rock riprap to areas where flow conditions preclude effective vegetation stabilization techniques such as seeding and erosion control fabric, unless otherwise specified by COE and state permits. Limit the placement of rock riprap to the slopes along the disturbed waterbody crossing. Application of riprap for bank stabilization must comply with COE, or its delegated agency, permit terms and conditions.
6. Install erosion control fabric, in accordance with Section 3.6.1.2, or a functional equivalent on waterbody banks at the time of final bank contouring (Figure EC-13, WC-5). Do not use synthetic monofilament mesh/netted erosion control materials in areas designated as sensitive wildlife habitat unless the product is specifically designed to minimize harm to wildlife.
7. Revegetate disturbed riparian areas with native species of conservation grasses, legumes and woody species similar in density to adjacent undisturbed lands.
8. In the event that final cleanup is deferred more than 20 days after the trench is backfilled, all slopes within 100 feet of waterbodies shall be mulched with 3 tons/acre of straw.
9. Remove all temporary sediment barriers when replaced by permanent erosion controls or when restoration of adjacent upland areas is successful as specified in Section 8.1.
10. Install a permanent slope breaker and a trench breaker at the base of slopes greater than 5% that are less than 50 feet from each waterbody crossed.

## 6. WETLAND CROSSINGS

The term “wetland” as used in this plan includes any area that satisfies the requirements of the current federal methodology for identifying and delineating wetlands. The requirements outlined below do not apply to wetlands in actively cultivated or rotated cropland. Standard upland protective measures, including workspace and topsoil segregation requirements, apply to these agricultural wetlands.

Wetland boundaries are identified on the construction drawings and within the Clearance Package / Permit Book. Wetlands are delineated prior to construction using current federal methodology and summarized within a wetland delineation report, which identifies the following information for all wetlands that would be affected by the construction ROW:

- Location, including pipeline milepost if crossed by centerline;
- National Wetland Inventory (NWI) classification;
- Crossing length in feet;
- Area of permanent and temporary disturbance that would occur in each wetland, sorted by NWI classification type.

### 6.1 General Wetland Procedures

Crossing procedures are to comply with COE, or its delegated agency, permit terms and conditions. Project-specific permits or authorizations issued by the COE or other appropriate agenc(ies) are provided in the Clearance Package / Permit Book. Implement the following general requirements during planning and construction near or across wetlands:

1. Route the pipeline to avoid wetland areas to the maximum extent possible.
2. If a wetland cannot be avoided or crossed by following an existing right-of-way, route the new pipeline in a manner that minimizes disturbance to wetlands. Where looping an existing pipeline, overlap the existing pipeline right-of-way with the new construction right-of-way. In addition, locate the loop line no more than 25 feet away from the existing pipeline unless site-specific constraints would adversely affect the stability of the existing pipeline.
3. Identify site-specific areas where excessively wide trenches could occur and/or where spoil piles could be difficult to maintain because existing soils lack adequate unconfined compressive strength.
4. Limit construction activity and ground disturbance in wetland areas to a construction ROW width of 75 feet or as shown on the construction drawings. Only with prior written approval from the FERC, construction ROW width within the boundaries of federally delineated wetlands may be expanded beyond 75 feet if required by site-specific topographic conditions or soil limitations.
5. All extra work areas must be located at least 50 feet away from wetland boundaries, except where the adjacent upland consists of cultivated or rotated cropland or other disturbed land. Only with prior written approval from the FERC, the Company can locate extra work areas closer than 50 feet from the wetland if site-specific conditions justify a less than 50-foot setback.

6. Aboveground facilities shall not be located in any wetland, except as permitted or where the location of such facilities outside of wetlands would prohibit compliance with U.S.DOT regulations.
7. In the event a waterbody crossing is located within or adjacent to a wetland crossing, the Company must file a site-specific crossing plan for review and obtain written approval by the FERC before construction if all measures of Sections V. and VI. of the FERC Procedures cannot be met.
8. Limit construction equipment operating in wetland areas to that needed to clear the ROW, dig the trench, fabricate and install the pipeline, backfill the trench, and restore the construction ROW. All other construction equipment shall use access roads located in upland areas to the maximum extent practical. Refer to Section 3.2 for other requirements and restrictions pertaining to access to the construction ROW or use of roads across wetlands.

## **6.2 Clearing and Grading at Wetlands**

1. Wetland boundaries and buffers (e.g., extra work area setbacks, refueling restrictions) must be clearly marked in the field with signs and /or highly visible flagging until construction-related ground disturbing activities are complete.
2. If standing water or saturated soils are present, or if construction equipment causes ruts or mixing of the topsoil and subsoil in wetlands, use low-ground-weight construction equipment or operate normal equipment on timber riprap, prefabricated equipment mats or terra mats on the working side of the ROW during clearing operations.
3. Attempt to use no more than two layers of timber riprap to stabilize the ROW. If approved by the COE, woody debris can be burned in wetlands as long as it is in accordance with state and local regulations, ensuring that all woody debris is removed for disposal.
4. Cut vegetation just above ground level and grind stumps to ground level, leaving existing root systems in place and remove any excess vegetation (e.g., wood chips). Immediately remove all cut trees, limbs and branches from the wetland and stockpile in an upland area on ROW for disposal.
5. Limit pulling of tree stumps and grading activities to directly over the trenchline. Do not grade or remove stumps or root systems from the rest of the construction ROW in wetlands unless the Chief Inspector and EI determine that safety-related construction constraints require grading or the removal of tree stumps from under the working side of the construction ROW.
6. Do not cut trees outside of the construction ROW to obtain timber for riprap or equipment mats.
7. Cleared materials, such as slash, logs, brush, and wood chips, shall not be permanently placed within wetland areas.

### 6.3 Temporary Erosion & Sediment Control at Wetlands

Install sediment barriers immediately after initial ground disturbance at the following locations:

- Within the ROW at the edge of the boundary between wetland and upland;
- At the base of slopes greater than 5% where the base of the slope is less than 50 feet from a wetland;
- Across the entire ROW immediately upslope of the wetland boundary to contain spoil within the construction ROW and prevent sediment flow into the wetland;
- Along the edge of the ROW, where the ROW slopes toward the wetland, to protect adjacent, off ROW wetland; and
- Along the edge of the ROW as necessary to contain spoil and prevent sediment from migrating outside the construction ROW in areas where a wetland is both within and adjacent to the construction ROW.

Maintain all sediment barriers throughout construction and reinstall as necessary (such as after backfilling of the trench) until replaced by permanent erosion controls or restoration of adjacent upland areas is complete in accordance with Section 8.1. Remove the sediment barriers during right-of-way cleanup.

### 6.4 Wetland Crossing Procedure

Procedures used to install a pipeline across wetlands vary depending on the level of soil stability and saturation encountered during construction. The following best management practices are to be employed during standard wetland crossings:

1. Assemble the pipeline in an upland area unless the wetland is dry enough to adequately support skids and pipe.
2. Do not use rock, soil imported from outside the wetland, tree stumps, or brush riprap to stabilize the ROW.
3. Perform topsoil segregation in accordance with Section 3.5.3.1, including segregating the top 1 foot of topsoil from the area disturbed by trenching, except in areas where standing water is present or soils are saturated. Immediately after backfilling is complete, restore the segregated topsoil to its original location.
4. If required, dewatering should be conducted as described in Section 3.5.6.
5. Minimize the length of time that topsoil is segregated and the trench is open. Do not trench the wetland until the pipeline is assembled and ready for lowering-in.
6. Use “push-pull” or “float” construction techniques to place the pipe in the trench where water and other site conditions allow (Refer to Section 6.4.1 below).

7. Install permanent trench breakers at the wetland boundaries and/or seal the trench bottom as necessary to maintain the original wetland hydrology at locations where the pipeline trench may drain a wetland.
8. Install a permanent slope breaker and a trench breaker at the base of slopes near the boundary between the wetland and adjacent upland areas for each wetland crossed.
9. Install a permanent slope breaker across the construction right-of-way at the base of slopes greater than 5% where the base of the slope is less than 50 feet from the wetland, or as needed to prevent sediment transport into the wetland. In some areas, with the approval of the EI, an earthen berm may be suitable as a sediment barrier adjacent to the wetland.
10. Restore segregated topsoil to its original position after backfilling is complete. When required, additional fill material imported from off the ROW must be approved by the EI.
11. Preconstruction wetland contours and flow regimes will be restored to the extent practical.

#### 6.4.1 Push-pull Technique

The “push-pull” or “float” or “drag section” method may be utilized during wetland crossings if conditions are suitable at the time of construction. Sufficient, naturally present groundwater volumes that fill the excavated trench are required to facilitate this installation method. This method may be used to install the pipeline if the wetland to be crossed contains standing water or saturated and/or unstable soils.

- Trenching equipment will excavate a trench across the wetland, either using low-ground-weight equipment or working on timber matting.
- While the trench is being excavated, the pipeline crossing sections will be assembled and welded together in uplands.
- Prefabricated pipeline crossing sections will then be pushed or pulled into the trench; floated across the wetland and released into the trench if the trench is filled with water; or, carried into position with sideboom tractors supported on equipment mats.
- The excavating equipment will “walk through” the wetland by carrying timber mats and repositioning the mats as it operates from one mat to the next through the wetland during trenching, backfilling, and cleanup activities.

#### 6.5 Wetland Cleanup and Restoration

1. Restore pre-construction wetland contours to maintain the wetland hydrology.
2. Revegetate the ROW with annual ryegrass at 40 lbs/acre PLS or with the recommended Wetland Seed Mix in Appendix C or project-specific seed mix where applicable, unless standing water is present or unless prohibited by state or land management agency.
3. **Do not use lime, mulch or fertilizer in wetland areas** unless required in writing by the appropriate federal or state agency, as identified in the Clearance Package/Permit Book.

4. In the event that final cleanup is deferred more than 20 days after the trench is backfilled, all slopes adjacent to wetlands shall be mulched with 3 tons/acre of straw for a minimum of 100 feet on each side of the crossing.
5. Remove all project-related material used to support equipment on the construction ROW, including timber riprap and prefabricated equipment mats, upon completion of construction.
6. Develop specific procedures in coordination with the appropriate federal or state agency, where necessary, to prevent the invasion or spread of invasive vegetation (such as purple loosestrife and phragmites).
7. Ensure that all disturbed areas permanently revegetate in accordance with Section 8.1.
8. Remove temporary sediment barriers located at the boundary between wetland and adjacent upland areas after upland revegetation and stabilization of adjacent upland areas are successful as specified in Section 8.1.

## 7. SPILL PREVENTION & RESPONSE

### 7.1 SPCC / PPC Plan

The Company and Contractor shall adhere to the SPCC/PPC Plan at all times. This plan has been prepared to meet the requirements of several federal regulations and guidelines: the FERC's Plan and Procedures; Oil Pollution Act; Federal Water Pollution Control Act; Comprehensive Environmental Response, Compensation and Liability Act of 1980; the Resource Conservation and Recovery Act; Toxic Substances Control Act; and, the Clean Water Act.

The purpose of the SPCC/PPC Plan is to reduce the probability and risk of a potential spill or release of oil or hazardous materials during construction-related activities. The objectives of this plan are to identify and address:

- The type and quantity of material handled, stored, or used on site during construction;
- Measures to be taken for spill preparedness and prevention;
- Emergency response procedures;
- Spill incident reporting/notification procedures; and
- Local emergency response team arrangements.

### 7.2 Spill Prevention Measures

Structure operations in a manner that reduce the risk of spills or the accidental exposure of fuels or hazardous materials to waterbodies or wetlands. At a minimum,

1. All employees handling fuels and other hazardous materials are to be properly trained.
2. All equipment shall be in good operating order and inspected on a regular basis.
3. Fuel trucks transporting fuel to on-site equipment should travel only on approved access roads.
4. All equipment is to be parked overnight and/or fueled at least 100 feet from any wetland or waterbody. These activities can occur closer only if the EI determines that there is no reasonable alternative, and appropriate steps have been taken (including secondary containment structures) to prevent spills and provide for prompt cleanup in the event of a spill.
5. Do not store hazardous materials, including chemicals, fuels, and lubricating oils within 100 feet of a wetland, waterbody or designated municipal watershed area, unless the location is designated for such use by an appropriate governmental authority. This applies to storage of these materials and does not apply to normal operation or use of equipment in these areas. If the 100-foot setback cannot be met, this activity can be performed within the 100-foot setback, with EI approval, if done in accordance with the SPCC/PPC Plan.
6. Do not perform fondu or concrete coating activities within 100 feet of any wetland or waterbody boundary, unless the location is an existing industrial site designated for such use. If the 100-foot setback cannot be met, these activities can be performed within the 100-foot setback, if the EI

determines that there is no reasonable alternative and appropriate steps have been taken (including secondary containment structures) to prevent spills and provide for prompt cleanup in the event of a spill.

7. Pumps operating within 100 feet of a waterbody or wetland boundary shall utilize appropriate secondary containment systems to prevent spills; and
8. Bulk storage of hazardous materials, including chemicals, fuels, and lubricating oils have appropriate secondary containment systems to prevent spills.

### **7.3 Spill Cleanup & Response**

Structure operations in a manner that provides for the prompt and effective cleanup of spills of fuel and other hazardous materials. At a minimum,

1. Ensure that each construction crew (including cleanup crews) has on hand sufficient supplies of absorbent and barrier materials to allow the rapid containment and recovery of spilled materials and knows the procedure for reporting spills and unanticipated discoveries of contamination;
2. Ensure that each construction crew has on hand sufficient tools and material to stop leaks; and,
3. Know the contact names and telephone numbers for all local, state, and federal agencies (including, if necessary, the U. S. Coast Guard and the National Response Center) that must be notified of a spill; and follow the requirements of those agencies in cleaning up the spill, in excavating and disposing of soils or other materials contaminated by a spill, and in collecting and disposing of waste generated during spill cleanup.

## 8. POST-CONSTRUCTION ACTIVITIES

### 8.1 POST-CONSTRUCTION MONITORING

Projects conducted under the blanket certificate or a project-specific Section 7 Order, shall meet the monitoring requirements set forth in this section. Company personnel shall perform the following:

1. Establish and implement a program to monitor the success of restoration upon completion of construction and restoration activities.
2. Conduct follow-up inspections of all disturbed upland areas as necessary, to determine the success of revegetation and address landowner concerns. At a minimum, conduct inspections after the first and second growing seasons.
3. In nonagricultural upland areas, revegetation shall be considered successful if the vegetative cover is sufficient to prevent the erosion of soils on the disturbed ROW and density and cover are similar to that in adjacent undisturbed area. Sufficient coverage in upland areas is defined when vegetation has a uniform 70 percent vegetative coverage.
4. In agricultural areas, revegetation shall be considered successful when upon visual survey, growth and vigor are similar to adjacent undisturbed portions of the same field, unless the easement agreement specifies otherwise.
5. In wetlands, monitor and record the success of revegetation annually, until wetland revegetation is successful:
  - a. Wetland revegetation will be considered successful when the affected wetland satisfies the current federal definition for a wetland (i.e. soils, hydrology, and vegetation);
  - b. Vegetation should be at least 80 percent of either the cover documented for the wetland prior to construction, or at least 80 percent of the cover in adjacent wetland areas that were not disturbed by construction;
  - c. If natural rather than active revegetation was used, the plant species composition must be consistent with early successional wetland plant communities in the affected ecoregion;
  - d. Invasive species and noxious weeds should be absent unless they are abundant in adjacent areas that were not disturbed by construction; and,
  - e. For any wetland where revegetation is not successful at the end of 3 years after construction, the Company shall develop and implement (in consultation with a professional wetland ecologist) a remedial plan to actively revegetate the wetland.
6. Inspect all remaining temporary erosion and sediment controls during routine patrols to ensure proper functioning. Any deficiencies found will be reported and corrected as needed. Once the area has revegetated and stabilized, the erosion controls will be removed.
7. Revegetation efforts (such as fertilizing or reseeding) will continue until revegetation is successful.

8. Restoration shall be considered successful if the ROW surface condition is similar to adjacent undisturbed lands, construction debris is removed (unless otherwise approved by the land owner or land managing agency), revegetation is successful, and proper drainage has been restored.
9. Monitor and correct problems with drainage and irrigation systems resulting from pipeline construction in agricultural areas until restoration is successful.
10. Make efforts to control unauthorized off-road vehicle use, in cooperation with the landowner, throughout the life of the project. Maintain signs, gates, and vehicle trails as necessary.

## **8.2 POST-CONSTRUCTION MAINTENANCE**

Routine maintenance of the ROW is required to allow continued access for routine pipeline patrols, maintaining access in the event of emergency repairs, and visibility during aerial patrols. Where the newly established pipeline ROW is located on other existing ROWs not affiliated with the Company, the easement holder or owner will continue to maintain their ROWs using procedures specified in their vegetative management programs.

Projects conducted under this E&SCP and subject to the FERC Plan and Procedures, shall meet the maintenance requirements set forth in this section. The following requirements restrict the amount of vegetation maintenance that can occur within new ROW.

### **8.2.1 Uplands**

In upland areas, maintenance of the ROW will involve clearing the entire ROW of woody vegetation.

1. Routine vegetation mowing or clearing over the full width of the permanent ROW in uplands shall be conducted no more frequently than once every 3 years. However, to facilitate periodic corrosion and leak surveys, a 10-foot wide corridor centered on the pipeline may be cleared at a frequency necessary to maintain the 10-foot corridor in an herbaceous state.
2. Routine vegetation mowing or clearing shall not occur between April 15 and August 1 of any year unless specifically approved in writing by the responsible land management agency of the U.S. Fish and Wildlife Service.

### **8.2.2 Waterbodies and Wetlands**

1. Do not conduct routine vegetation mowing or clearing over the full width of the permanent ROW in wetlands or riparian areas.
  - a. Limit routine vegetation mowing or clearing practices adjacent to waterbodies to allow a riparian strip that measures 25 feet back from the waterbody's mean high water mark. This riparian strip will be allowed to permanently revegetate with native plant species across the entire construction ROW.
  - b. To facilitate periodic corrosion and leak surveys within wetlands and the 25-foot-wide riparian strip adjacent to waterbodies, a corridor up to 10 feet wide centered on the

pipeline may be cleared at a frequency necessary to maintain the 10-foot corridor in an herbaceous state.

- c. Trees located within 15 feet of the pipeline that have roots that could compromise the integrity of the pipeline coating may be cut and removed from the permanent ROW.
2. Do not conduct any routine vegetation mowing or clearing in riparian areas or wetlands that are between HDD entry and exit points.
3. Herbicides or pesticides shall not be used in or within 100 feet of a wetland or waterbody, except as specified by the federal or state agency.
4. Time of year restrictions apply to routine mowing as well as selective clearing of trees within riparian or wetland areas. These activities are prohibited between April 15 – August 1 of any year.

### 8.3 REPORTING

The Company shall maintain records that identify by milepost:

1. Method of application, application rate, and type of fertilizer, pH modifying agent, seed, and mulch used;
2. Acreage treated;
3. Dates of backfilling and seeding;
4. The location of any subsurface drainage repairs or improvements made during restoration;
5. Names of landowners requesting special seeding treatment and a description of the follow-up actions; and
6. Any problem areas and how they were addressed.

The Contractor is responsible for providing the EI with the information and documentation on applications, rates, and types of fertilizer, pH modifying agents, seed and mulch that are used during a project.

For the FERC-authorized projects, other than projects conducted under the blanket certificate, the Company will file quarterly activity reports documenting problems, including those identified by the landowner, and corrective actions taken for at least 2 years following construction.

A wetland revegetation monitoring report identifying the status of the wetland revegetation efforts will be filed at the end of 3 years following construction, and annually thereafter documenting progress within the wetland until revegetation is successful. The requirements to file wetland restoration reports with FERC does not apply to projects authorized under the blanket certificate (i.e. automatic and prior notice) or advanced notice provisions in the FERC regulations.

## APPENDIX A

---

### E&SCP FIGURES

Q:\S-U\SPE\2013-200.00\AutoCAD\Final\es0000.dwg

Wayne Siora  
6/9/2014 4:44 PM

I.G. ES0000.DWG

FIGURE NUMBER	STANDARD NUMBER	DRAWING TITLE
<b>CONSTRUCTION WORKAREAS (CW)</b>		
CW-1	ES-0001	TYPICAL TRENCH DETAIL
CW-2	ES-0002	RIGHT-OF-WAY TOPSOIL SEGREGATION TECHNIQUES
CW-3	ES-0003	TYPICAL CONSTRUCTION WIDTHS ACQUIRING NEW PERMANENT RIGHT-OF-WAY
CW-4	ES-0004	TYPICAL CONSTRUCTION WIDTHS NOT ACQUIRING NEW PERMANENT RIGHT-OF-WAY (SINGLE LINE SYSTEM)
CW-5	ES-0005	TYPICAL CONSTRUCTION WIDTHS NOT ACQUIRING NEW PERMANENT RIGHT-OF-WAY (MULTIPLE LINE SYSTEM)
<b>ACCESS ROADS &amp; ROAD CROSSINGS (RD)</b>		
RD-1	ES-0006	ACCESS ROAD CROSS SECTION
RD-2	ES-0007	ROCK ACCESS PAD
RD-3	ES-0008	TYPICAL TEMPORARY ACCESS ROAD THROUGH WETLANDS
RD-4	ES-0009	TYPICAL PAVED ROAD CROSSING CONTROL MEASURES (OPEN CUT)
RD-5	ES-0010	TYPICAL PAVED ROAD CROSSING CONTROL MEASURES (BORED)
<b>EROSION CONTROLS (EC)</b>		
EC-1	ES-0011	SILT FENCE DETAIL
EC-2	ES-0012	STRAW BALE DETAIL
EC-3	ES-0013	STRAW BALE CHECK DAM IN A DRAINAGEWAY
EC-4	ES-0014	ROCK-LINED DRAINAGE SWALE
EC-5	ES-0015	STORM DRAIN INLET PROTECTION
EC-6	ES-0016	TEMPORARY TRENCH PLUG OPTIONS
EC-7	ES-0017	TEMPORARY SLOPE BREAKERS
EC-8	ES-0018	PERMANENT SLOPE BREAKERS
EC-9	ES-0019	CHEVRON SLOPE BREAKER
EC-10	ES-0020	TRENCH BREAKER DETAIL (SACK)
EC-11	ES-0021	TRENCH BREAKER DETAIL (FOAM)
EC-12	ES-0022	PERMANENT TRENCH BREAKER OPTIONS
EC-13	ES-0023	EROSION CONTROL FABRIC INSTALLATION
EC-14	ES-0024	TYPICAL EROSION CONTROL BLANKETS ON SLOPES
<b>WATER DISCHARGES (WD)</b>		
WD-1	ES-0025	FILTER BAG
WD-2	ES-0026	DISCHARGE STRUCTURE FOR HYDROSTATIC TEST WATER
WD-3	ES-0027	OPTIONS FOR SMALL WATER DISCHARGES
WD-4	ES-0028	DISCHARGE OF HYDROSTATIC TEST WATER TO A SURFACE WATER
<b>BRIDGES (BR)</b>		
BR-1	ES-0029	TEMPORARY EQUIPMENT BRIDGE (EQUIPMENT PADS WITH OR WITHOUT CULVERTS)
BR-2	ES-0030	TEMPORARY EQUIPMENT BRIDGE (CRUSHED STONE WITH CULVERTS)
BR-3	ES-0031	TEMPORARY EQUIPMENT BRIDGE (FLEXI-FLOAT OR PORTABLE BRIDGE)
<b>WATERBODY AND WETLAND CROSSINGS (WC)</b>		
WC-1	ES-0032	TYPICAL STANDARD WETLAND CROSSING
WC-2	ES-0033	TYPICAL WET WATERBODY CROSSING
WC-3	ES-0034	TYPICAL FLUME WATERBODY CROSSING
WC-4	ES-0035	TYPICAL DAM-AND-PUMP WATERBODY CROSSING
WC-5	ES-0036	TYPICAL EROSION CONTROL BLANKETS ON STREAMBANKS
WC-6	ES-0037	TYPICAL RIP-RAP PLACEMENT
<b>SPECIAL USE / AGRICULTURAL AREAS (SU)</b>		
SU-1	ES-0038	DRAIN TILE REPAIR PROCEDURE

**INDEX OF FIGURES**

**APPENDIX A**

DWG.	ES-0000	REV.
------	---------	------

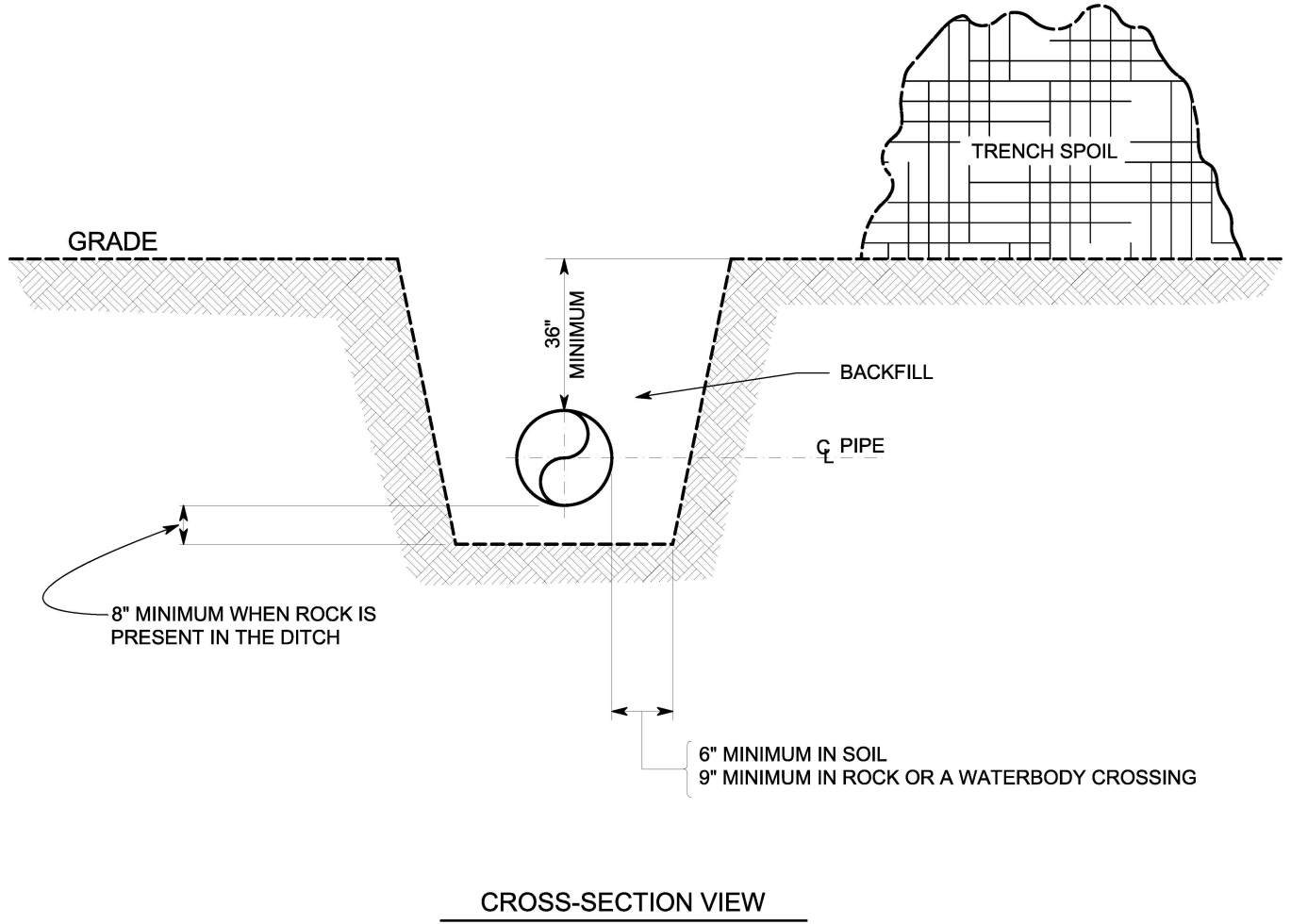

- NOTES:
1. ALL PRECONSTRUCTION CONTOURS WILL BE RE-ESTABLISHED UPON COMPLETION OF PIPE INSTALLATION. EXCEPT IN WETLANDS, A CROWN MAY BE LEFT TO ACCOUNT FOR DITCH SETTLING, AS DIRECTED BY THE ENVIRONMENTAL INSPECTOR.
  2. IN COLD WATER FISHERY STREAMS, THE TOP 12" OF THE TRENCH WILL BE BACKFILLED WITH CLEAN GRAVEL OR NATIVE COBBLES UNLESS OTHERWISE SPECIFIED BY THE PERMITTING AGENCY.

TYPICAL TRENCH DETAIL

FIGURE CW-1

DWG.	ES-0001	REV.
------	---------	------

Q:\S-U\SPE\2013-200.00\AutoCAD\Final\es0002.dwg

Wayne Siorra  
6/9/2014 3:59 PM

I.G. ES0002.DWG

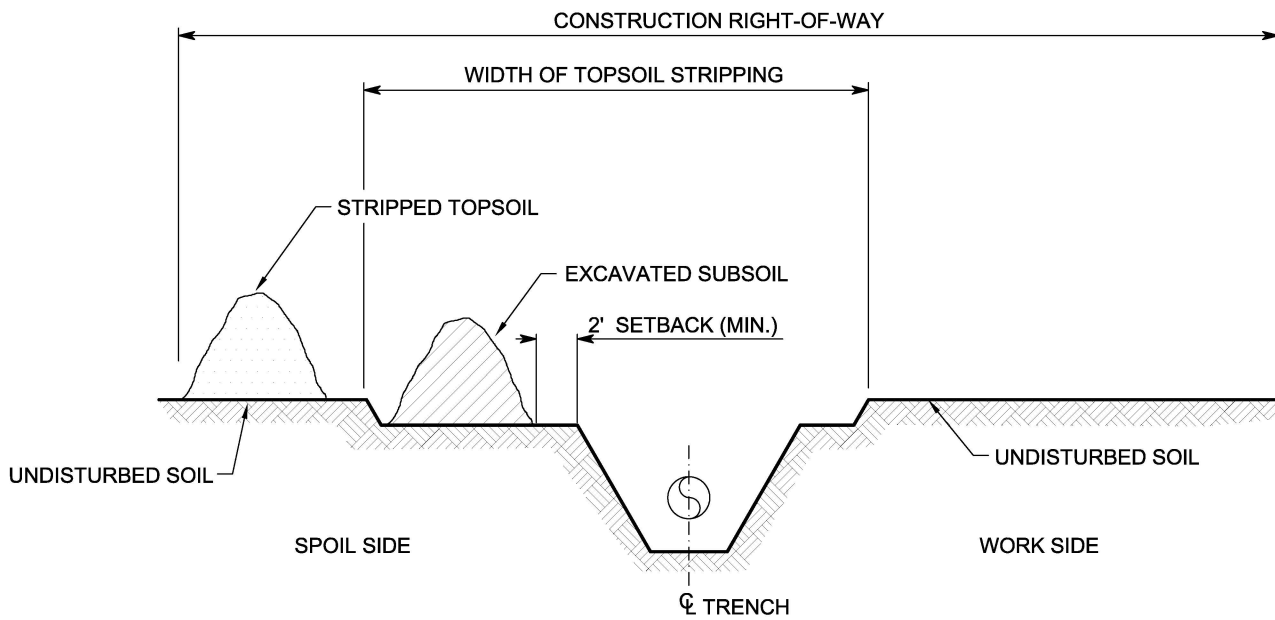

DITCH PLUS SPOILSIDE TOPSOIL SEGREGATION

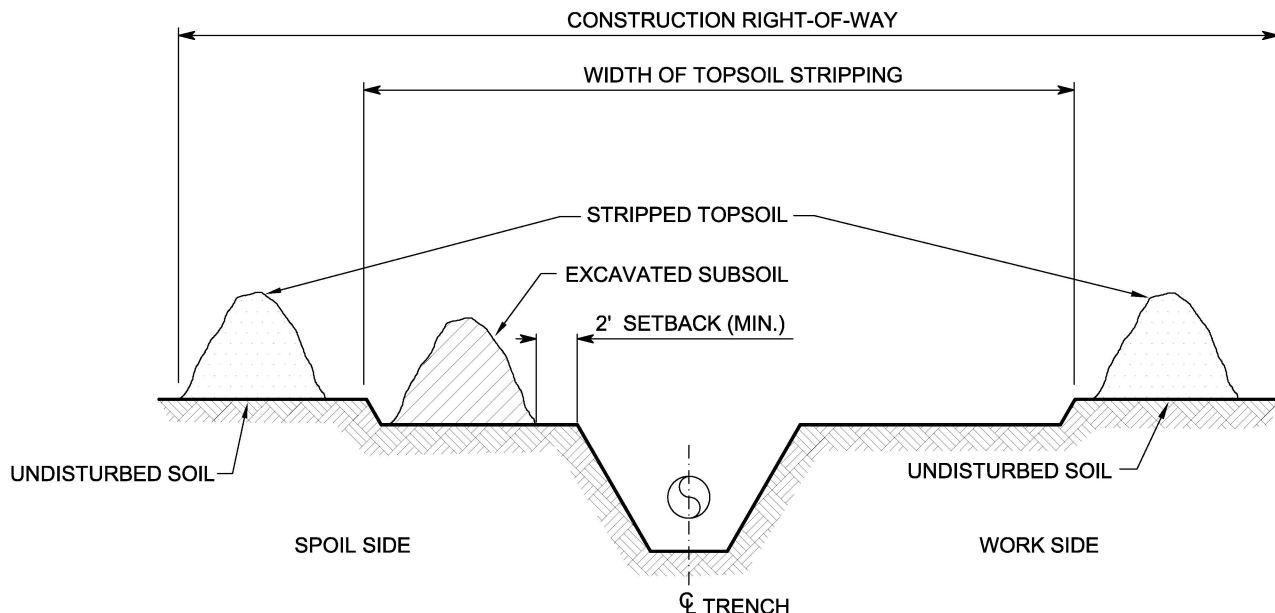

FULL RIGHT-OF-WAY TOPSOIL STRIPPING

NOTES:

1. TOPSOIL MAY BE STORED IN LOCATIONS AS SHOWN ABOVE OR AT OTHER COMPANY APPROVED LOCATIONS WITHIN THE CONSTRUCTION R.O.W.
2. LEAVE GAPS IN SPOIL PILES FOR WATER RUN-OFF.
3. MAINTAIN SEPARATION OF SALVAGED TOPSOIL AND SUBSOIL THROUGHOUT ALL CONSTRUCTION ACTIVITIES.
4. STABILIZE TOPSOIL PILES AND MINIMIZE LOSS DUE TO WATER OR WIND EROSION WITH USE OF SEDIMENT BARRIERS, MULCH, TEMPORARY SEEDING, TACKIFIERS OR FUNCTIONAL EQUIVALENTS, WHERE NECESSARY.

**RIGHT-OF-WAY TOPSOIL SEGREGATION TECHNIQUES**

**FIGURE CW-2**

DWG. ES-0002	REV.
--------------	------

Q:\S-U\SPE\2013-200.00\AutoCAD\Final\es0003.dwg

Wayne Siorra  
5/28/2014 11:44 AM

I.G. ES0003.DWG

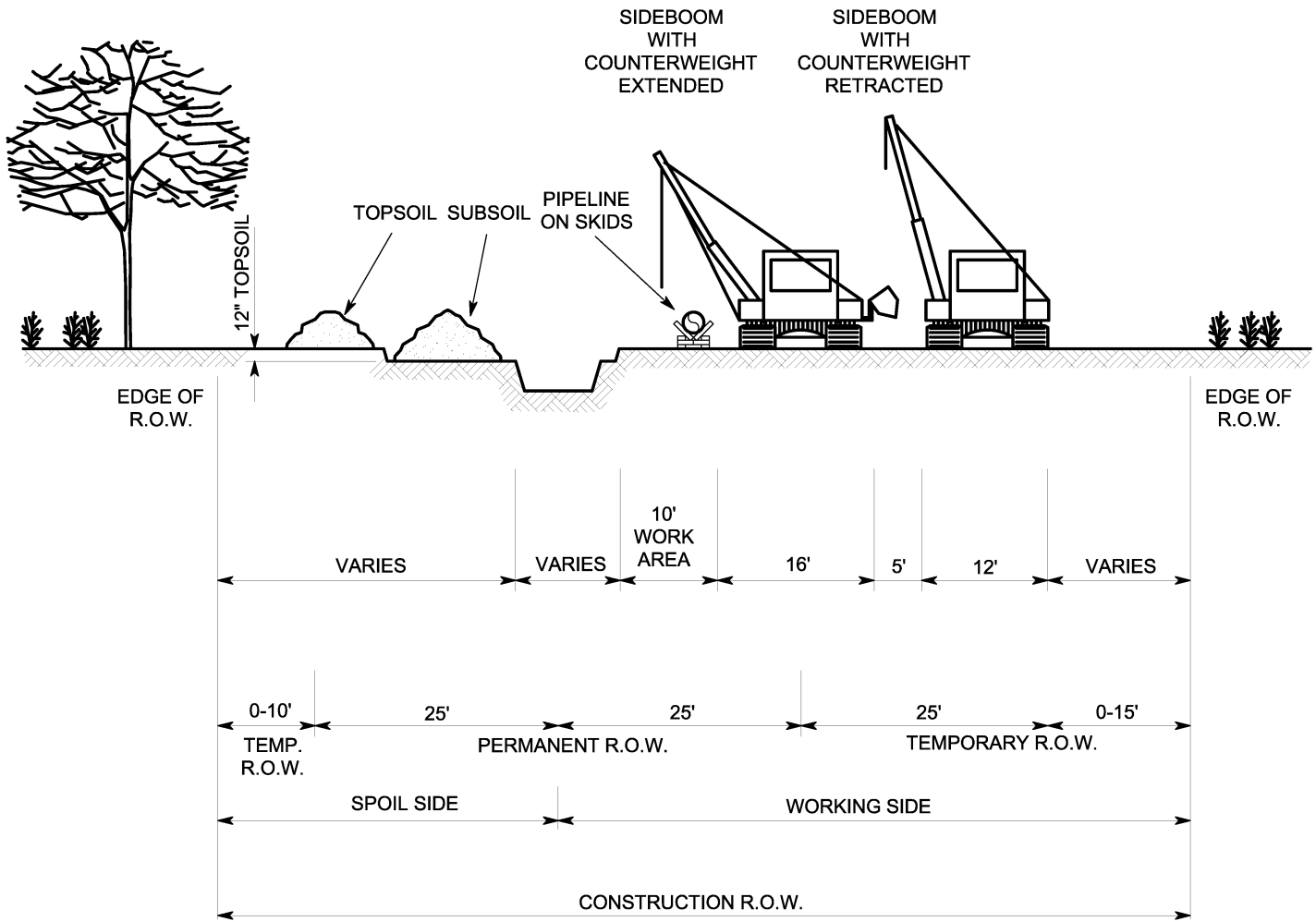

PIPE DIAMETER	SPOIL SIDE (FT.)	WORKING SIDE (FT.)	CONSTRUCTION R.O.W. (FT.)
12" OR LESS	25	50	75
14" - 30"	35	50	85
36" - 42"	35	65	100
WETLANDS	25	50	75

**NOTES:**

- ALTHOUGH THE DIMENSIONS SHOWN ARE TYPICAL, SOME VARIATIONS MAY EXIST DUE TO SITE SPECIFIC CONDITIONS. UNLESS OTHERWISE INDICATED ON THE ALIGNMENT SHEETS, THE MAXIMUM WIDTH OF THE CONSTRUCTION RIGHT-OF-WAY SHALL BE AS SHOWN IN THE TABLE FOR THE APPROPRIATE PIPE DIAMETER.
- TOPSOIL SEGREGATION METHODS WILL BE USED IN ALL RESIDENTIAL AREAS AND WHEN THE CONSTRUCTION ROW IS WIDER THAN 30 FEET IN CULTIVATED OR ROTATED AGRICULTURAL LANDS, MANAGED PASTURES, HAYFIELDS, AND OTHER AREAS AT THE LANDOWNER'S OR LAND MANAGEMENT AGENCY'S REQUEST. FOR WETLANDS, SEGREGATE THE TOP 12 INCHES OF TOPSOIL WITHIN THE DITCH LINE, EXCEPT IN AREAS WHERE STANDING WATER IS PRESENT OR SOILS ARE SATURATED.

**TYPICAL CONSTRUCTION WIDTHS ACQUIRING  
NEW PERMANENT RIGHT-OF-WAY**

**FIGURE CW-3**

DWG. **ES-0003**

REV.

Q:\S-U\SPE\2013-200.00\AutoCAD\Final\es0004.dwg

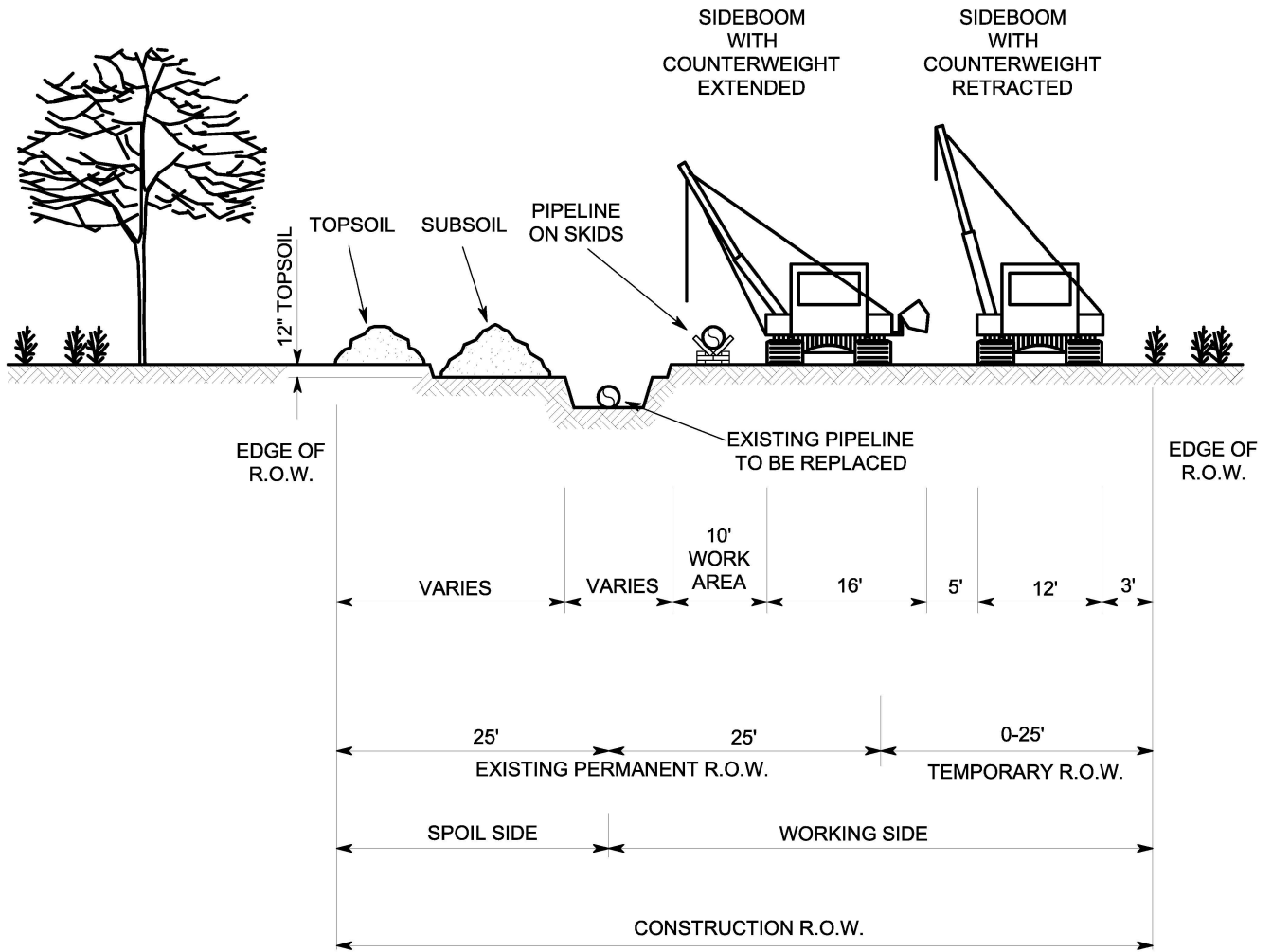

PIPE DIAMETER	SPOIL SIDE (FT.)	WORKING SIDE (FT.)	CONSTRUCTION R.O.W. (FT.)
12" OR LESS	25	25	50
14" - 30"	25	50	75
36" - 42"	25	50	75
WETLANDS	25	50	75

**NOTES:**

- ALTHOUGH THE DIMENSIONS SHOWN ARE TYPICAL, SOME VARIATIONS MAY EXIST DUE TO SITE SPECIFIC CONDITIONS. UNLESS OTHERWISE INDICATED ON THE ALIGNMENT SHEETS, THE MAXIMUM WIDTH OF THE CONSTRUCTION RIGHT-OF-WAY SHALL BE AS SHOWN IN THE TABLE FOR THE APPROPRIATE PIPE DIAMETER.
- TOPSOIL SEGREGATION METHODS WILL BE USED IN ALL RESIDENTIAL AREAS AND WHEN THE CONSTRUCTION ROW IS WIDER THAN 30 FEET IN CULTIVATED OR ROTATED AGRICULTURAL LANDS, MANAGED PASTURES, HAYFIELDS, AND OTHER AREAS AT THE LANDOWNER'S OR LAND MANAGEMENT AGENCY'S REQUEST. FOR WETLANDS, SEGREGATE THE TOP 12 INCHES OF TOPSOIL WITHIN THE DITCH LINE, EXCEPT IN AREAS WHERE STANDING WATER IS PRESENT OR SOILS ARE SATURATED.
- IF THE WORKING SIDE MUST BE GREATER THAN THE VALUES SHOWN IN THE TABLE, COMPANY MUST REQUEST APPROVAL FROM THE F.E.R.C.

Wayne Sicora  
5/28/2014 11:46 AM

I.G. ES0004.DWG

TYPICAL CONSTRUCTION WIDTHS NOT ACQUIRING NEW PERMANENT RIGHT-OF-WAY (SINGLE LINE SYSTEM)

FIGURE CW-4

DWG. ES-0004

REV.

Q:\S-U\SPE\2013-200.00\AutoCAD\Final\es0005.dwg

Wayne Sicora  
5/28/2014 11:47 AM

I.G. ES0005.DWG

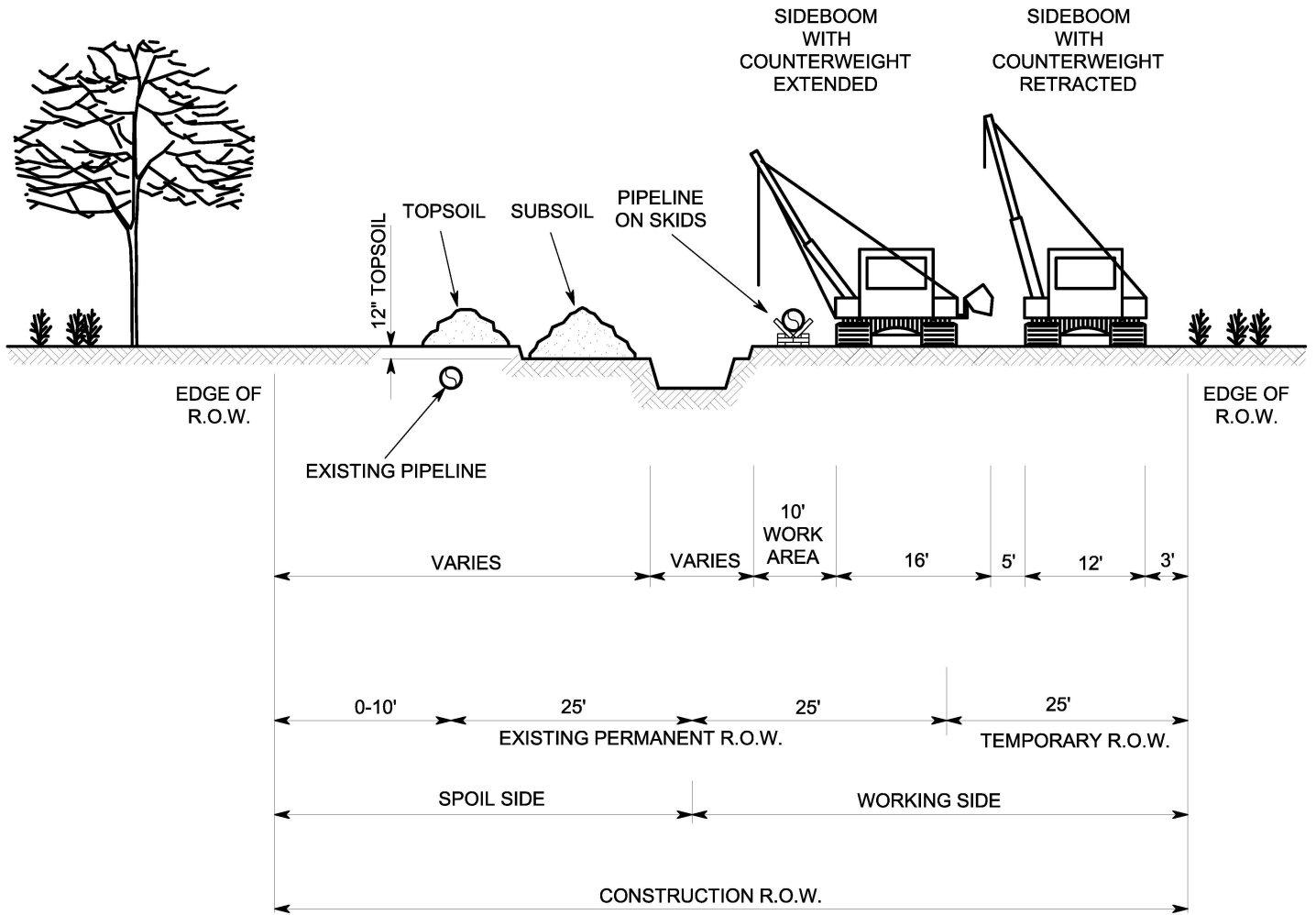

PIPE DIAMETER	SPOIL SIDE (FT.)	WORKING SIDE (FT.)	CONSTRUCTION R.O.W. (FT.)
12" OR LESS	25	50	75
14" - 30"	35	50	85
36" - 42"	35	50	85
WETLANDS	25	50	75

**NOTES:**

- ALTHOUGH THE DIMENSIONS SHOWN ARE TYPICAL, SOME VARIATIONS MAY EXIST DUE TO SITE SPECIFIC CONDITIONS. UNLESS OTHERWISE INDICATED ON THE ALIGNMENT SHEETS, THE MAXIMUM WIDTH OF THE CONSTRUCTION RIGHT-OF-WAY SHALL BE AS SHOWN IN THE TABLE FOR THE APPROPRIATE PIPE DIAMETER.
- TOPSOIL SEGREGATION METHODS WILL BE USED IN ALL RESIDENTIAL AREAS AND WHEN THE CONSTRUCTION ROW IS WIDER THAN 30 FEET IN CULTIVATED OR ROTATED AGRICULTURAL LANDS, MANAGED PASTURES, HAYFIELDS, AND OTHER AREAS AT THE LANDOWNER'S OR LAND MANAGEMENT AGENCY'S REQUEST. FOR WETLANDS, SEGREGATE THE TOP 12 INCHES OF TOPSOIL WITHIN THE DITCH LINE, EXCEPT IN AREAS WHERE STANDING WATER IS PRESENT OR SOILS ARE SATURATED.
- IF THE WORKING SIDE MUST BE GREATER THAN 50 FEET (i.e. TEMPORARY WORKSPACE IS GREATER THAN 25 FEET), COMPANY MUST REQUEST APPROVAL FROM THE F.E.R.C.

TYPICAL CONSTRUCTION WIDTHS NOT ACQUIRING NEW PERMANENT RIGHT-OF-WAY (MULTIPLE LINE SYSTEM)

FIGURE CW-5

DWG. ES-0005

REV.

Q:\S-U\SPE\2013-200.00\AutoCAD\Final\es0006.dwg

Wayne Sicora  
5/28/2014 12:43 PM

I.G. ES0006.DWG

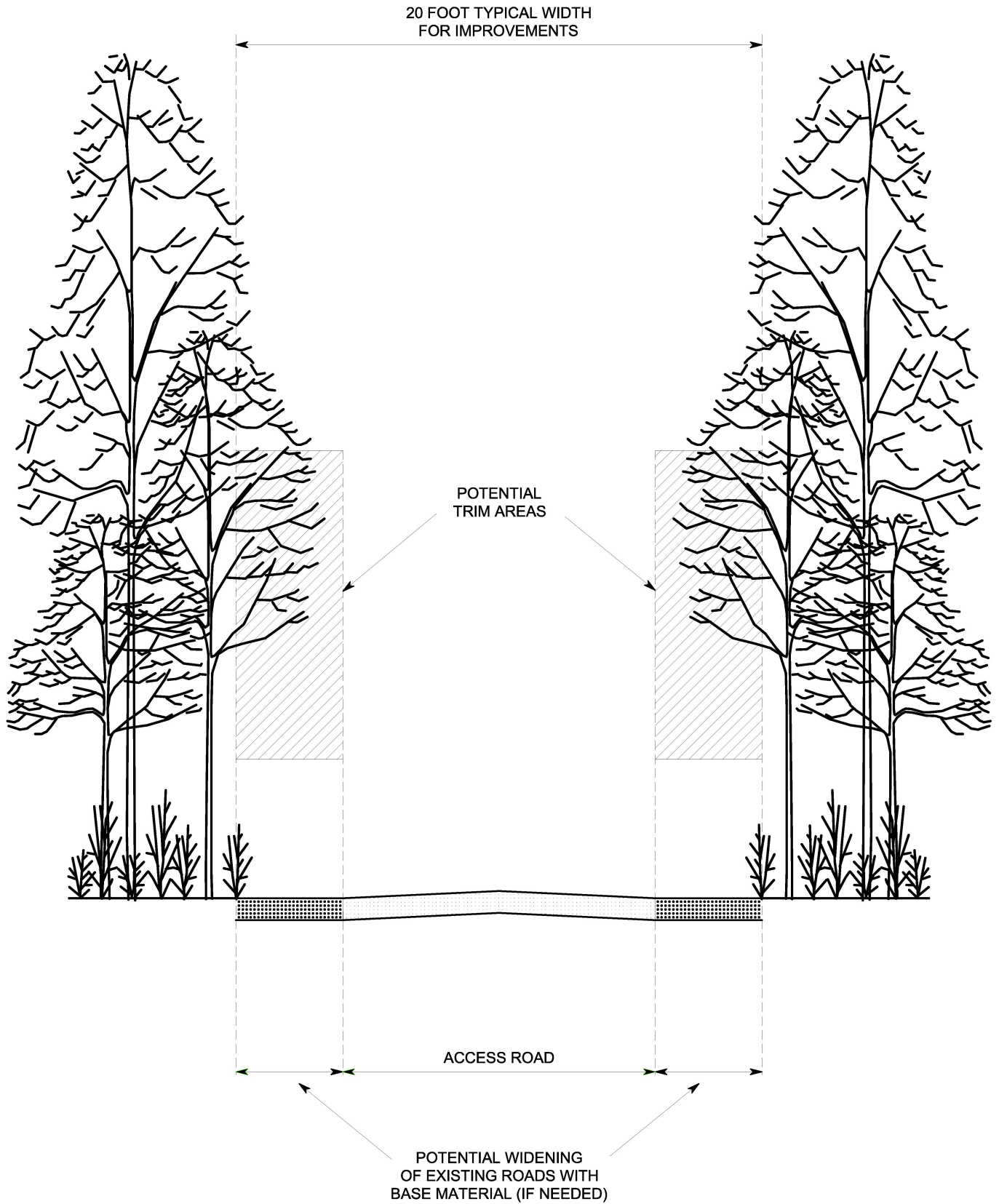

ACCESS ROAD CROSS SECTION

FIGURE RD-1

DWG. ES-0006

REV.

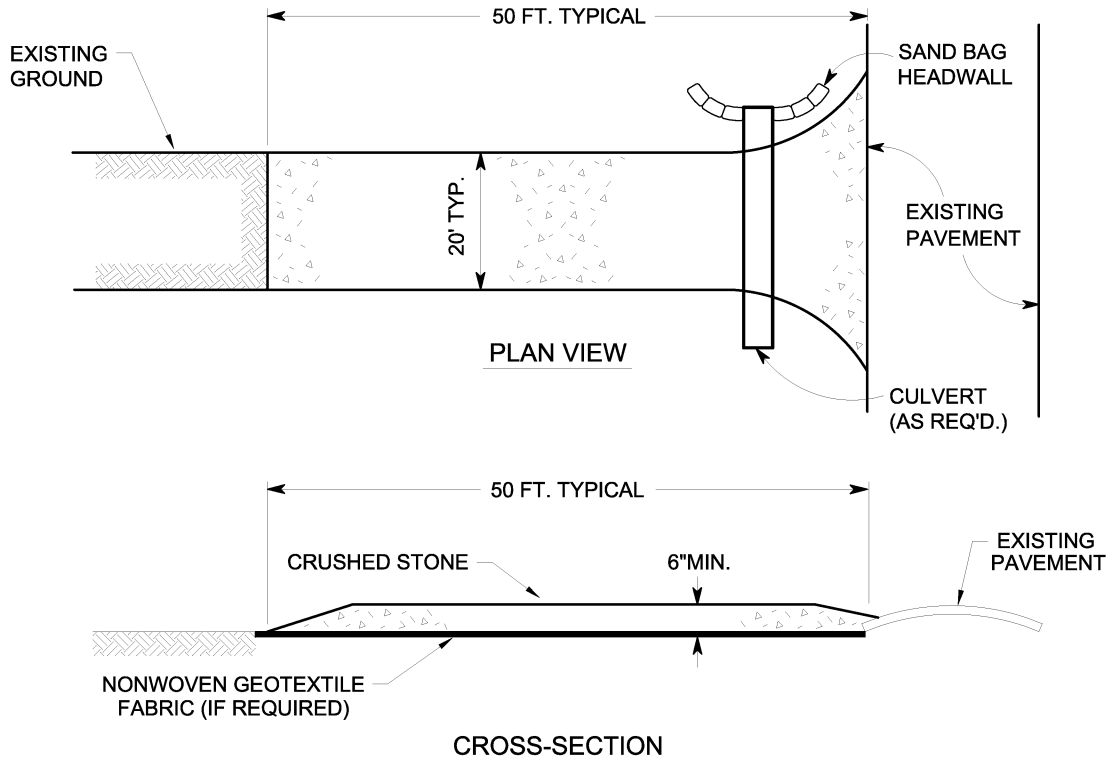

**CONSTRUCTION SPECIFICATIONS:**

1. STONE SIZE = 4" - 6" AVG. DIAMETER
2. ALL STONE MUST BE PLACED ON NON-WOVEN GEOTEXTILE FABRIC IF USED IN RESIDENTIAL OR AGRICULTURAL AREAS.
3. LENGTH = FIFTY (50) FOOT TYPICAL (IF SITE CONDITIONS ALLOW)
4. WIDTH = TWENTY (20) FOOT TYPICAL.
5. THICKNESS = SIX (6) INCHES MINIMUM.
6. ALL SURFACE WATER FLOWING OR DIVERTED TOWARD CONSTRUCTION ENTRANCES SHALL BE PIPED ACROSS THE ENTRANCE. IF PIPING IS IMPRACTICAL, A DRIVEABLE BERM OR OTHER TEMPORARY EROSION CONTROL DEVICE CAN BE USED.
7. THE ENTRANCE SHALL BE PERIODICALLY INSPECTED AND MAINTAINED IN A CONDITION THAT MINIMIZES TRACKING OR FLOWING OF SEDIMENT ONTO ROADWAYS. MAINTENANCE MAY INCLUDE PERIODIC TOP DRESSING WITH ADDITIONAL STONE OR THE REPAIR / CLEANOUT OF ANY MEASURES USED TO TRAP SEDIMENT. ANY SEDIMENT THAT IS SPILLED, DROPPED, WASHED OR TRACKED ONTO ROADWAYS MUST BE REMOVED AS SOON AS PRACTICAL.

**ROCK ACCESS PAD**

**FIGURE RD-2**

DWG. ES-0007

REV.

Q:\S-U\SPE\2013-200.00\AutoCAD\Final\es0008.dwg

Wayne Sicora  
5/28/2014 11:55 AM

I.G. ES0008.DWG

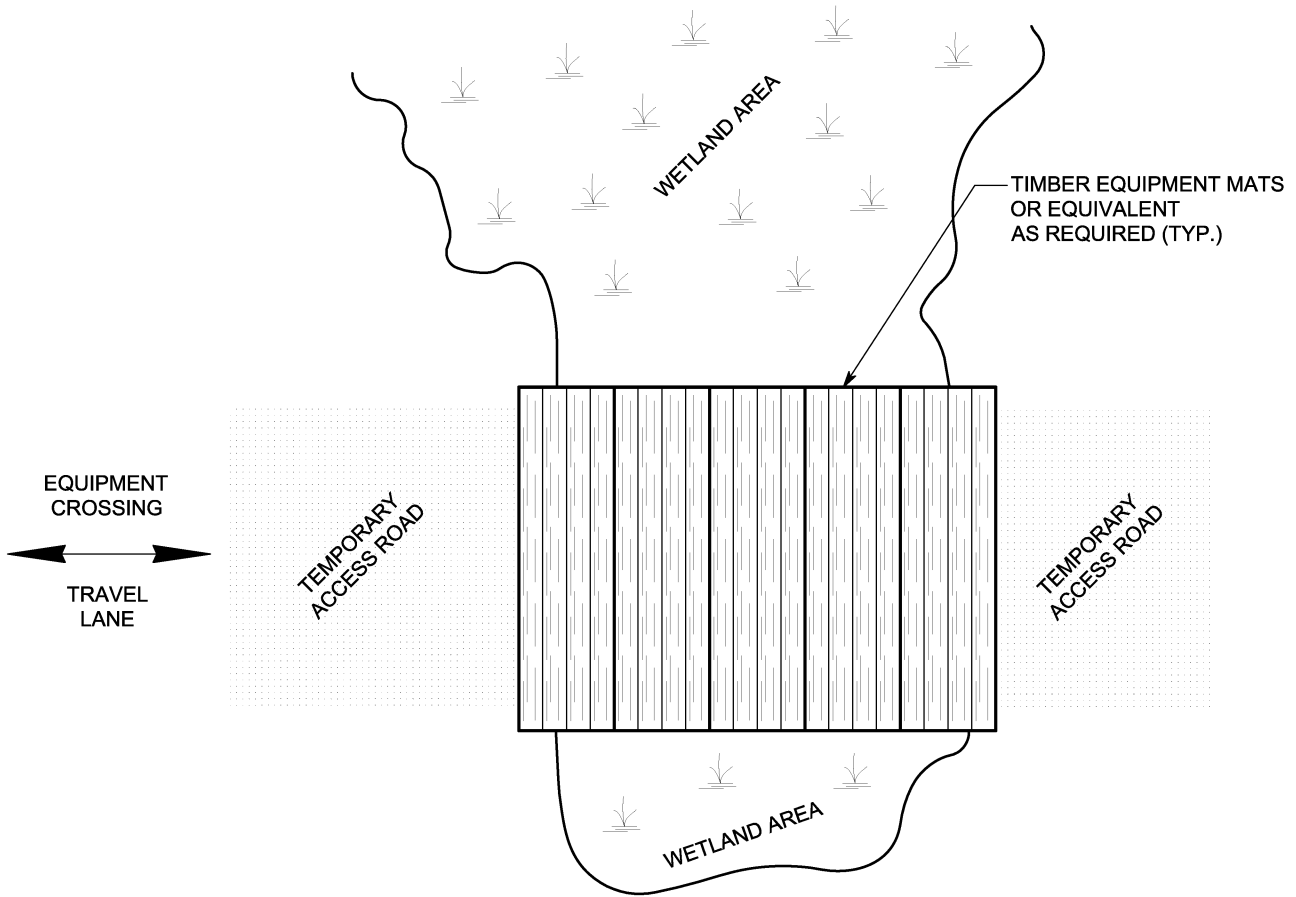

**PLAN VIEW**  
NOT TO SCALE

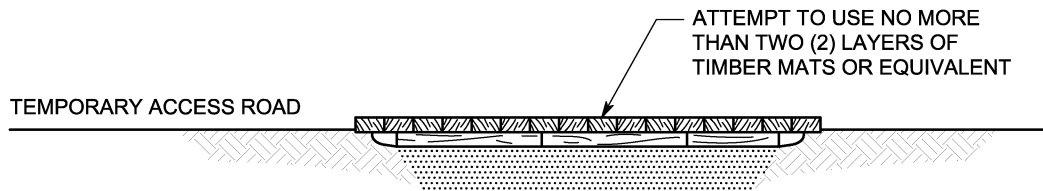

**CROSS-SECTION**  
NOT TO SCALE

**NOTE:**

1. SILT FENCE OR STRAW BALES MAY BE USED, AS NECESSARY, TO PREVENT SEDIMENT FROM MIGRATING OUTSIDE OF ACCESS ROAD LIMITS.

**TYPICAL TEMPORARY ACCESS ROAD THROUGH WETLANDS**

**FIGURE RD-3**

DWG. ES-0008

REV.

Q:\S-U\SPE\2013-200.00\AutoCAD\Final\es0009.dwg

Wayne Siorco  
5/28/2014 11:57 AM

I.G. ES0009.DWG

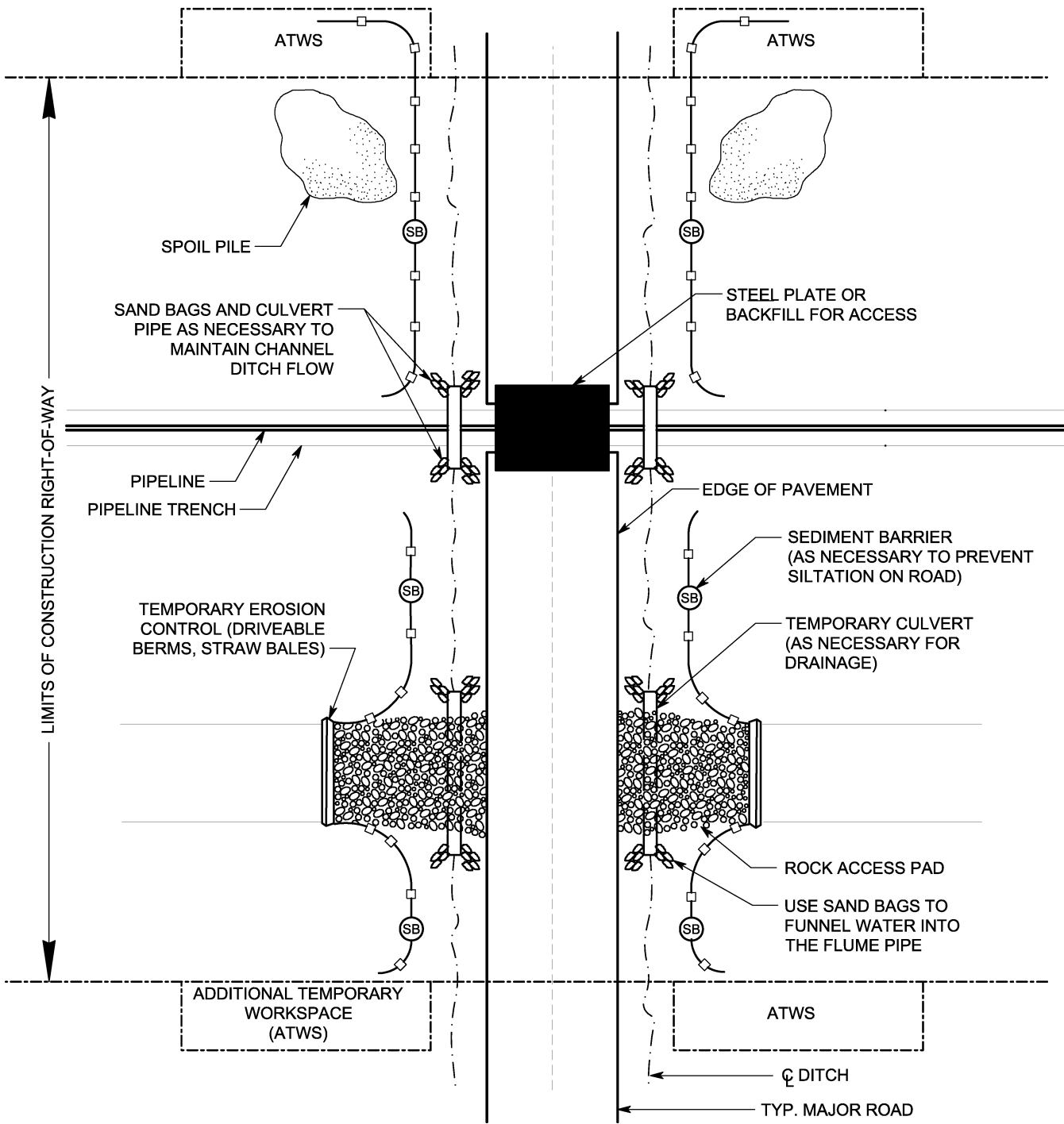

**NOTES:**

1. FIRST LAY SAND BAGS IN DITCH, THEN PLACE END OF CULVERT IN THE MIDDLE OF THE SAND BAGS BEFORE BUILDING HEAD WALLS TO CULVERT.
2. (SB) TEMPORARY SEDIMENT BARRIER OF SILT FENCE AND/OR STRAW BALES, OR OTHER APPROPRIATE MATERIALS.

**TYPICAL PAVED ROAD CROSSING CONTROL MEASURES (OPEN CUT)**

**FIGURE RD-4**

DWG.	ES-0009	REV.
------	---------	------

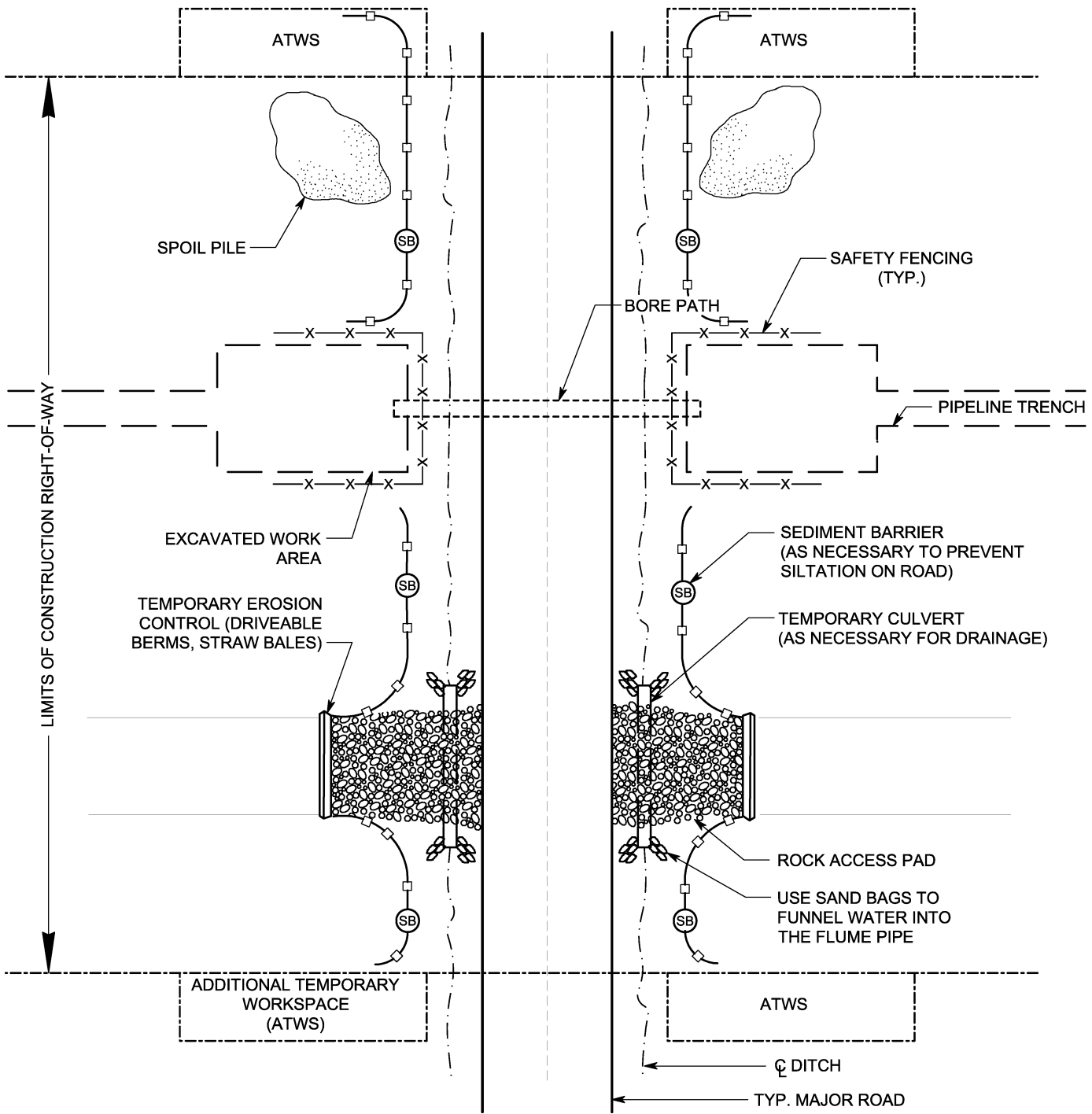

**NOTES:**

1. BORE PIT DIMENSIONS WILL BE DICTATED BY SITE-SPECIFIC CONDITIONS (E.G. SOIL TYPE, WIDTH OF ROAD, DEPTH OF COVER).
2. (SB) TEMPORARY SEDIMENT BARRIER OF SILT FENCE AND/OR STRAW BALES, OR OTHER APPROPRIATE MATERIALS.

**TYPICAL PAVED ROAD CROSSING CONTROL MEASURES (BORED)**

**FIGURE RD-5**

DWG. ES-0010

REV.

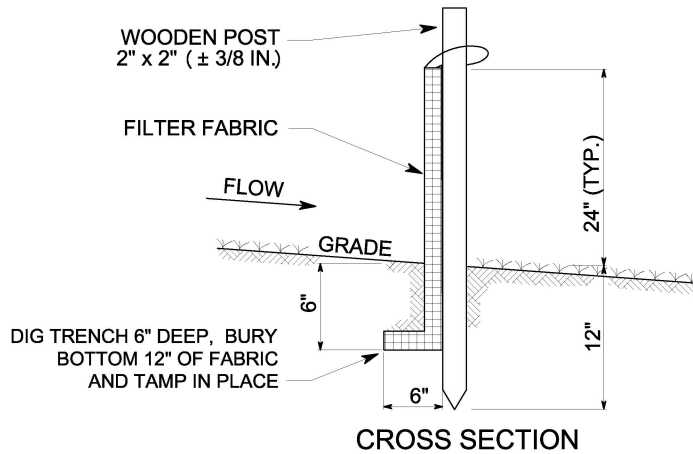
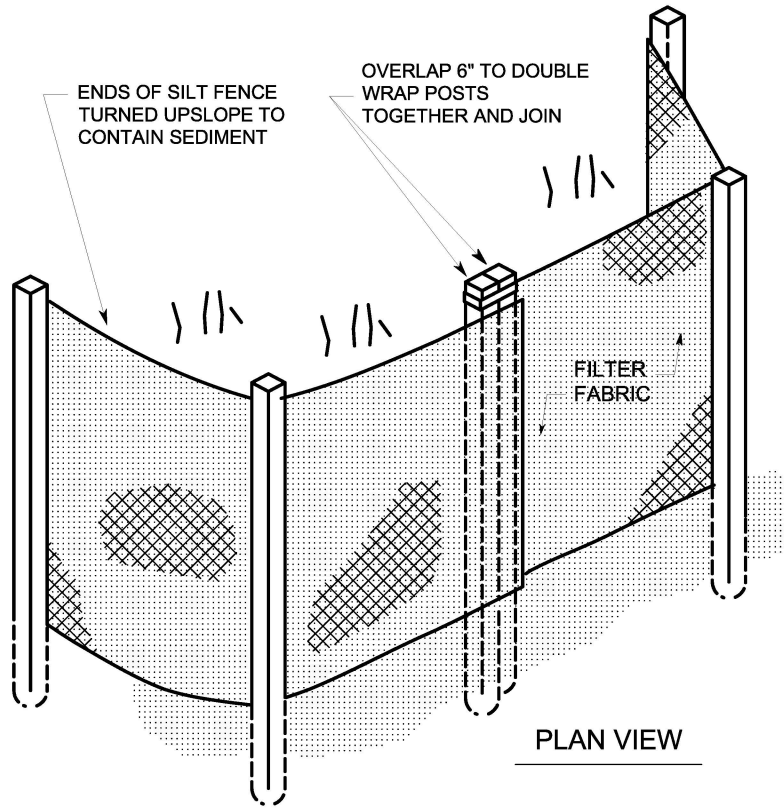

**INSTALLATION REQUIREMENTS:**

- WHEN USING SILT FENCE, PLACE IT:
  - ◆ BETWEEN DISTURBED AREAS AND DOWN-SLOPE ENVIRONMENTAL RESOURCE AREAS
  - ◆ AT THE BASE OF ALL SLOPES NEXT TO WETLANDS, WATERBODIES, AND ROAD CROSSINGS
  - ◆ AT THE INLET AND OUTLET OF OPEN DRAINAGE STRUCTURES
  - ◆ APPROXIMATELY 8 FEET BEYOND THE TOE OF THE SLOPE TO GIVE THE SEDIMENT ROOM TO COLLECT (IF POSSIBLE)
- USE SANDBAGS OR BACKFILLING TO KEY IN THE BOTTOM OF THE FABRIC WHERE IT IS NOT FEASIBLE TO TRENCH IT IN (LEDGES, ROCKY SOIL, LARGE ROOTS, ETC.)

**MAINTENANCE REQUIREMENTS:**

- INSPECT SILT FENCE:
  - ◆ DAILY IN AREAS OF ACTIVE CONSTRUCTION
  - ◆ WEEKLY IN AREAS WITH NO CONSTRUCTION
  - ◆ WITHIN 24 HOURS FOLLOWING EACH RAINFALL EVENT OF ≥ 0.5 INCH.
- REPAIR OR REPLACE SILT FENCE AS NEEDED
- REMOVE ACCUMULATED SEDIMENTS TO AN UPLAND AREA WHEN SEDIMENT REACHES 1/2 THE ABOVE GROUND HEIGHT OF THE SILT FENCE.

SILT FENCE DETAIL

FIGURE EC-1

DWG. ES-0011

REV.

Q:\S-U\SPE\2013-200.00\AutoCAD\Final\es0012.dwg

Wayne Siconora  
5/29/2014 7:30 AM

I.G. ES0012.DWG

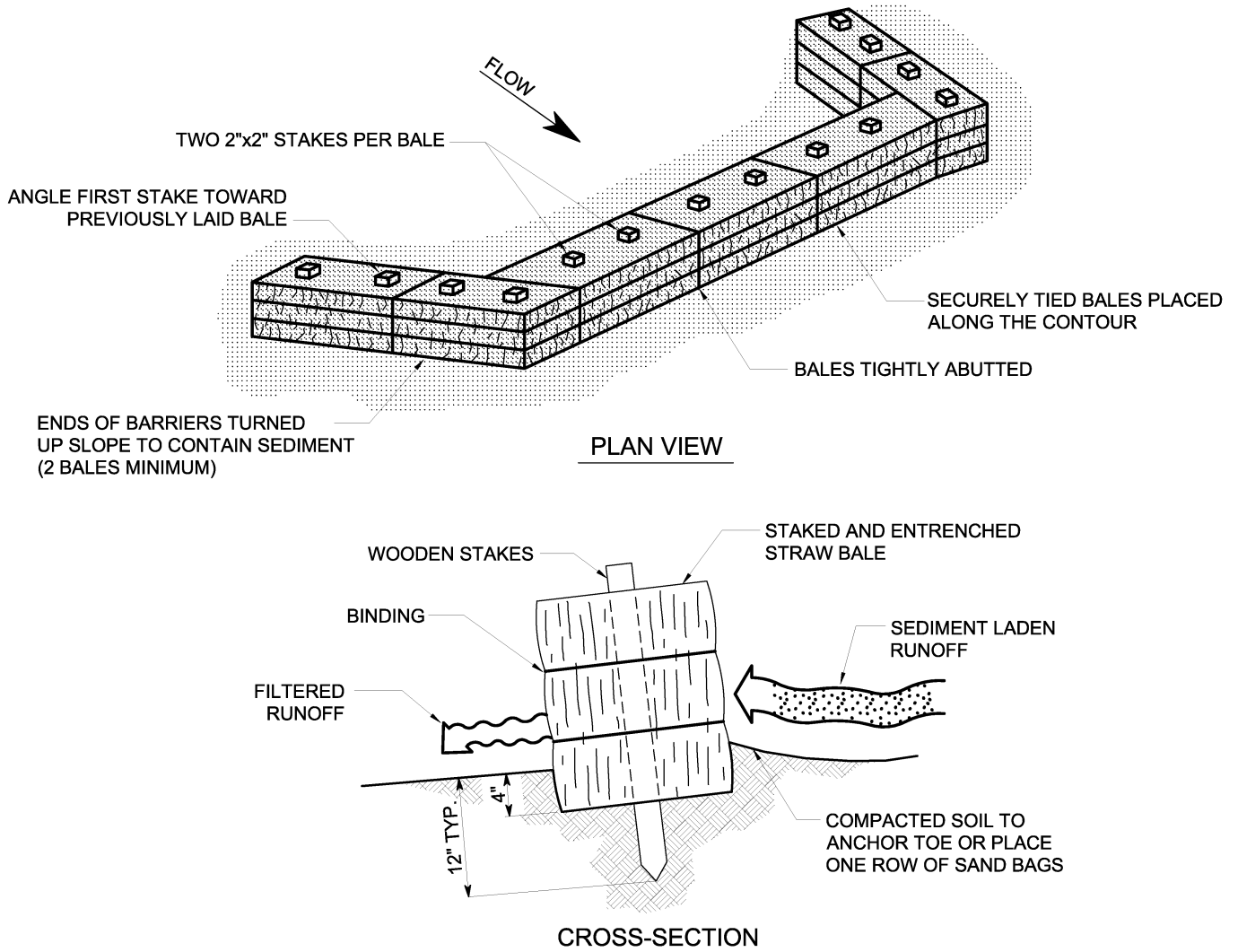

**INSTALLATION REQUIREMENTS:**

- WHEN USING STRAW BALES, PLACE THEM:
  - ◆ WITH THEIR ENDS TIGHTLY ABUTTING AND EMBEDDED IN THE SOIL A TYPICAL OF 4".
  - ◆ BETWEEN DISTURBED AREAS AND DOWN-SLOPE ENVIRONMENTAL RESOURCE AREAS.
  - ◆ AT THE BASE OF ALL SLOPES NEXT TO WETLANDS, WATERBODIES, AND ROAD CROSSINGS
  - ◆ AT THE INLET AND OUTLET OF OPEN DRAINAGE STRUCTURES.
  - ◆ APPROXIMATELY 6 FEET BEYOND THE TOE OF THE SLOPE TO GIVE THE SEDIMENT ROOM TO COLLECT.
- KEY IN THE BOTTOM OF THE BALE. IN AREAS WHERE IT IS NOT FEASIBLE TO TRENCH IT IN (LEDGES, ROCKY SOIL, LARGE TREE ROOTS, ETC.), USE NATIVE SOIL AS BACKFILL UP-SLOPE OF THE BALE OR PLACE ONE ROW OF SAND BAGS.
- DO NOT STAKE OR TRENCH IN PLACE STRAW BALES USED ON EQUIPMENT BRIDGES OR ON MATS ACROSS THE TRAVEL LANE.
- IF USED IN CONJUNCTION WITH SILT FENCE, BALES ARE PLACED DOWNSLOPE / UPSLOPE OF THE SILT FENCE AND DO NOT NEED TO BE TRENCHED IN.

**MAINTENANCE REQUIREMENTS:**

- INSPECT BALES:
  - ◆ DAILY IN AREAS OF ACTIVE CONSTRUCTION.
  - ◆ WEEKLY IN AREAS WITH NO CONSTRUCTION.
  - ◆ WITHIN 24 HOURS FOLLOWING EACH RAINFALL EVENT OF  $\geq 0.5$  INCH.
- REPAIR OR REPLACE BALES AS NEEDED.
- REMOVE ACCUMULATED SEDIMENTS TO AN UPLAND AREA AS NEEDED.

STRAW BALE DETAIL

FIGURE EC-2

DWG. ES-0012

REV.

Q:\S-U\SPE\2013-200.00\AutoCAD\Final\es0013.dwg

Wayne Sicono  
5/29/2014 7:35 AM

I.G. ES0013.DWG

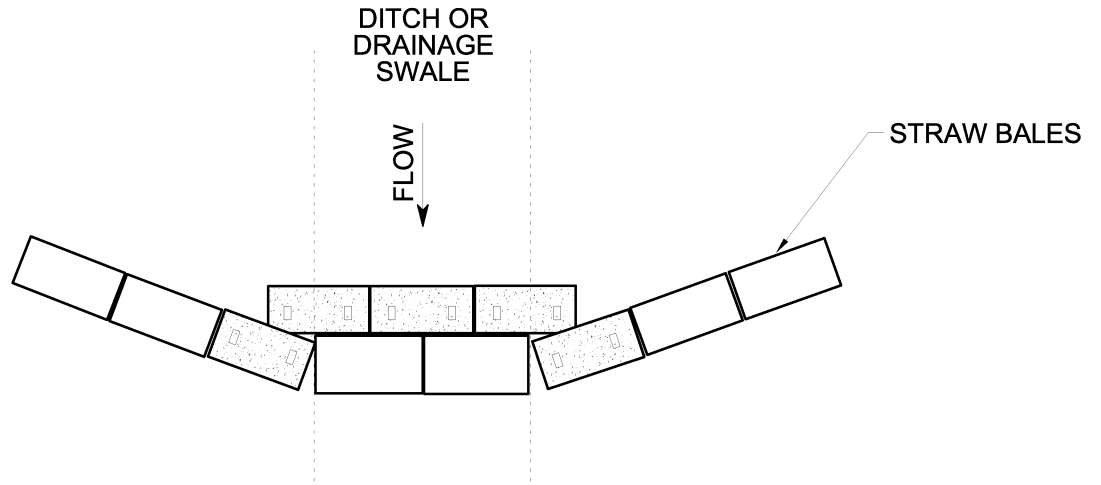

PLAN VIEW  
NOT TO SCALE

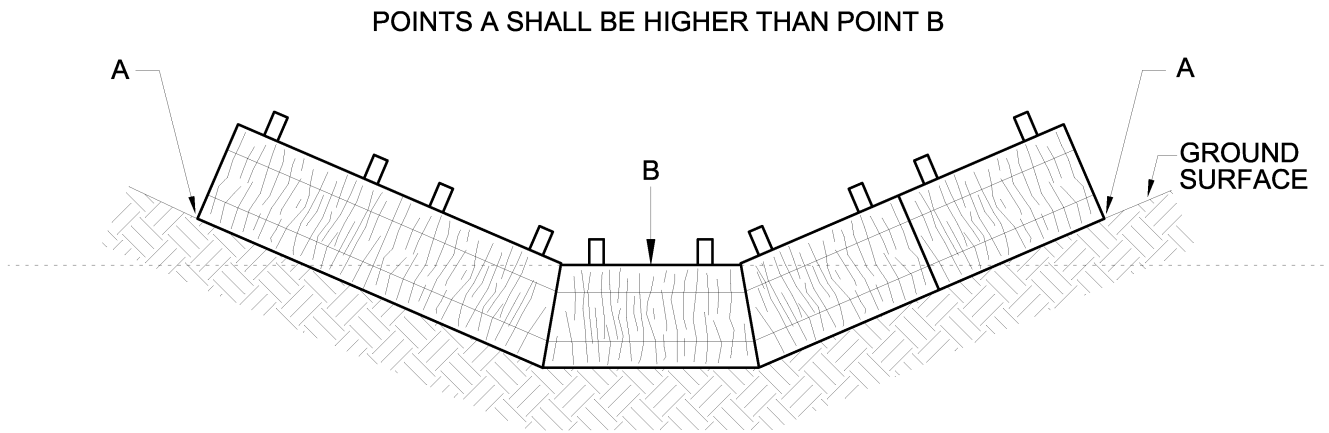

CROSS-SECTION  
NOT TO SCALE

NOTE:

1. THE NUMBER OF BALES IS DETERMINED BASED ON SITE SPECIFIC FACTORS.

STRAW BALE CHECK DAM  
IN A DRAINAGEWAY

FIGURE EC-3

DWG. ES-0013

REV.

Q:\S-U\SPE\2013-200.00\AutoCAD\Final\es0014.dwg

Wayne Siora  
5/29/2014 8:06 AM

I.G. ES0014.DWG

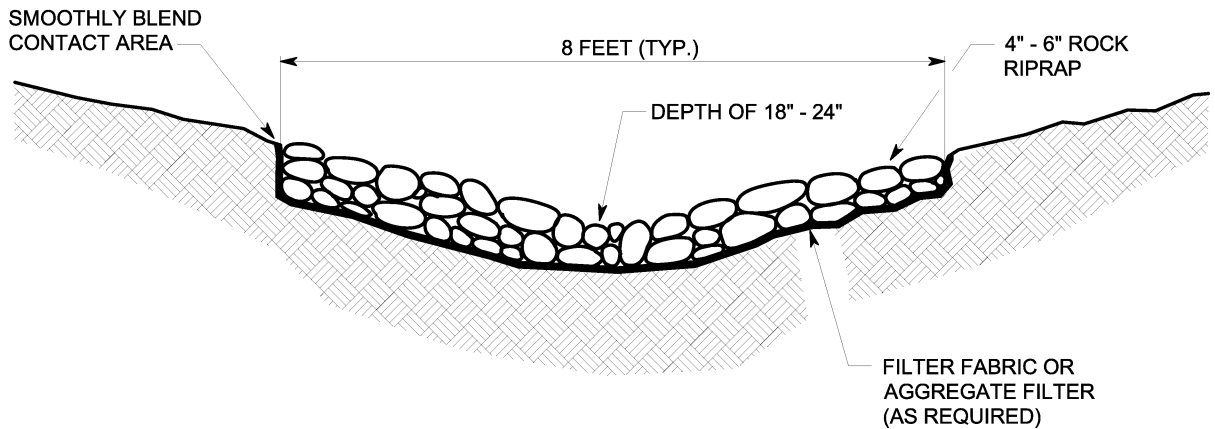

INSTALLATION REQUIREMENTS:

1. RIPRAP CHANNELS CAN BE CONSTRUCTED WITH GRASS-LINED SLOPES WHERE SITE CONDITIONS WARRANT.
2. STABILIZE CHANNEL INLET POINTS AND INSTALL OUTLET PROTECTION (AS NEEDED) DURING CHANNEL INSTALLATION.
3. INSTALL ENERGY DISSIPATING DEVICE (AS NEEDED) TO PREVENT SCOUR TO THE RECEIVING OUTLET.
4. REMOVE ALL TREES, BRUSH, AND OTHER OBJECTIONABLE MATERIAL FROM THE CHANNEL.
5. INSTALL FILTER FABRIC OR GRAVEL LAYER TO PREVENT PIPING (AS REQUIRED)

MAINTENANCE REQUIREMENTS:

1. INSPECT CHANNEL DURING AND FOLLOWING CONSTRUCTION AND MAKE REPAIRS AS NEEDED.
2. KEEP THE CHANNEL FREE OF DEBRIS AND OBSTRUCTIONS.

ROCK-LINED DRAINAGE SWALE

FIGURE EC-4

DWG. ES-0014

REV.

Q:\S-U\SPE\2013-200.00\AutoCAD\Final\es0015.dwg

Wayne Siorca  
5/29/2014 8:23 AM

I.G. ES0015.DWG

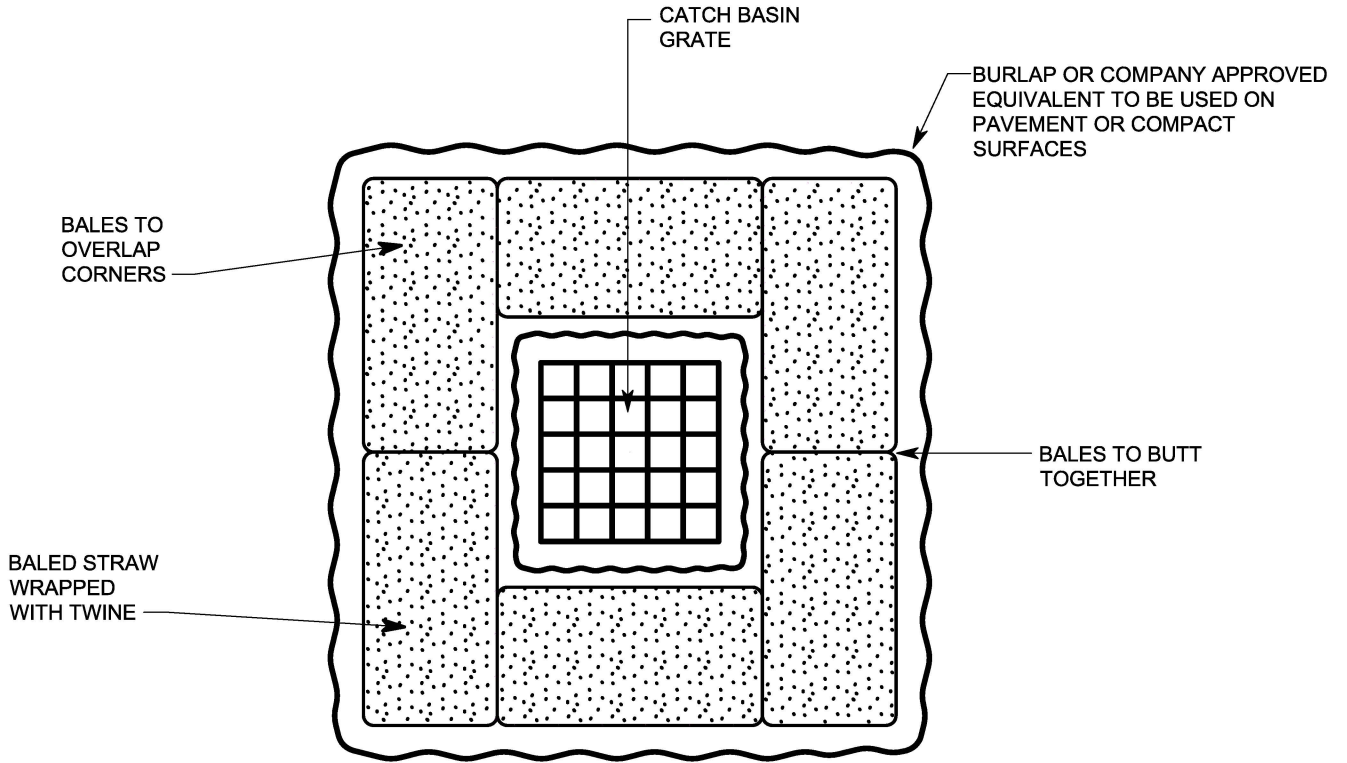

PLAN VIEW

NOTES:

1. SURROUND STREET DRAINAGE STRUCTURE INLET WITH STRAW BALES PRIOR TO CONSTRUCTION AND MAINTAIN UNTIL CONSTRUCTION IS COMPLETED.
2. FOR BALES PLACED ON PAVEMENT (OR COMPACT SURFACES), PLACE BURLAP OR COMPANY APPROVED EQUIVALENT BETWEEN PAVEMENT AND BALE.
3. REMOVE ACCUMULATED SEDIMENT.
4. AN ALTERNATIVE STORM DRAIN INLET PROTECTION MAY USE ONLY FABRIC LINING WITHOUT STRAW BALES BASED ON THE DISCRETION OF THE THE ENVIRONMENTAL INSPECTOR.

STORM DRAIN INLET PROTECTION

FIGURE EC-5

DWG. ES-0015

REV.

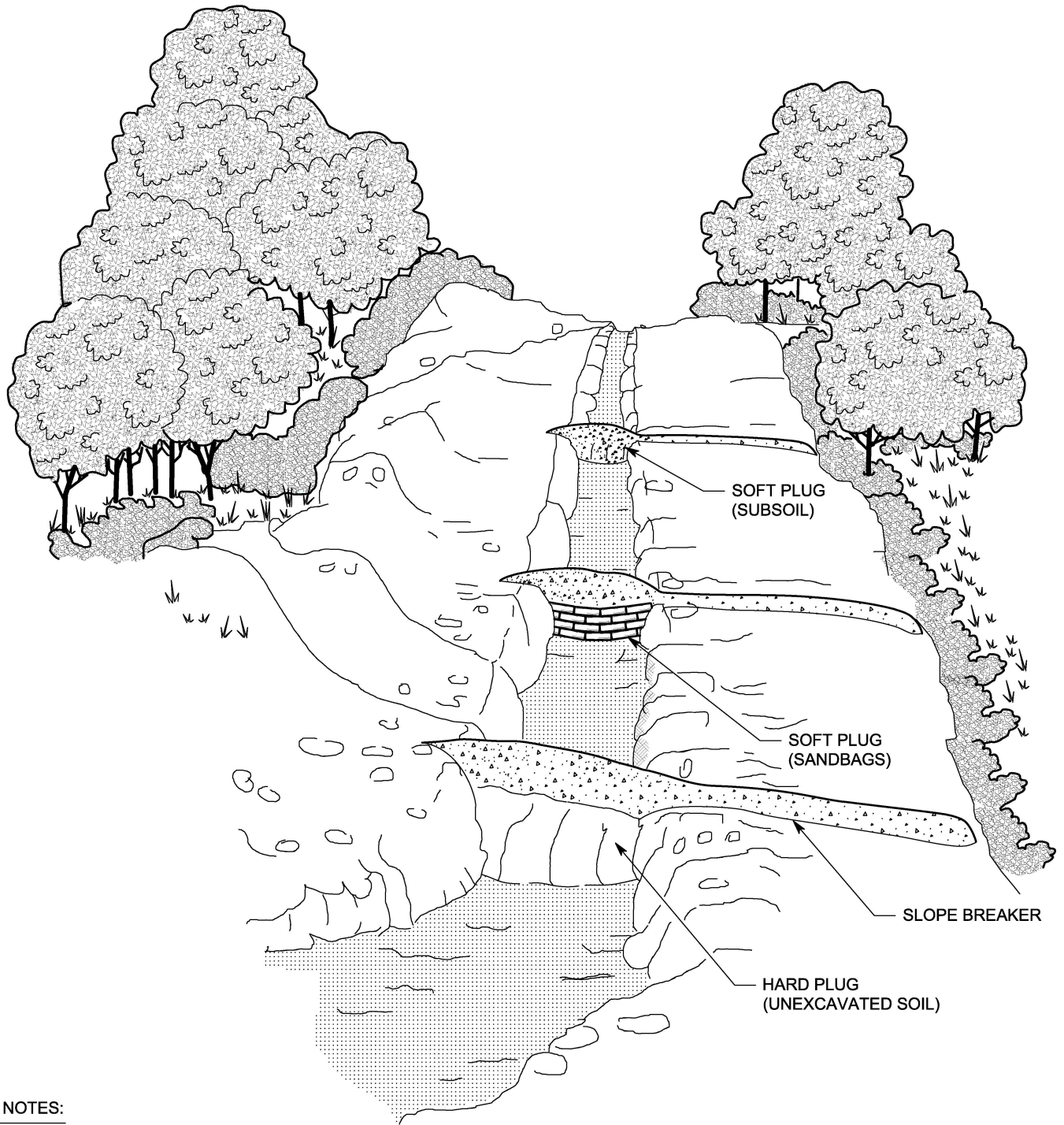

**NOTES:**

1. TEMPORARY TRENCH PLUG MATERIALS MAY CONSIST OF UNEXCAVATED PORTIONS OF THE TRENCH (HARD PLUG), COMPACTED SUBSOIL OR SANDBAGS PLACED ACROSS THE DITCH (SOFT PLUG), OR SOME FUNCTIONAL EQUIVALENT. THESE OPTIONS ARE DEPICTED ABOVE. DO NOT USE TOPSOIL FOR TRENCH PLUGS.
2. POSITION TEMPORARY TRENCH PLUGS, AS NECESSARY, TO REDUCE TRENCHLINE EROSION AND MINIMIZE THE VOLUME AND VELOCITY OF TRENCH WATER FLOW AT THE BASE OF SLOPES.
3. TEMPORARY TRENCH PLUGS MAY BE USED IN CONJUNCTION WITH SLOPE BREAKERS TO DIVERT TRENCH WATER OVERFLOW AND PREVENT OVERFLOW INTO SENSITIVE RESOURCE AREAS.
4. DIVERT TRENCH OVERFLOW TO A WELL-VEGETATED OFF-R.O.W. LOCATION OR INSTALL APPROPRIATE ENERGY DISSIPATING DEVICE.
5. USE TEMPORARY TRENCH PLUGS AT WATERBODY CROSSINGS, AS NECESSARY.

TEMPORARY TRENCH PLUG OPTIONS

FIGURE EC-6

Q:\S-U\SPE\2013-200.00\AutoCAD\Final\es0017.dwg

Wayne Siora  
6/3/2014 11:09 AM

I.G. ES0017.DWG

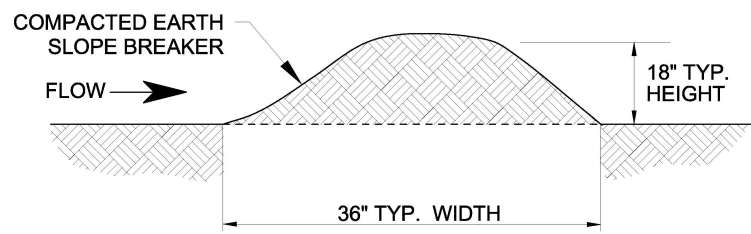

**CROSS-SECTION**  
NOT TO SCALE

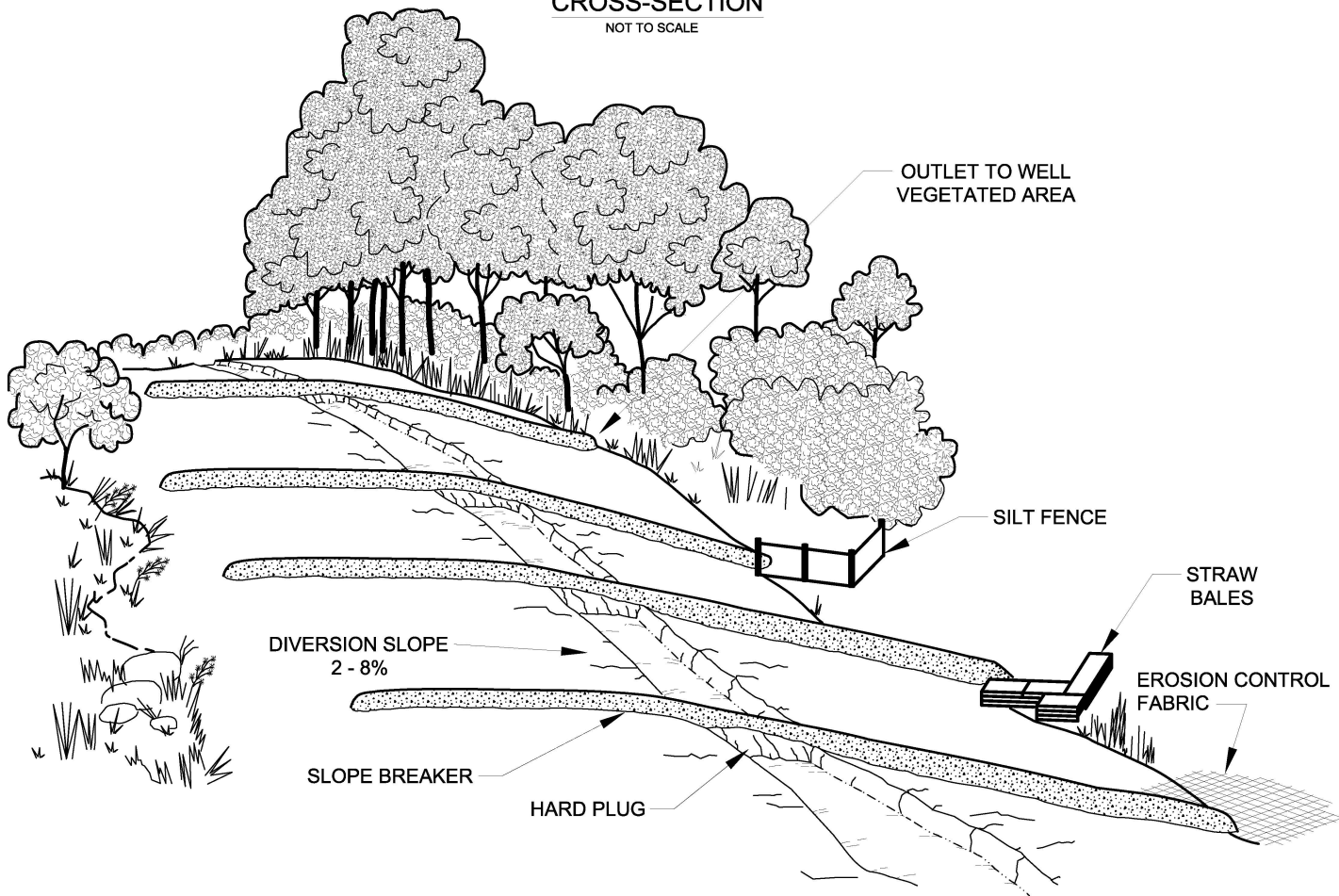

**INSTALLATION REQUIREMENTS:**

- INSTALL SLOPE BREAKERS IN ALL DISTURBED AREAS AS NECESSARY TO AVOID EXCESSIVE EROSION AT THE LOCATIONS SHOWN ON THE CONSTRUCTION DRAWINGS OR AS APPROVED BY THE ENVIRONMENTAL INSPECTOR (EI).
- MUST BE INSTALLED ON SLOPES GREATER THAN 5% WHERE THE BASE OF THE SLOPE IS LESS THAN 50 FEET FROM A WATERBODY, WETLAND OR ROAD CROSSING AT THE FOLLOWING MINIMUM SPACING:

SLOPE (%)	SPACING (FT.)
5 - 15	300
> 15 - 30	200
> 30	100

- CONSTRUCT USING SAND BAGS, STAKED STRAW BALES, SILT FENCE, OR SOIL.
- INSTALL WITH A 2 - 8% OUTFALL ANGLE.

- POSITION OUTFALL TO PREVENT SEDIMENT DISCHARGE INTO WETLANDS, WATERBODIES, OR OTHER SENSITIVE RESOURCES.
- FILTER RUN-OFF WATER BY CONSTRUCTING THE OUTFALL IN A WELL VEGETATED STABLE AREA, OR BY USING AN ENERGY DISSIPATING DEVICE (SILT FENCE, STRAW BALES, EROSION CONTROL FABRIC). IF NEEDED, THE TYPE OF ENERGY DISSIPATION DEVICE WILL DEPEND ON SITE CONDITIONS (OPTIONS ARE DEPICTED ABOVE).

**MAINTENANCE REQUIREMENTS:**

- INSPECT DURING CONSTRUCTION AND MAKE REPAIRS AS NEEDED.
- KEEP THE CHANNEL FREE OF DEBRIS AND OBSTRUCTIONS.

**TEMPORARY SLOPE BREAKERS**

**FIGURE EC-7**

DWG. **ES-0017** REV.

Q:\S-U\SPE\2013-200.00\AutoCAD\Final\es0018.dwg

Wayne Sicora  
6/3/2014 11:29 AM

I.G. ES0018.DWG

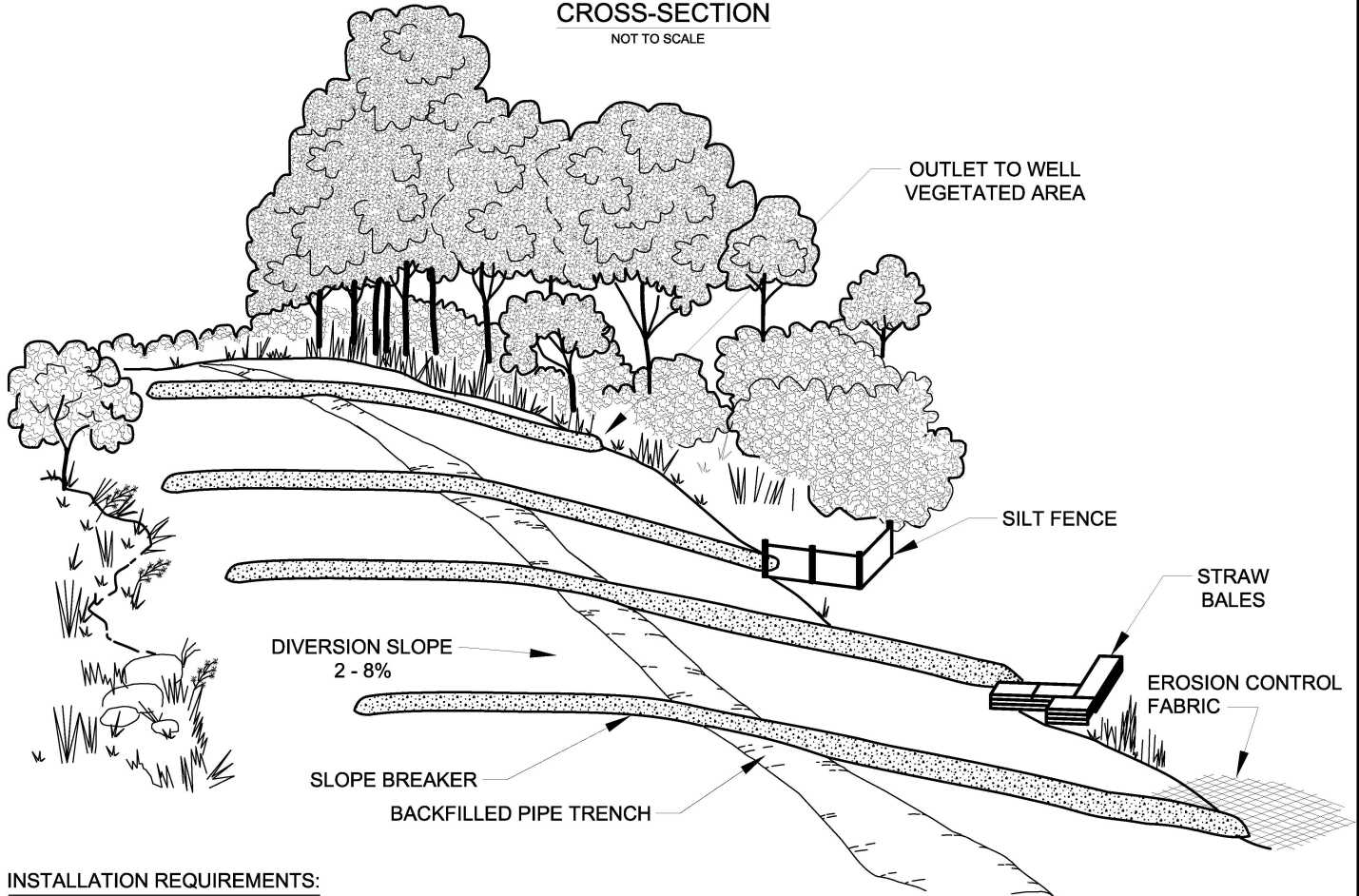
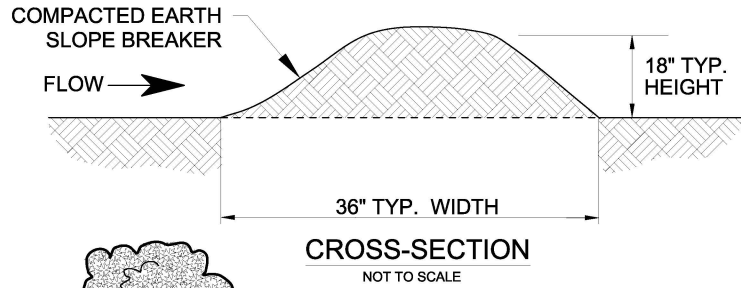

**INSTALLATION REQUIREMENTS:**

- INSTALL AND MAINTAIN IN ALL DISTURBED AREAS TO AVOID EXCESSIVE EROSION, EXCEPT CULTIVATED AREAS AND LAWNS (UNLESS REQUESTED BY THE LANDOWNER), USING SPACING RECOMMENDATIONS OBTAINED FROM THE LOCAL SOIL CONSERVATION AUTHORITY OR LAND MANAGEMENT AGENCY, AT THE LOCATIONS SHOWN ON THE CONSTRUCTION DRAWINGS OR AS APPROVED BY THE ENVIRONMENTAL INSPECTOR (EI).
- INSTALL ON SLOPES GREATER THAN 5% WHERE THE BASE OF THE SLOPE IS LESS THAN 50 FEET FROM A WATERBODY, WETLAND OR ROAD CROSSING AT THE FOLLOWING MINIMUM SPACING IN THE ABSENCE OF WRITTEN RECOMMENDATIONS:
 

SLOPE (%)	SPACING (FT.)
5 - 15	300
> 15 - 30	200
> 30	100
- CONSTRUCT USING SOIL, STONE, OR SOME FUNCTIONAL EQUIVALENT.
- INSTALL WITH A 2 - 8% OUTFALL ANGLE.
- POSITION OUTFALL TO PREVENT SEDIMENT DISCHARGE INTO WETLANDS, WATERBODIES, OR OTHER SENSITIVE RESOURCES.

- FILTER RUN-OFF WATER BY CONSTRUCTING THE OUTLET IN A WELL VEGETATED STABLE AREA, OR BY USING AN ENERGY DISSIPATING DEVICE (SILT FENCE, STRAW BALES, EROSION CONTROL FABRIC). IF NEEDED, THE TYPE OF ENERGY DISSIPATING DEVICE WILL DEPEND ON SITE CONDITIONS (OPTIONS ARE DEPICTED ABOVE).
- IF NECESSARY, OUTFALL MAY EXTEND SLIGHTLY, UP TO 4 FEET, BEYOND THE EDGE OF THE CONSTRUCTION RIGHT-OF-WAY, SUBJECT TO ALL APPLICABLE SURVEY REQUIREMENTS.

**MAINTENANCE REQUIREMENTS:**

- INSPECT DURING AND FOLLOWING CONSTRUCTION AND MAKE REPAIRS AS NEEDED.
- KEEP THE CHANNEL FREE OF DEBRIS AND OBSTRUCTIONS.
- SEED AND MULCH PERMANENT SLOPE BREAKERS FOLLOWING CONSTRUCTION.

**PERMANENT SLOPE BREAKERS**

**FIGURE EC-8**

DWG. **ES-0018**

REV.

Q:\S-U\SPE\2013-200.00\AutoCAD\Final\es0019.dwg

Wayne Siorco  
5/29/2014 10:44 AM

I.G. ES0019.DWG

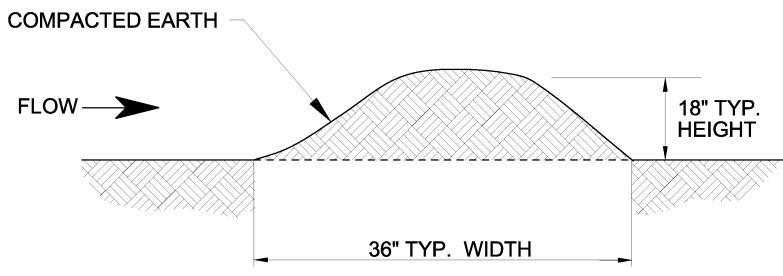

**CROSS-SECTION**  
NOT TO SCALE

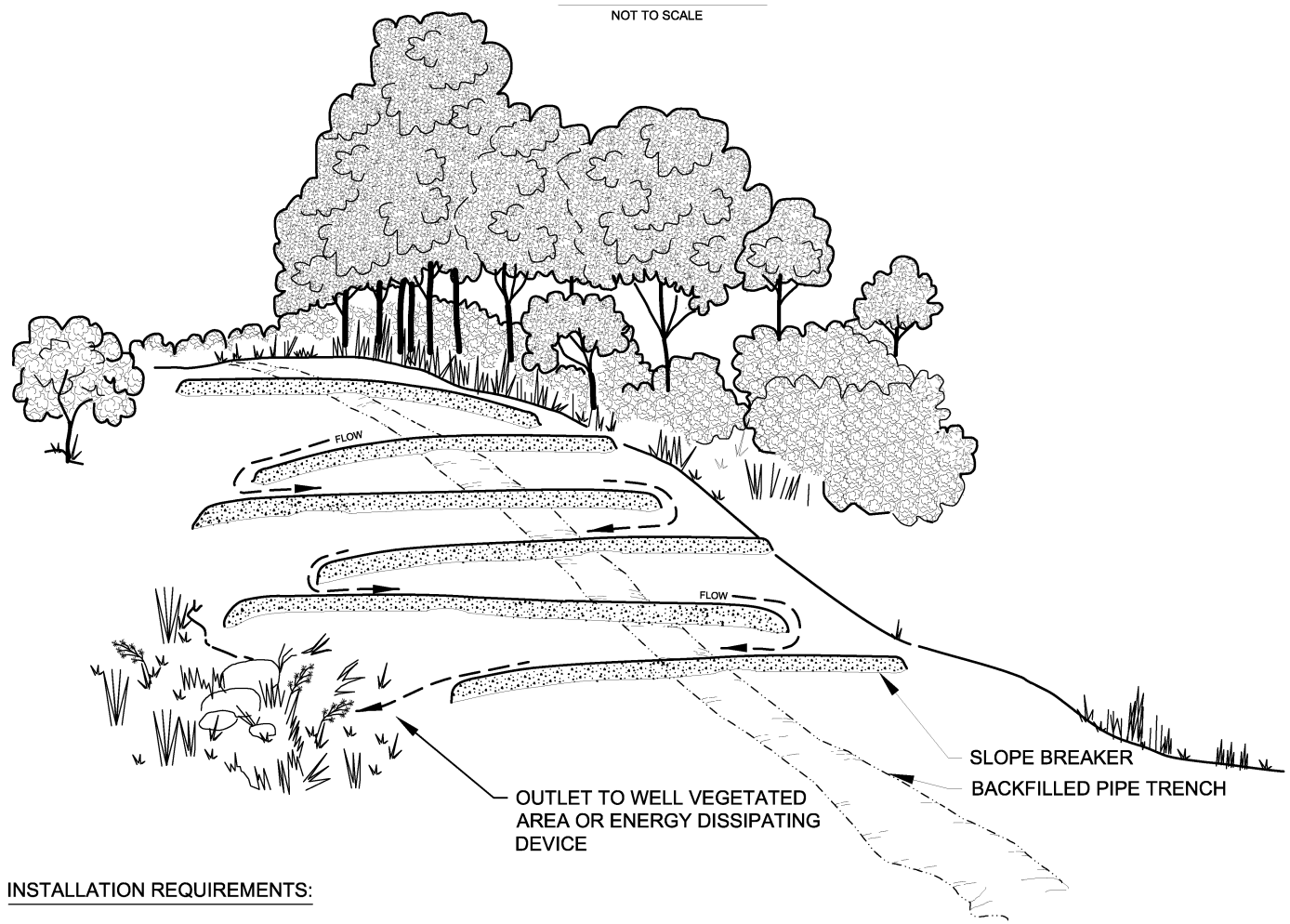

**INSTALLATION REQUIREMENTS:**

- INSTALL IN ALL AREAS EXCEPT RESIDENTIAL OR AGRICULTURAL (UNLESS AUTHORIZED BY LANDOWNER OR LAND MANAGING AGENCY).
- CONSTRUCT USING EARTH FILLED SACKS OR STAKED STRAW BALES FOR TEMPORARY OR COMPACTED EARTH AND ROCK FOR PERMANENT.
- INSTALL WITH A 2 - 8% OUTFALL ANGLE.
- FOR TEMPORARY CHEVRON SLOPE BREAKERS, POSITION OUTFALL TO PREVENT SEDIMENT DISCHARGE INTO WETLANDS, WATERBODIES, OR OTHER SENSITIVE RESOURCES.
- FILTER RUN-OFF WATER BY CONSTRUCTING AN OUTLET USING AN ENERGY DISSIPATING DEVICE (SILT FENCE, STRAW BALES, EROSION CONTROL FABRIC), AS APPROVED BY THE ENVIRONMENTAL INSPECTOR.

**MAINTENANCE REQUIREMENTS:**

- INSPECT DURING AND FOLLOWING CONSTRUCTION AND MAKE REPAIRS AS NEEDED.
- KEEP THE CHANNEL FREE OF DEBRIS AND OBSTRUCTIONS.
- SEED AND MULCH PERMANENT SLOPE BREAKERS FOLLOWING CONSTRUCTION.

**CHEVRON SLOPE BREAKER**

**FIGURE EC-9**

DWG. ES-0019	REV.
--------------	------

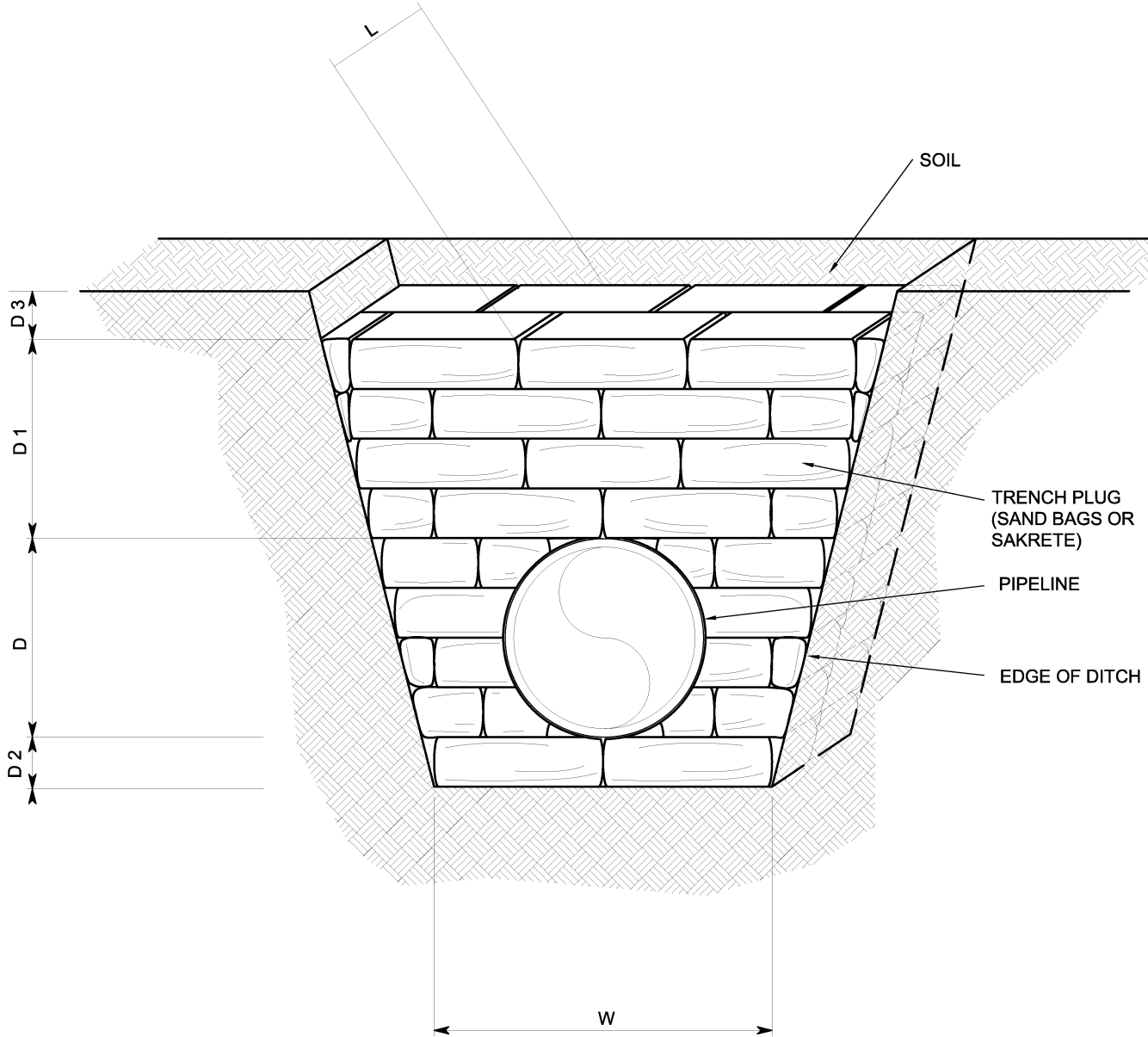

D = PIPE DIAMETER  
 D1 = APPROXIMATELY 24"  
 D2 = APPROXIMATELY 6" (8" MIN. IN ROCK)  
 D3 = APPROXIMATELY 12"  
 W = D + 2 TO 4 FEET  
 L = APPROXIMATELY 18" - 24"  
 D1 + D3 = 36" MINIMUM

**NOTE:**

1. USE OF SAKRETE SHALL REQUIRE PRIOR COMPANY APPROVAL.
2. TOPSOIL SHALL NOT BE USED TO CONSTRUCT BREAKERS.
3. DO NOT INSTALL TRENCH BREAKERS WITHIN A WETLAND.

TRENCH BREAKER DETAIL (SACK)

FIGURE EC-10

DWG. ES-0020

REV.

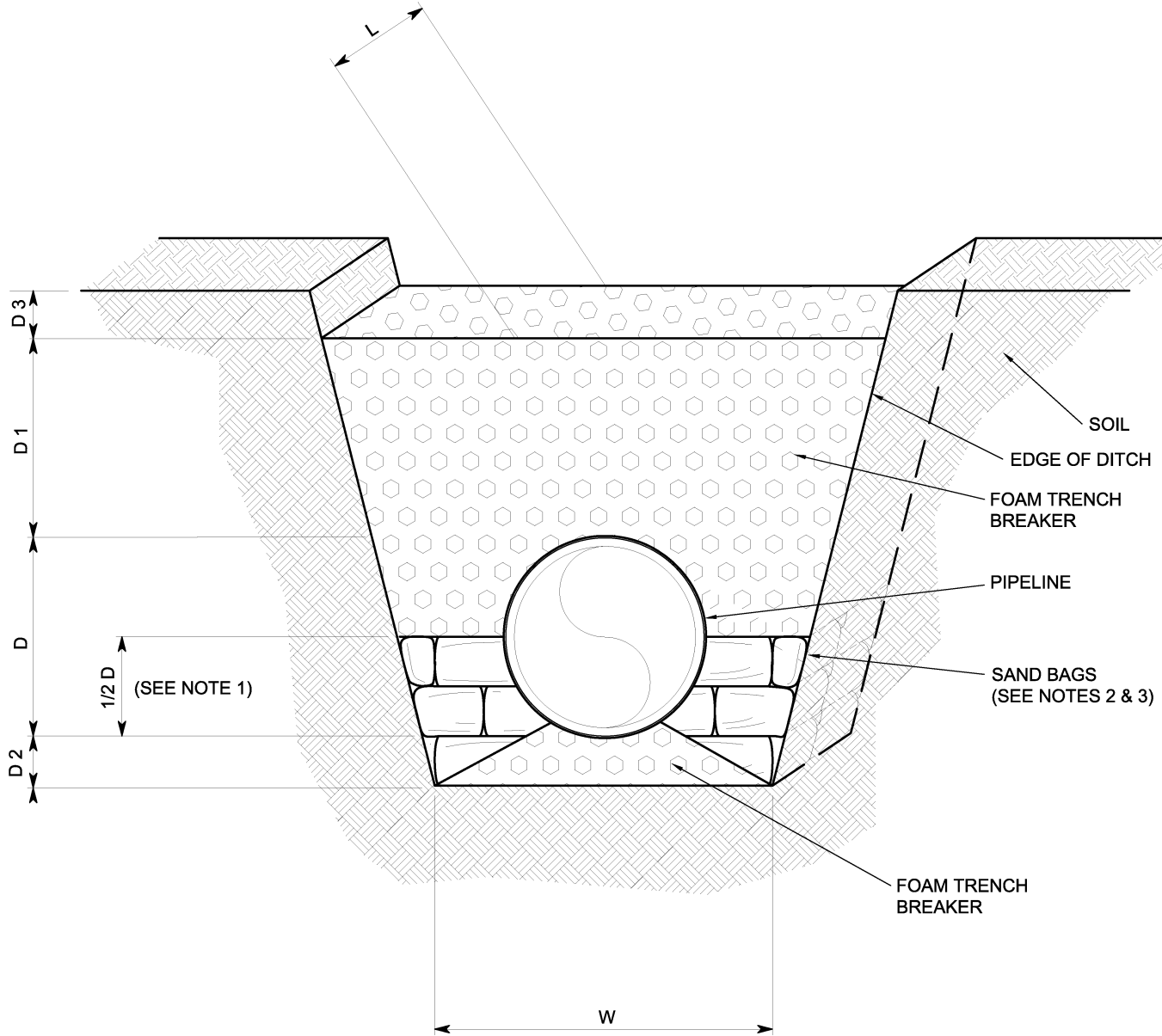

D = PIPE DIAMETER  
 D1 = APPROXIMATELY 24"  
 D2 = APPROXIMATELY 6" (8" MIN. IN ROCK)  
 D3 = APPROXIMATELY 12"  
 W = D + 2 TO 4 FEET  
 L = APPROXIMATELY 18" - 24"  
 D1 + D3 = 36" MINIMUM

**NOTE:**

1. A MINIMUM OF TWO LAYERS OF BAGS SHALL BE INSTALLED.
2. THE ADDITION OF SAND BAGS UNDER THE FOAM WILL BE PLACED AS PRESCRIBED IN THE E&S PLAN OR AT THE DISCRETION OF THE ENVIRONMENTAL INSPECTOR (EI).
3. FOAM TRENCH BREAKERS ARE TO BE USED WITHIN UPLAND AREAS. DO NOT USE FOAM TRENCH BREAKERS AT WATERBODY OR WETLAND BOUNDARIES..

TRENCH BREAKER DETAIL (FOAM)

FIGURE EC-11

DWG. ES-0021

REV.

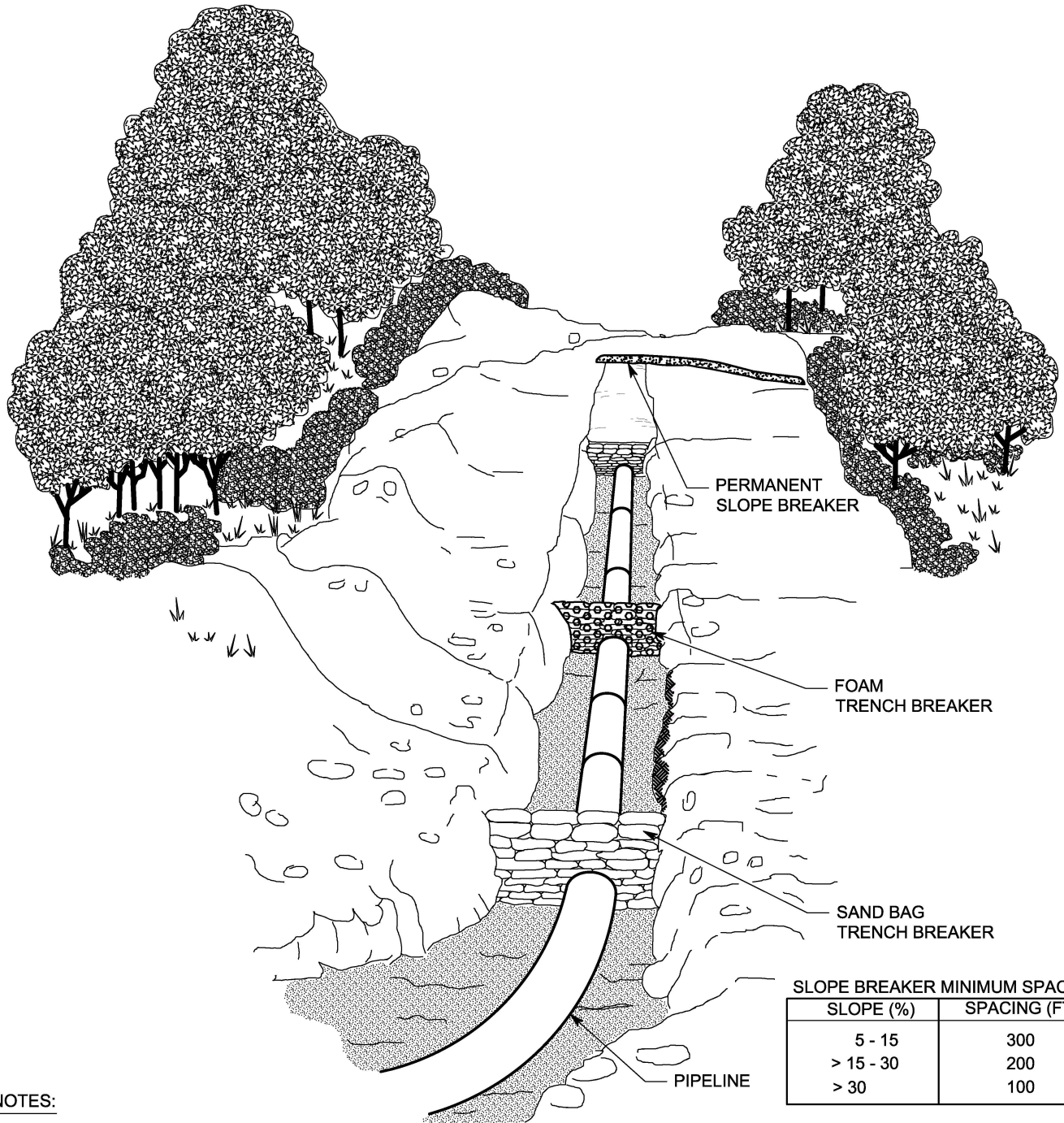

**NOTES:**

1. PERMANENT TRENCH BREAKER MATERIALS WILL CONSIST OF SAND BAGS, POLYURETHANE FOAM OR SOME FUNCTIONAL EQUIVALENT PLACED ACROSS THE DITCH AS IDENTIFIED IN PERMIT REQUIREMENTS. DO NOT USE TOPSOIL FOR TRENCH BREAKERS. THESE OPTIONS ARE DEPICTED ABOVE.
2. PERMANENT TRENCH BREAKERS, WHICH ARE USED IN CONJUNCTION WITH SLOPE BREAKERS, SHALL BE INSTALLED AT THE LOCATIONS SHOWN ON THE CONSTRUCTION DRAWINGS OR AS DETERMINED IN THE FIELD BY THE ENVIRONMENTAL INSPECTOR.
3. AT A MINIMUM, INSTALL A TRENCH BREAKER AT THE BASE OF SLOPES GREATER THAN 5 PERCENT WHERE THE BASE OF THE SLOPE IS LESS THAN 50 FEET FROM A WATERBODY OR WETLAND AND WHERE NEEDED TO AVOID DRAINING A WATERBODY OR WETLAND.
4. INSTALL TRENCH BREAKERS AT WETLAND BOUNDARIES AND/OR SEAL THE TRENCH BOTTOM AS NECESSARY TO MAINTAIN THE ORIGINAL WETLAND HYDROLOGY. DO NOT INSTALL TRENCH BREAKERS WITHIN A WETLAND.
5. IN AGRICULTURAL FIELDS AND RESIDENTIAL AREAS WHERE SLOPE BREAKERS ARE NOT TYPICALLY REQUIRED, INSTALL TRENCH BREAKERS AT THE SAME SPACING AS IF PERMANENT SLOPE BREAKERS WERE REQUIRED.

PERMANENT TRENCH BREAKER OPTIONS

FIGURE EC-12

A. BURY THE TOP END OF THE ROLL IN A 6" TRENCH (TYPICAL)

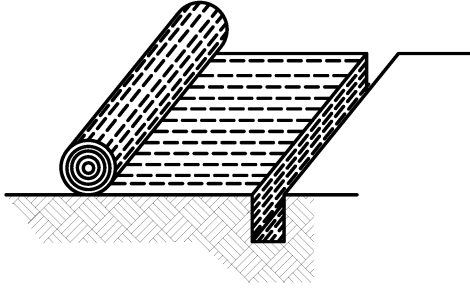

B. DOUBLE STAPLE EVERY 12" BEFORE BACKFILLING AND COMPACTING.

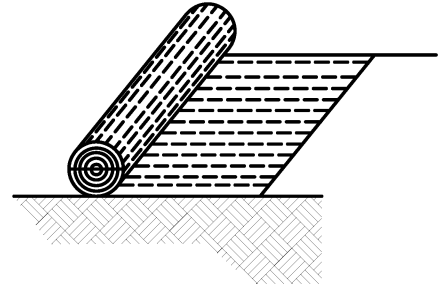

C. BURY AND TAMP UPPER END OF LOWER STRIP AS IN "A" AND "B". OVERLAP END OF TOP STRIP 4" AND STAPLE.

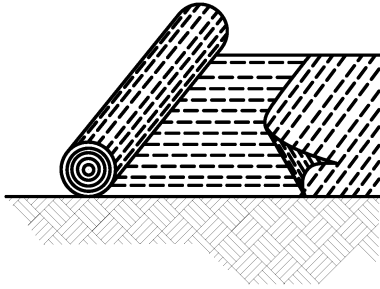

D. WHERE FABRIC STOPS, FOLD, BURY, AND TAMP ROLL IN SLIT TRENCH. PROVIDE DOUBLE ROW OF STAPLES

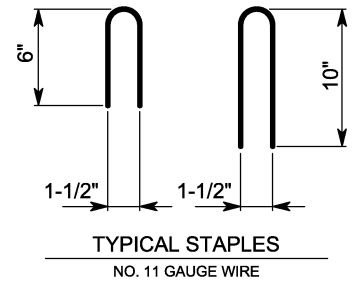
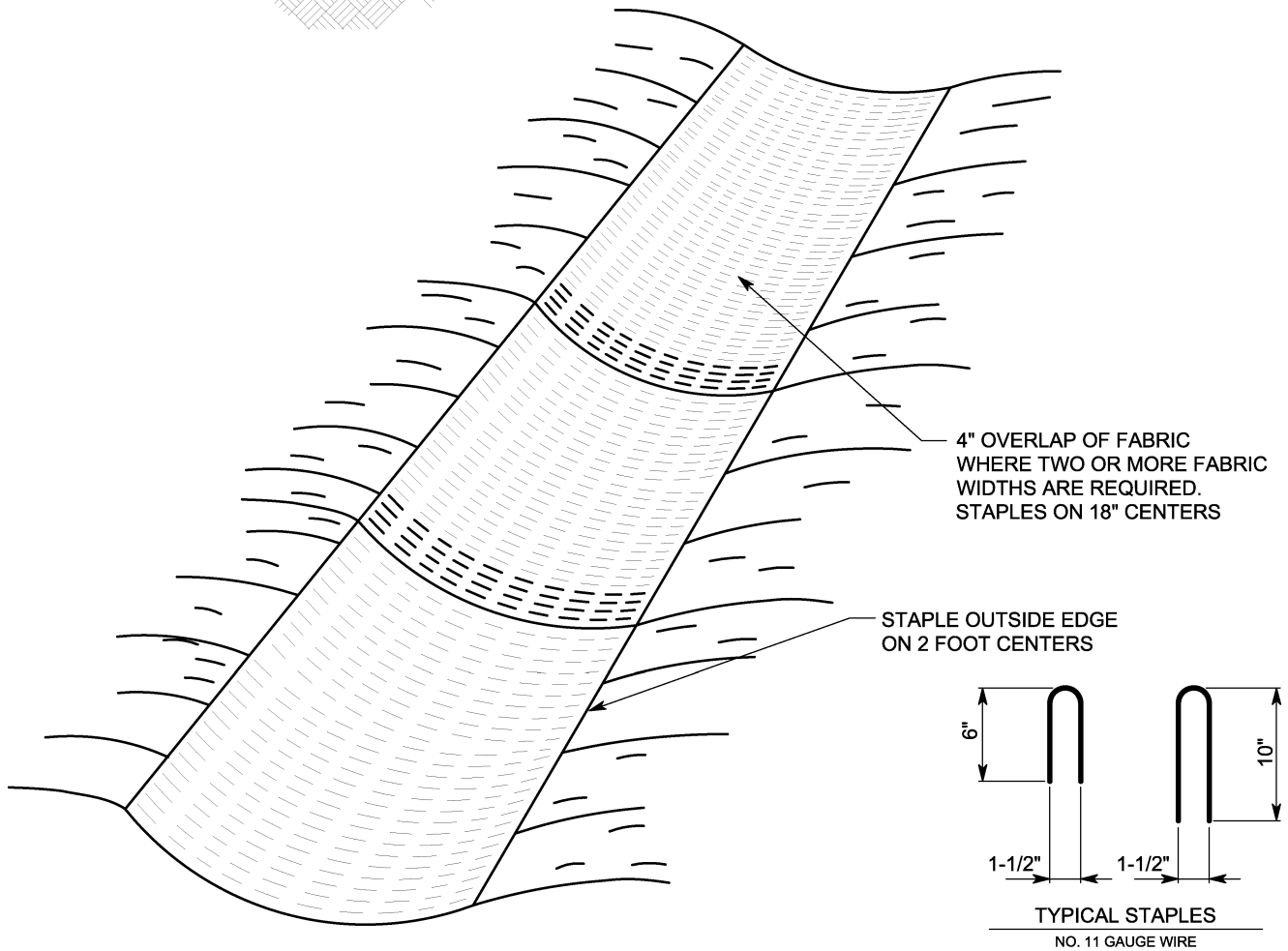
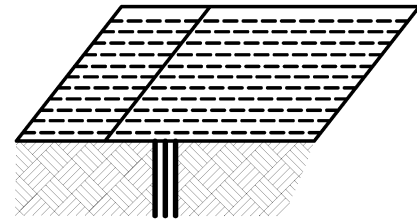

Q:\S-U\SPE\2013-200.00\AutoCAD\Final\es0023.dwg

Wayne Sicora  
5/29/2014 12:06 PM

I.G. ES0023.DWG

EROSION CONTROL  
FABRIC INSTALLATION

FIGURE EC-13

DWG. ES-0023

REV.

Q:\S-U\SPE\2013-200.00\AutoCAD\Final\es0024.dwg

Wayne Sicora  
6/10/2014 10:30 AM

I.G. ES0024.DWG

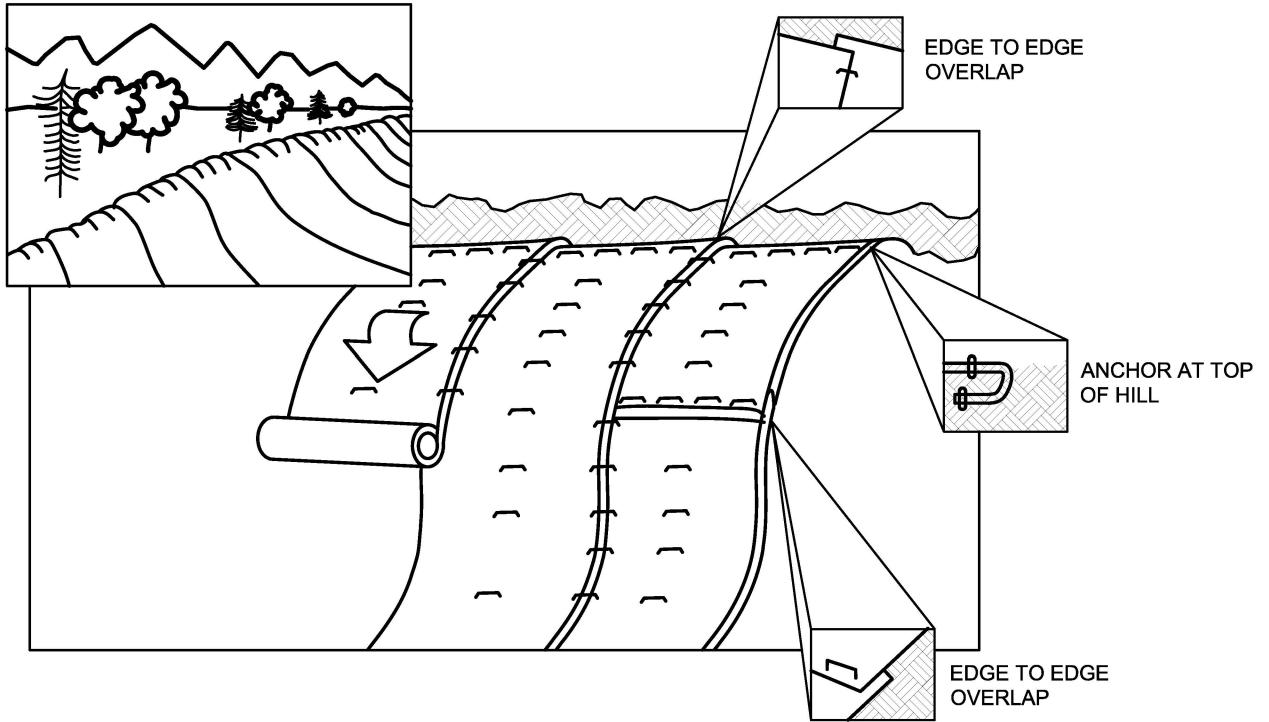

**NOTES:**

1. EROSION CONTROL BLANKETS (FABRIC) SHALL BE USED AT LOCATIONS IDENTIFIED IN THE PLAN AND/OR AS DIRECTED BY THE ENVIRONMENTAL INSPECTOR.
2. EROSION CONTROL BLANKETS SHALL MEET THE REQUIREMENTS SPECIFIED IN THE PLAN AND/OR AS DIRECTED BY THE ENVIRONMENTAL INSPECTOR.
3. STAPLES SHALL BE MADE OF 11 GAUGE WIRE, U-SHAPED WITH 6" LEGS AND A 1" CROWN. STAPLES SHALL BE DRIVEN INTO THE GROUND FOR THE FULL LENGTH OF THE STAPLE LEGS.
4. BLANKETS SHALL BE INSTALLED ACCORDING TO MANUFACTURER SPECIFICATIONS OR AS STATED BELOW:
  - EXTEND TOP OF BLANKET 3 FEET PAST THE UPPER EDGE OF THE SLOPE.
  - ANCHOR ("KEY") THE UPPER EDGE OF THE BLANKET INTO THE SLOPE USING A 6" DEEP TRENCH AND ROLL THE BLANKET DOWN THE HILL. DOUBLE STAPLE EVERY 12" BEFORE BACKFILLING AND COMPACTING TRENCH.
  - INSTALL LOOSELY ON SLOPE AND AVOID STRETCHING EROSION CONTROL BLANKETS DURING INSTALLATION.
  - BRING ROLL BACK OVER THE TOP OF THE TRENCH AND CONTINUE TO ROLL DOWN SLOPE. STAPLE EVERY 12" WHERE BLANKETS EXIT THE TRENCH AT THE TOP OF THE SLOPE.
  - WHEN BLANKETS ARE SPLICED DOWN-SLOPE TO ADJOINING BLANKETS (SLOPE OR STREAMBANK MATS), THE UPPER BLANKET SHALL BE PLACED OVER THE LOWER (SHINGLE STYLE) WITH APPROXIMATELY 6" OF OVERLAP. STAPLE THROUGH THE OVERLAPPED AREA EVERY 12".
  - OVERLAP ADJACENT BLANKETS 6". STAPLE EDGES OF BLANKETS AND CENTER EVERY 36".
5. IN LIVESTOCK AREAS WHERE EROSION CONTROL BLANKETS ARE APPLIED TO THE SLOPES, FENCING WILL BE USED IF NECESSARY TO EXCLUDE LIVESTOCK, WITH PERMISSION OF THE LANDOWNER.
6. MONITOR WASHOUTS, STAPLE INTEGRITY OR BLANKET MOVEMENT. REPLACE OR REPAIR AS NECESSARY.
7. DO NOT USE SYNTHETIC MONOFILAMENT MESH / NETTED MATERIALS IN AREAS DESIGNATED AS SENSITIVE WILDLIFE HABITAT, UNLESS THE PRODUCT IS SPECIFICALLY DESIGNED TO MINIMIZE HARM TO WILDLIFE.

**TYPICAL EROSION CONTROL  
BLANKETS ON SLOPES**

**FIGURE EC-14**

DWG. **ES-0024**

REV.

Q:\S-U\SPE\2013-200.00\AutoCAD\Final\es0025.dwg

Wayne Siorco  
5/29/2014 1:56 PM

I.G. ES0025.DWG

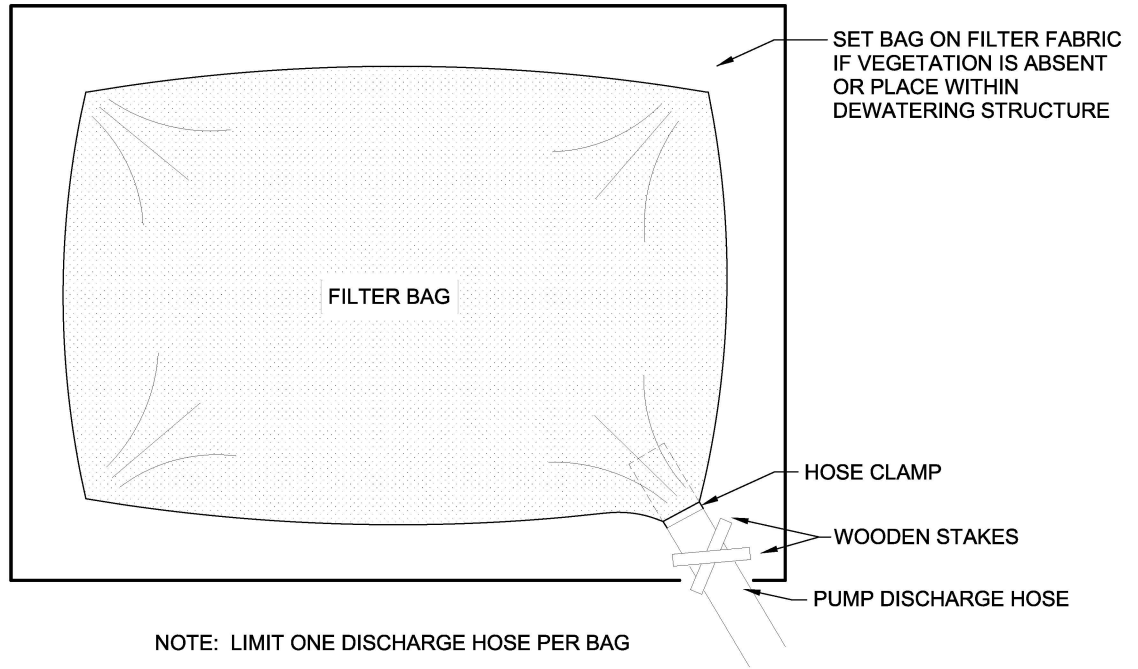

NOTE: LIMIT ONE DISCHARGE HOSE PER BAG

PLAN VIEW

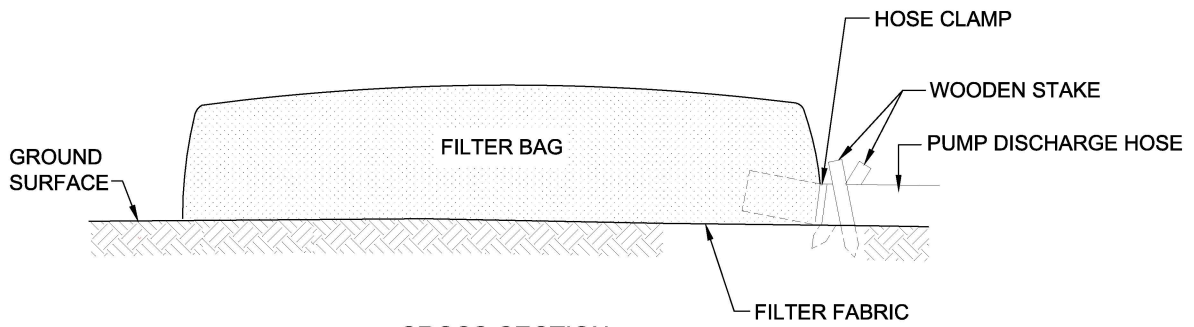

CROSS-SECTION

NOTES:

1. THE FILTER BAG OR STRUCTURE MUST BE MANNED WHEN THE PUMPING IS INITIATED TO ENSURE PROPER OPERATION AND FUNCTIONALITY.
2. REMOVE DEWATERING STRUCTURE AS SOON AS PRACTICABLE AFTER COMPLETION OF DEWATERING ACTIVITIES.
3. PLACEMENT OF FILTERBAGS SHOULD BE IN A MANNER THAT BAG USE DOES NOT CAUSE EROSION. IF SITE CONDITIONS ALLOW, PLACE FILTER BAG IN WELL-VEGETATED AREA, A MINIMUM OF 50 FEET FROM WETLANDS OR WATERBODIES.

FILTER BAG

FIGURE WD-1

DWG. ES-0025

REV.

Q:\S-U\SPE\2013-200.00\AutoCAD\Final\es0026.dwg

Wayne Sicora  
5/29/2014 1:58 PM

I.G. ES0026.DWG

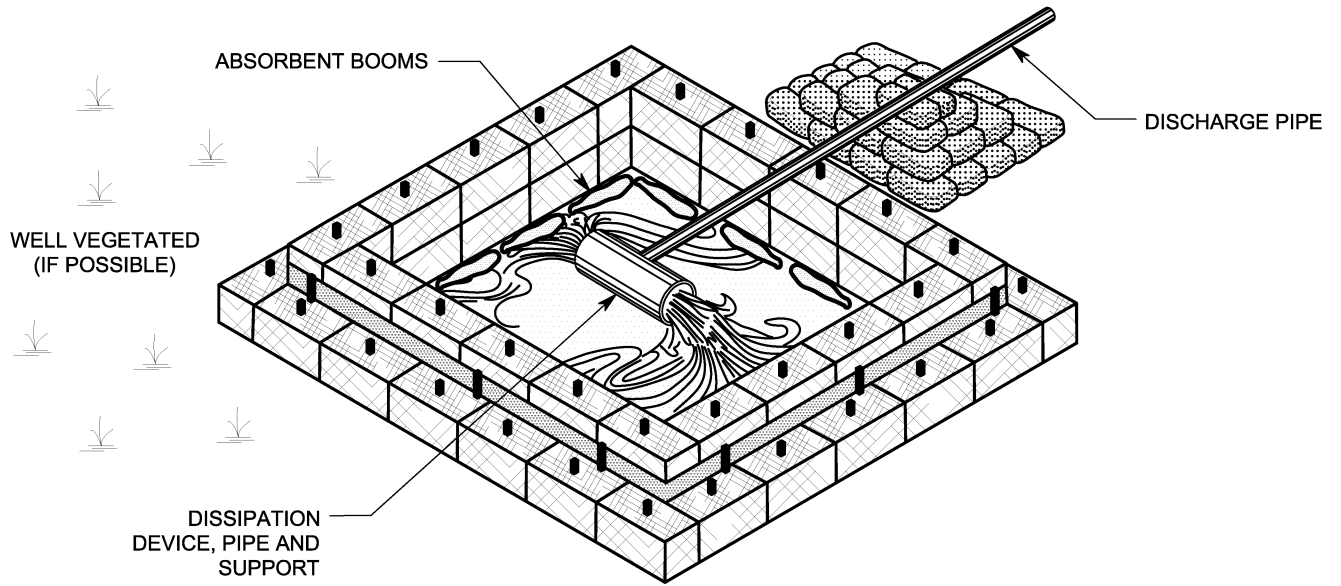

PLAN VIEW

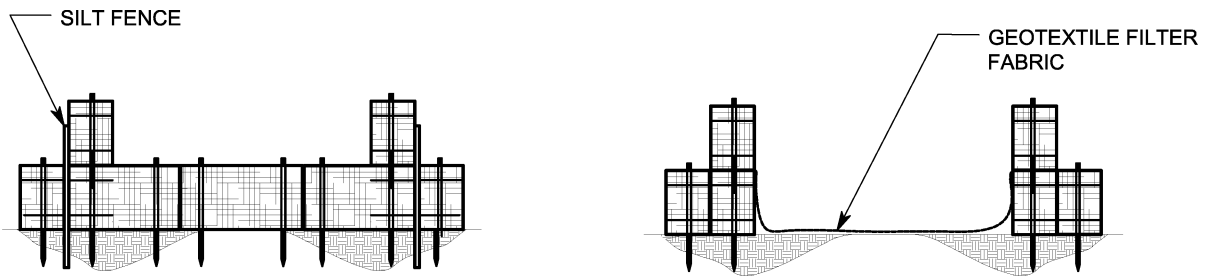

OPTION 1

OPTION 2

CROSS SECTION VIEWS

NOTES:

1. SIZE AND DIMENSION OF DEWATERING STRUCTURE WILL VARY DEPENDING ON THE VOLUME AND RATE OF DISCHARGE. STAGGER PLACEMENT OF STRAW BALES WHEN TWO ROWS ARE USED.
2. COVER THE BASE OF THE DISCHARGE STRUCTURE EITHER WITH STRAW BALES (OPTION 1) OR LINE WITH GEOTEXTILE FABRIC (OPTION 2).
3. PROVIDE SUPPORT TO ENSURE THAT DISCHARGE PIPE DOES NOT REST ON STRAW BALES.
4. PLASTIC SHEETING, WOODEN MATS OR STEEL PLATES MAY ALSO BE USED, AS DIRECTED BY THE ENVIRONMENTAL INSPECTOR, TO PREVENT EROSION, STREAMBED SCOUR, SUSPENSION OF SEDIMENTS OR EXCESSIVE STREAMFLOW.
5. ABSORBENT BOOMS MUST BE USED DURING DISCHARGES FROM EXISTING / USED PIPE OR AS DIRECTED BY PERMIT REQUIREMENTS.
6. PREVENT EROSION, STREAMBED SCOUR, SUSPENSION OF SEDIMENTS AND EXCESSIVE STREAMFLOW BY PROPER DESIGN OF STRUCTURE, REGULATING THE WATER DISCHARGE RATE AS WELL AS USE OF ENERGY DISSIPATION DEVICE(S) AND SEDIMENT BARRIERS, AS NECESSARY.

DISCHARGE STRUCTURE FOR  
HYDROSTATIC TEST WATER

FIGURE WD-2

DWG. ES-0026

REV.

Q:\S-U\SPE\2013-200.00\AutoCAD\Final\es0027.dwg

Wayne Siora  
5/29/2014 2:09 PM

I.G. ES0027.DWG

OPTION A

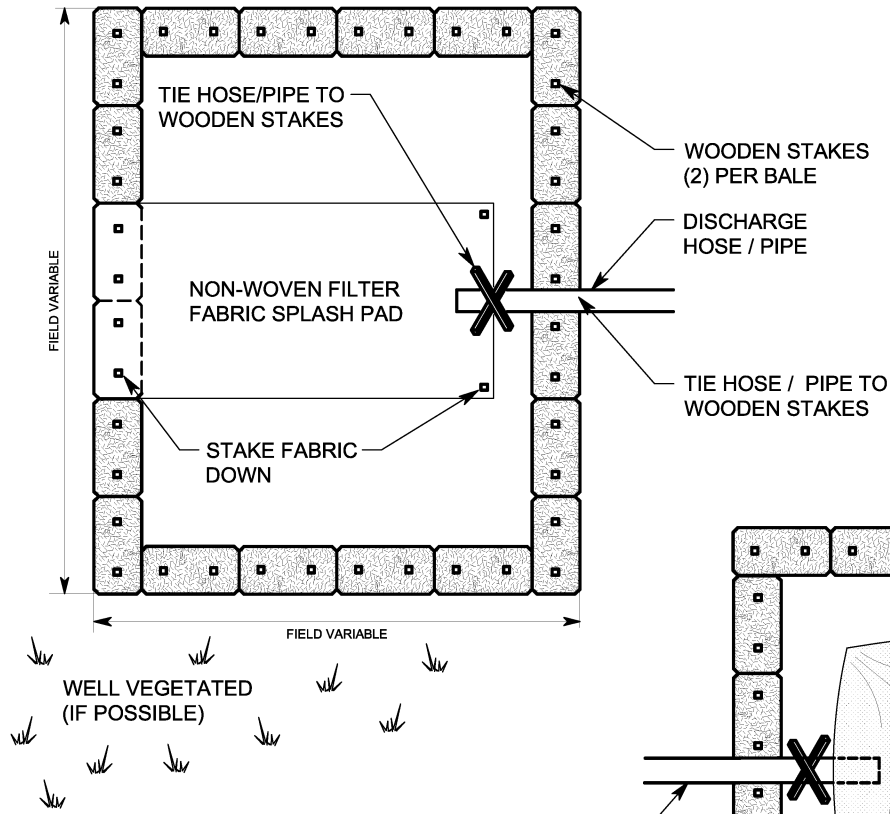

OPTION B

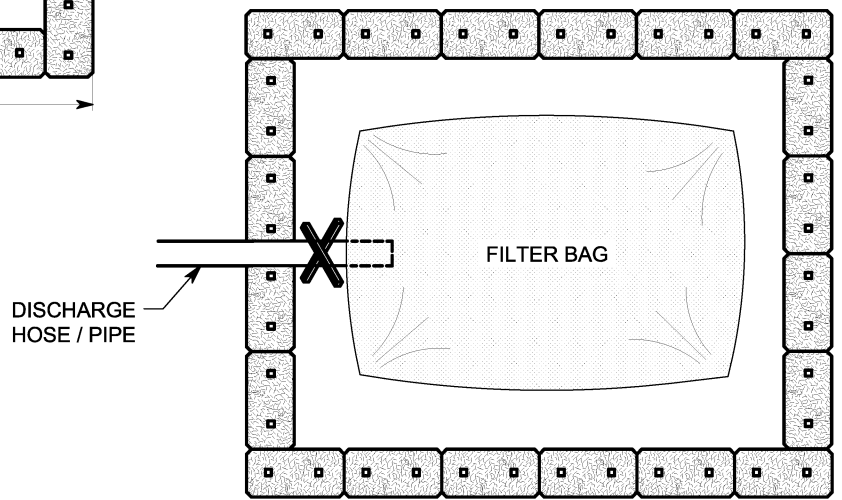

PLAN VIEW

NOT TO SCALE

NOTES:

1. SIZE AND DIMENSION OF DEWATERING STRUCTURE, INCLUDING NUMBER OF STRAW BALES USED, WILL VARY DEPENDING ON VOLUME OF WATER DISCHARGED, RATE OF DISCHARGE AND SITE CONDITIONS, SUCH AS THE TYPE AND AMOUNT OF SEDIMENT WITHIN THE DISCHARGE WATER.
2. PREVENT EROSION, STREAMBED SCOUR, SUSPENSION OF SEDIMENTS AND EXCESSIVE STREAMFLOW BY PROPER DESIGN OF STRUCTURE, REGULATING THE WATER DISCHARGE RATE AS WELL AS USE OF ENERGY DISSIPATION DEVICE(S) AND SEDIMENT BARRIERS, AS NECESSARY.
3. MONITOR AND CONDUCT DISCHARGES IN A MANNER THAT DOES NOT CAUSE EROSION AND DOES NOT RESULT IN SILT-LADEN WATER FLOWING INTO ANY WATERBODY OR WETLAND.
4. DO NOT DEPOSIT SAND, SILT, AND/OR SEDIMENT INTO SENSITIVE ENVIRONMENTAL RESOURCE AREAS, INCLUDING WETLANDS, WATERBODIES, CULTURAL RESOURCE SITES, AND SENSITIVE SPECIES HABITATS. STOP DEWATERING ACTIVITIES IF SUCH DEPOSITION IS OCCURRING AND ENSURE THE DESIGN OF THE DISCHARGE IS CHANGED TO PREVENT REOCCURRENCE.
5. ABSORBENT BOOMS MUST BE USED DURING DISCHARGES FROM EXISTING / USED PIPE OR AS DIRECTED BY PERMIT REQUIREMENTS.
6. FILTER BAGS SHOULD BE INSTALLED ACCORDING TO THE DETAILS SHOWN IN "FILTER BAG" FIGURE.
7. REMOVE STRUCTURE AS SOON AS PRACTICABLE AFTER COMPLETION OF WATER DISCHARGES.

OPTIONS FOR SMALL WATER DISCHARGES

FIGURE WD-3

DWG. ES-0027

REV.

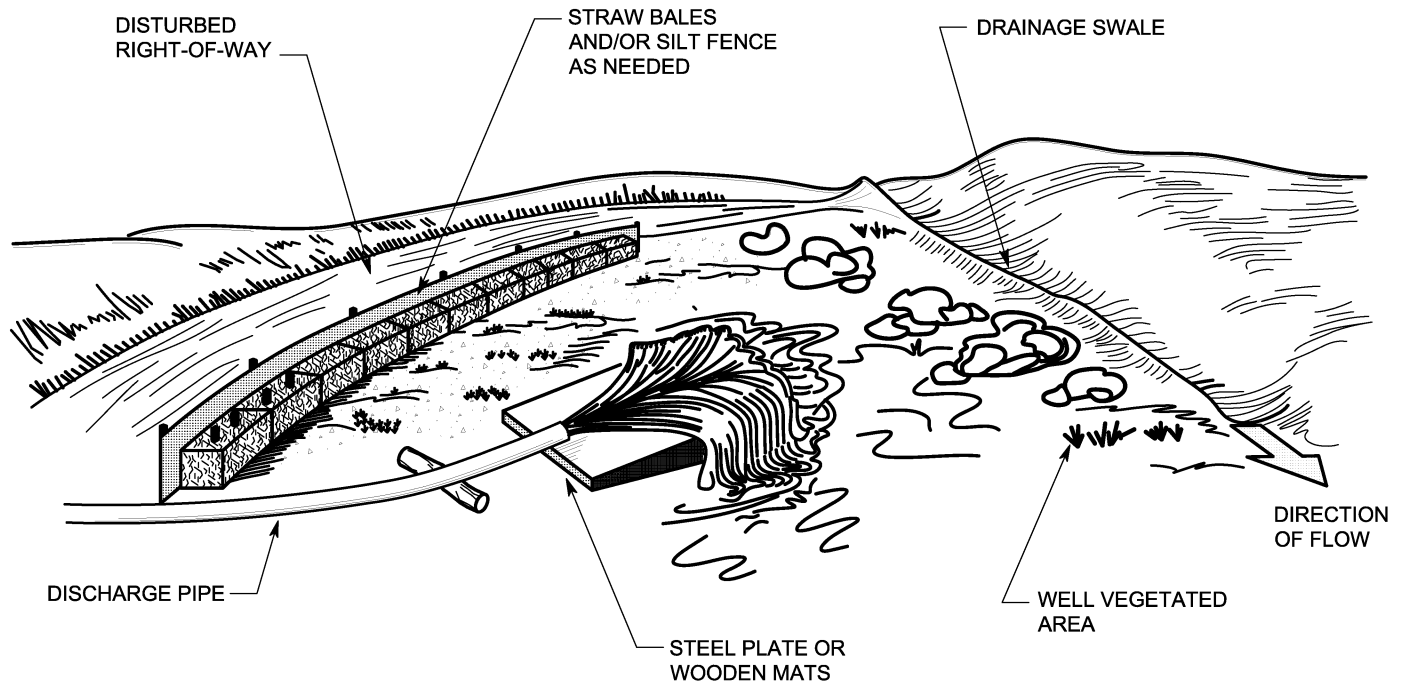

NOTES:

1. USE BACKHOE BUCKET OR DOZER BLADE TO ANCHOR DISCHARGE PIPE.
2. ON FLAT TERRAIN, USE STACKED STRAW BALES AND SILT FENCE AS NEEDED TO DIVERT WATER AWAY FROM DISTURBED RIGHT-OF-WAY.

DISCHARGE OF HYDROSTATIC TEST WATER TO A SURFACE WATER

FIGURE WD-4

Q:\S-U\SPE\2013-200.00\AutoCAD\Final\es0029.dwg

Wayne Sicora  
5/29/2014 2:43 PM

I.G. ES0029.DWG

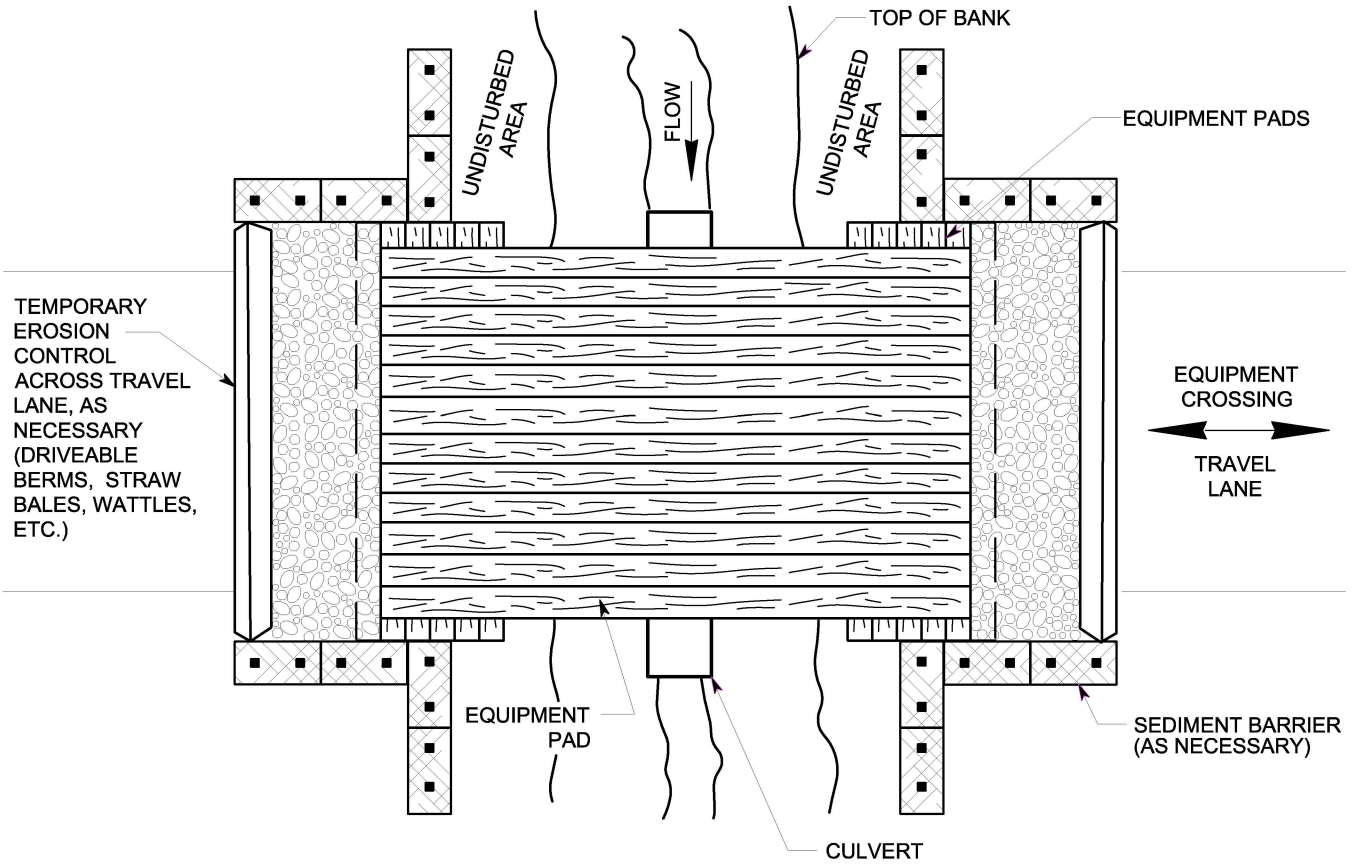

PLAN VIEW

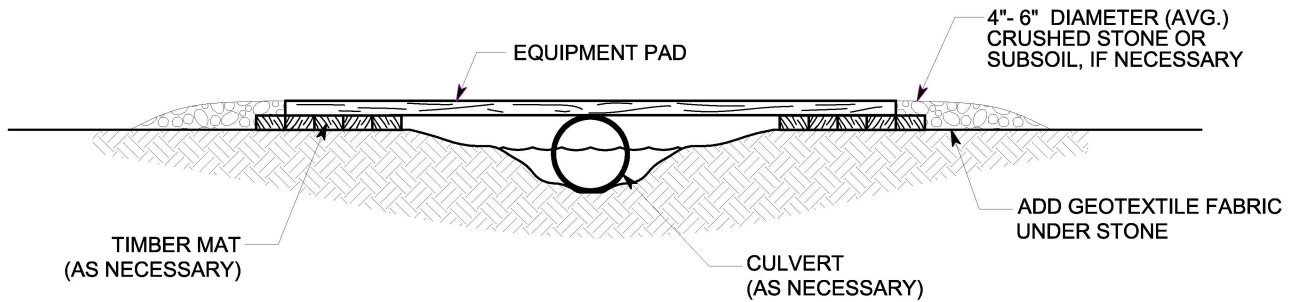

CROSS SECTION VIEW

NOTES:

1. TEMPORARY SEDIMENT BARRIER CONSISTS OF SILT FENCE AND/ OR STRAW BALES, OR OTHER APPROPRIATE MATERIAL.
2. NUMBER AND DIAMETER OF CULVERTS, AS WELL AS USE OF CULVERTS, WILL DEPEND ON SITE-SPECIFIC CONDITIONS.
3. EQUIPMENT PAD, TYPICALLY CONSTRUCTED OF HARDWOOD, SHALL BE IN GOOD CONDITION AND MUST ACCOMMODATE THE LARGEST EQUIPMENT USED. ADDITIONAL EQUIPMENT PADS CAN BE PUT SIDE BY SIDE IF EXTRA WIDTH IS REQUIRED. BRIDGE MUST SPAN FROM TOP OF BANK TO TOP OF BANK.
4. CRUSHED STONE OR SUBSOIL MAY BE USED AS ILLUSTRATED, IF NECESSARY, WITHIN TRAVEL LANE AS RAMP.
5. CONSTRUCT AND MAINTAIN BRIDGE TO WITHSTAND THE HIGHEST EXPECTED FLOW WHILE BRIDGE IS IN USE AND PREVENT SOIL FROM ENTERING WATERBODY. DO NOT USE SOIL TO CONSTRUCT OR STABILIZE BRIDGE.

TEMPORARY EQUIPMENT BRIDGE  
(EQUIPMENT PADS WITH  
OR WITHOUT CULVERTS)

FIGURE BR-1

DWG. ES-0029

REV.

Q:\S-U\SPE\2013-200.00\AutoCAD\Final\es0030.dwg

Wayne Sicora  
6/3/2014 11:36 AM

I.G. ES0030.DWG

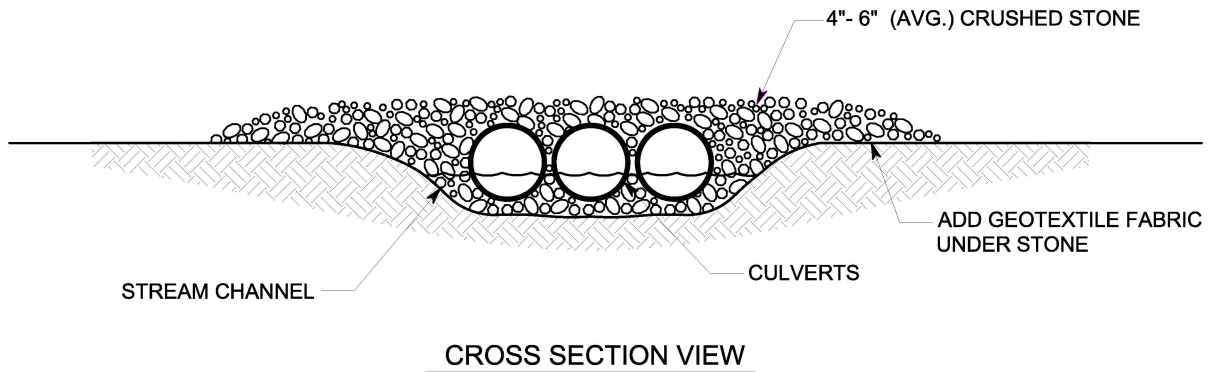
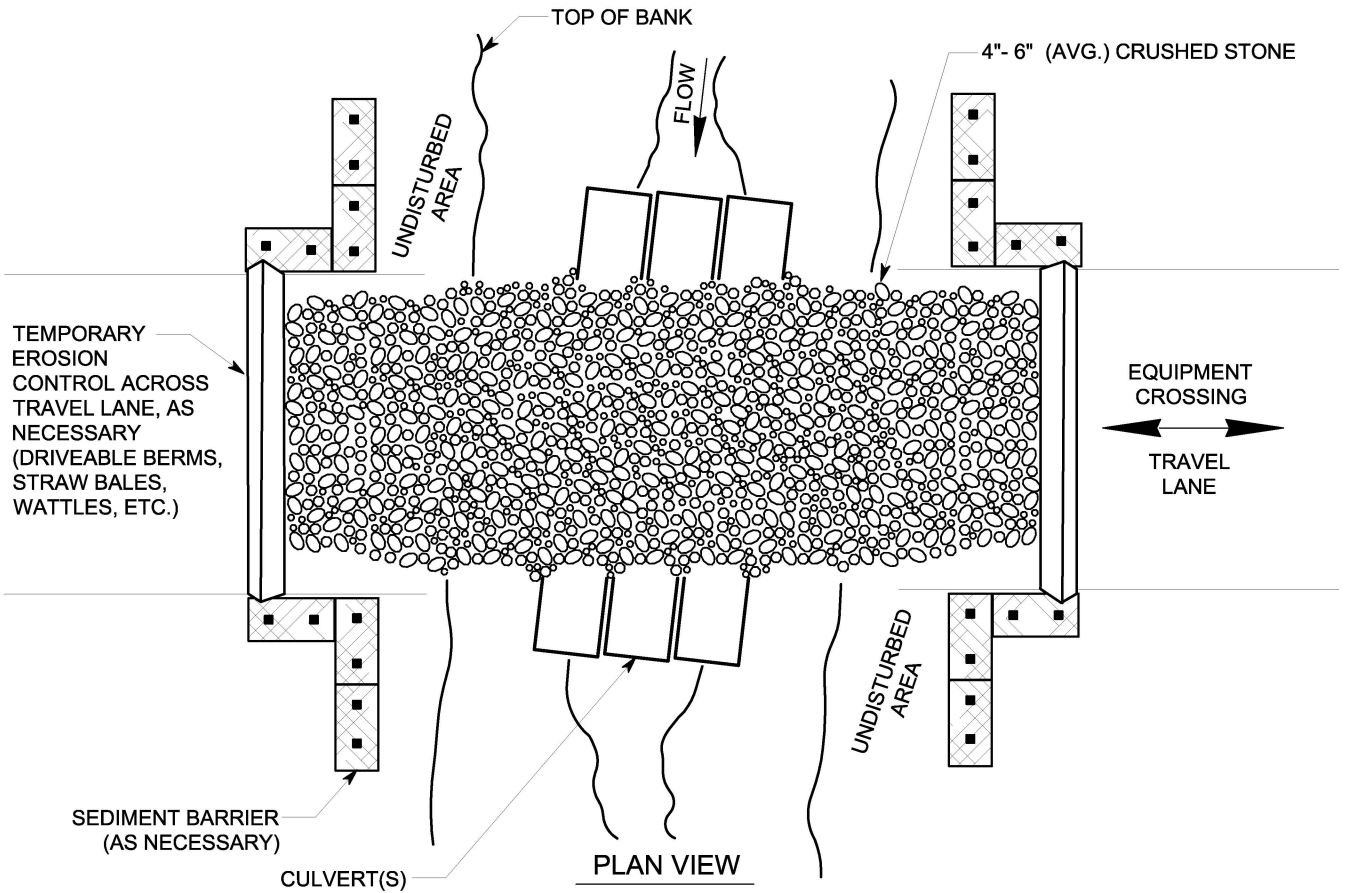

**NOTES:**

1. NUMBER AND DIAMETER OF CULVERTS WILL DEPEND ON SITE-SPECIFIC CONDITIONS. USE CULVERTS A MINIMUM OF 12-INCH DIAMETER.
2. ALIGN CULVERTS TO PREVENT EROSION AND STREAMBED SCOUR.
3. TEMPORARY SEDIMENT BARRIER CONSISTS OF SILT FENCES AND/OR STRAW BALES, OR OTHER APPROPRIATE MATERIALS.
4. ATTEMPT TO REMOVE ALL IMPORTED ROCK DURING REMOVAL OF THE BRIDGE.
5. DO NOT USE SOIL TO CONSTRUCT OR STABILIZE BRIDGES.

**TEMPORARY EQUIPMENT BRIDGE  
(CRUSHED STONE WITH CULVERTS)**

**FIGURE BR-2**

DWG. ES-0030

REV.

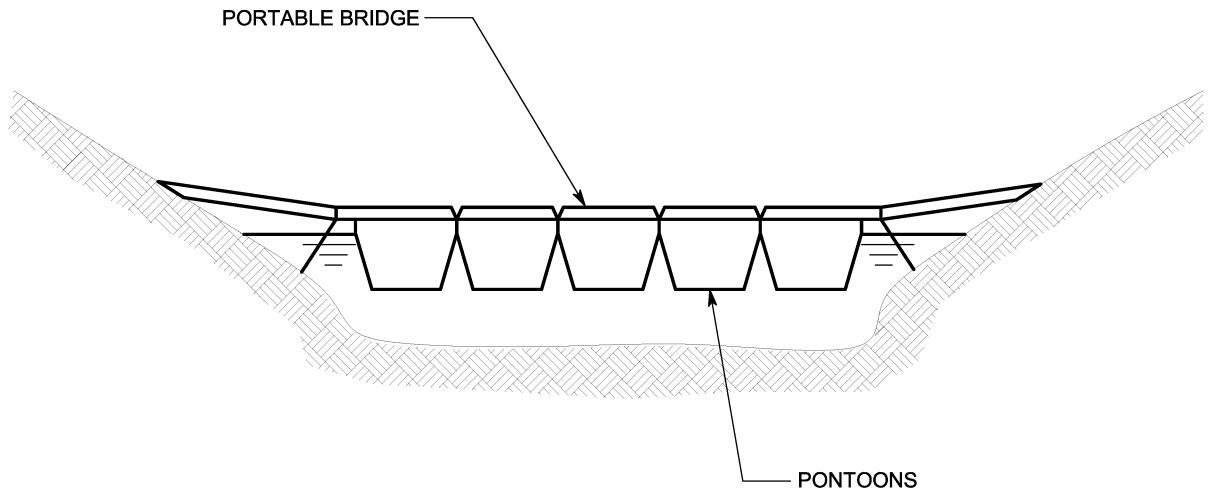

NOTES:

1. STABILIZE EDGES WITH SANDBAGS OR STONE.
2. REMOVE BRIDGE DURING CLEANUP.

TEMPORARY EQUIPMENT BRIDGE  
(FLEXI-FLOAT OR PORTABLE BRIDGE)

FIGURE BR-3

DWG. ES-0031

REV.

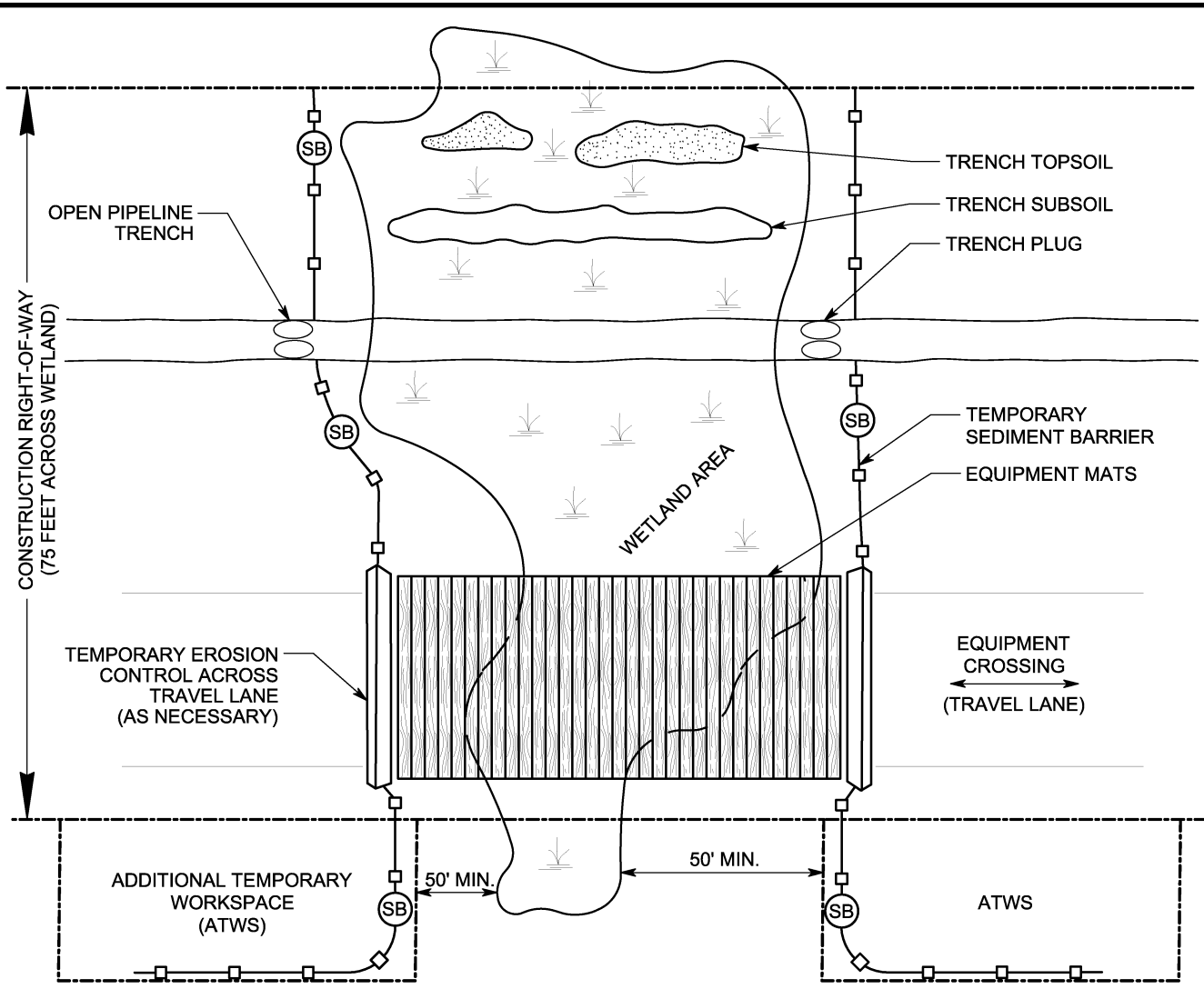

NOTES:

1. IN WETLANDS, EQUIPMENT MATS OR LOW GROUND WEIGHT EQUIPMENT SHALL BE UTILIZED IN SATURATED GROUND CONDITIONS.
2. LIMIT PULLING OF TREE STUMPS AND GRADING TO DIRECTLY OVER TRENCHLINE, EXCEPT IN SITUATIONS THAT THE CHIEF INSPECTOR AND ENVIRONMENTAL INSPECTOR DETERMINE SAFETY-RELATED CONSTRUCTION CONSTRAINTS REQUIRE GRADING OR THE REMOVAL OF STUMPS FROM UNDER THE WORKING SIDE.
3. SEGREGATE THE TOP 12 INCHES OF TOPSOIL WITHIN THE DITCHLINE IN WETLANDS, EXCEPT IN AREAS WHERE STANDING WATER IS PRESENT OR SOILS ARE SATURATED.
4. DO NOT TRENCH THE WETLAND UNTIL THE PIPELINE IS ASSEMBLED AND READY FOR LOWERING IN.
5. CONCRETE COATING OR PIPELINE WEIGHTS OF AN APPROPRIATE TYPE, WEIGHT AND SPACING WILL BE USED AS REQUIRED. NO CONCRETE COATING ACTIVITIES WITHIN 100 FEET OF A WETLAND OR WATERBODY BOUNDARY, UNLESS THE LOCATION IS AN EXISTING INDUSTRIAL SITE DESIGNATED FOR SUCH USE.
6. INSTALL SEDIMENT BARRIERS (SB) ALONG THE EDGE OF THE CONSTRUCTION RIGHT-OF-WAY AS NECESSARY TO CONTAIN SPOIL AND SEDIMENT WITHIN THE CONSTRUCTION RIGHT-OF-WAY THROUGH WETLANDS.
7. IN THE TRAVEL LANE, SEDIMENT BARRIERS MAY CONSIST OF REMOVABLE SEDIMENT BARRIERS OR DRIVABLE BERMS.
8. AT THE BASE OF SLOPES (GREATER THAN 5 PERCENT) THAT ARE LESS THAN 50 FEET FROM A WETLAND, INSTALL AND MAINTAIN TEMPORARY SEDIMENT BARRIERS ACROSS THE ENTIRE CONSTRUCTION RIGHT-OF-WAY UNTIL REVEGETATION IS SUCCESSFUL.
9. NO FERTILIZER OR LIME SHALL BE USED WITHIN WETLANDS.
10. DEWATER THE TRENCH IN A MANNER THAT DOES NOT CAUSE EROSION OR RESULT IN SILT-LADEN WATER FLOWING INTO ANY WETLAND.

TYPICAL STANDARD  
WETLAND CROSSING

FIGURE WC-1

DWG.	ES-0032	REV.
------	---------	------

Q:\S-U\SPE\2013-200.00\AutoCAD\Final\es0033.dwg

Wayne Siora  
5/29/2014 5:28 PM

I.G. ES0033.DWG

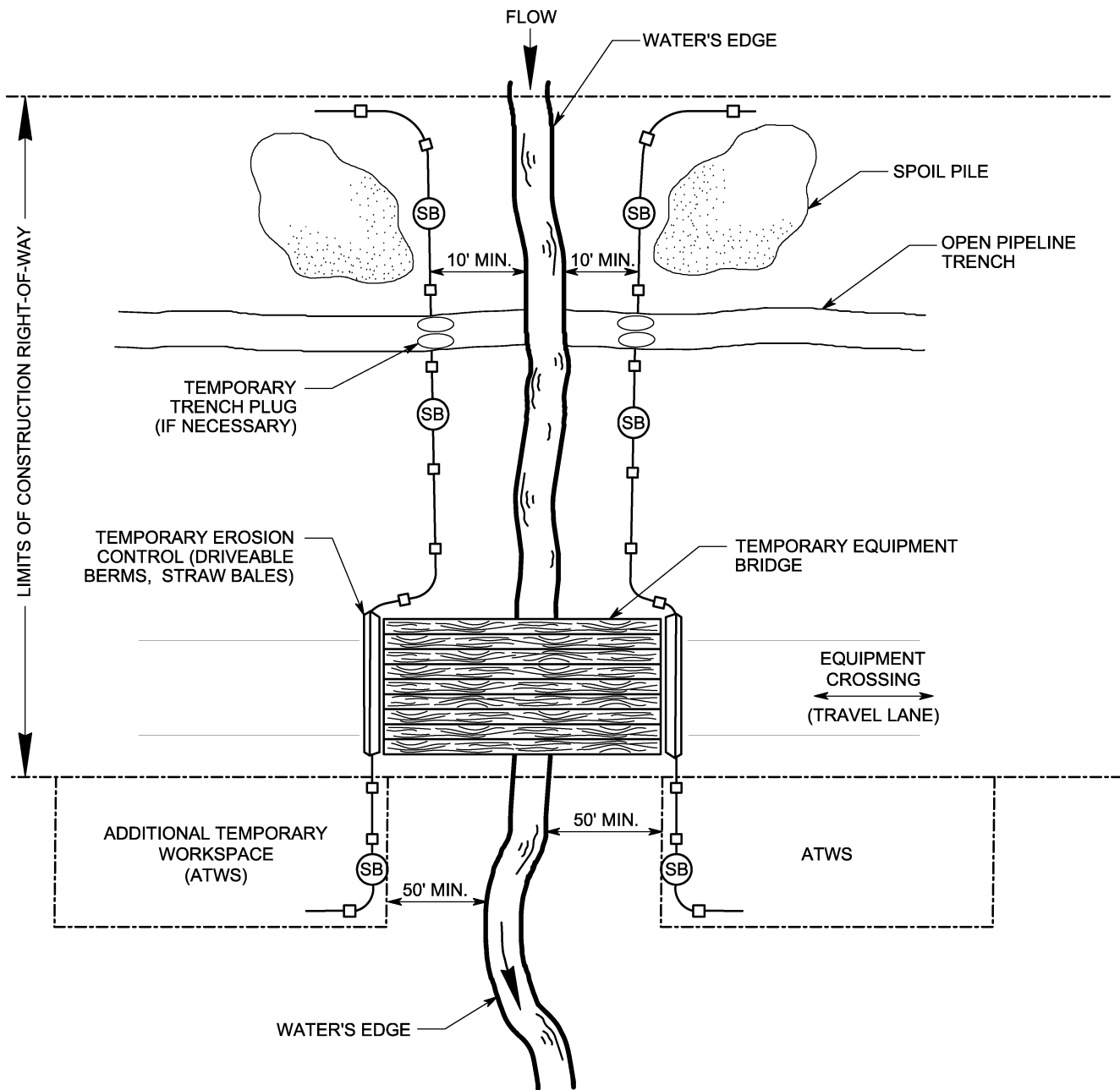

**NOTES:**

1. (SB) TEMPORARY SEDIMENT BARRIER OF SILT FENCE AND/OR STRAW BALES, OR APPROPRIATE MATERIALS.
2. FOR MINOR WATERBODIES, COMPLETE TRENCHING AND BACKFILLING IN THE WATERBODY (NOT INCLUDING BLASTING OR OTHER ROCK BREAKING MEASURES) WITHIN 24 CONTINUOUS HOURS. IF A FLUME IS INSTALLED WITHIN THE WATERBODY DURING MAINLINE ACTIVITIES, IT CAN BE REMOVED JUST PRIOR TO LOWERING IN THE PIPELINE. THE 24-HOUR TIMEFRAME STARTS AS SOON AS THE FLUME IS REMOVED.
3. FOR INTERMEDIATE WATERBODIES (>10 FEET TO 100 FEET WIDE MEASURED WATER'S EDGE TO EDGE), COMPLETE TRENCHING AND BACKFILLING IN THE WATERBODY (NOT INCLUDING BLASTING OR OTHER ROCK BREAKING MEASURES) WITHIN 48 CONTINUOUS HOURS, UNLESS SITE-SPECIFIC CONDITIONS MAKE COMPLETION WITHIN 48 HOURS INFEASIBLE.

TYPICAL WET  
WATERBODY CROSSING

FIGURE WC-2

DWG.	ES-0033	REV.
------	---------	------

Q:\S-U\SPE\2013-200.00\AutoCAD\Final\es0034.dwg

Wayne Sicora  
6/3/2014 11:38 AM

I.G. ES0034.DWG

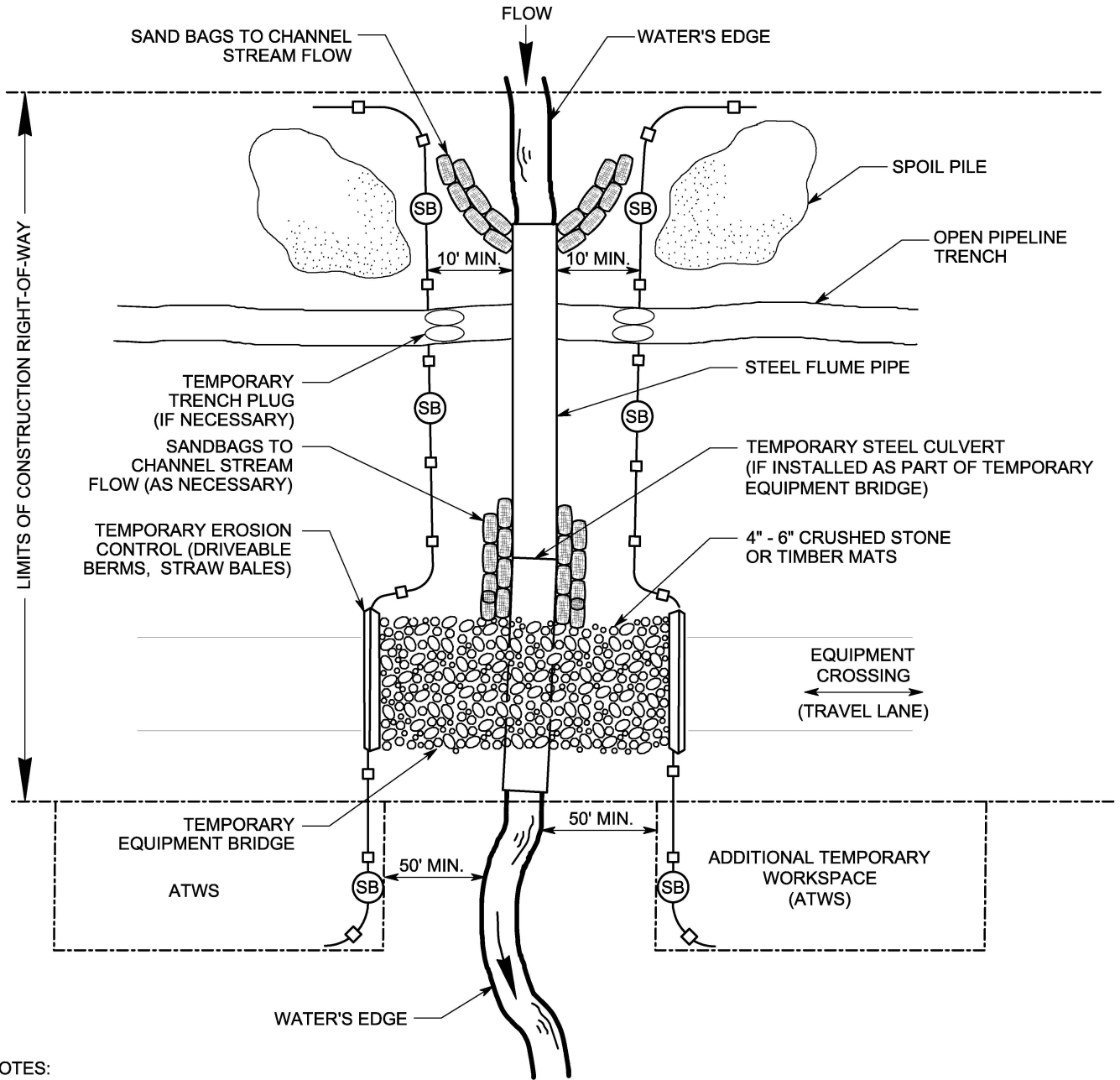

**NOTES:**

1. (SB) TEMPORARY SEDIMENT BARRIER OF SILT FENCE AND/ OR STRAW BALES, OR OTHER APPROPRIATE MATERIALS.
2. SAND BAGS MUST BE FILLED WITH SAND FREE OF SILT, ORGANICS, AND OTHER MATERIAL.
3. ENSURE SANDBAGS ARE INSTALLED BEFORE PLACING FLUME PIPE.
4. ALIGN FLUME(S) TO PREVENT BANK EROSION AND STREAM SCOUR.
5. CONDUCT ALL IN-STREAM ACTIVITY (EXCEPT BLASTING OR OTHER ROCK BREAKING MEASURES) WITH THE FLUME(S) IN PLACE. FLUME PIPE(S) MAY NOT BE REMOVED FOR LOWERING IN PIPE OR INITIAL STREAMBED RESTORATION EFFORTS.
6. THE ENDS OF THE FLUME AND CULVERT MUST EXTEND TO AN UNDISTURBED AREA.
7. CONTRACTOR TO DETERMINE ACTUAL NUMBER AND SIZE OF FLUMES AND CULVERTS REQUIRED BASED ON STREAM WIDTH AND STREAM FLOW RATE AT THE TIME OF CROSSING.
8. WATER ACCUMULATING WITHIN THE WORK AREA SHALL BE PUMPED TO A FILTER BAG OR DEWATERING STRUCTURE PRIOR TO DISCHARGING INTO ANY SURFACE WATER.

**TYPICAL FLUME  
WATERBODY CROSSING**

**FIGURE WC-3**

DWG. **ES-0034**

REV.

Q:\S-U\SPE\2013-200.00\AutoCAD\Final\es0035.dwg

Wayne Siora  
6/3/2014 11:41 AM

I.G. ES0035.DWG

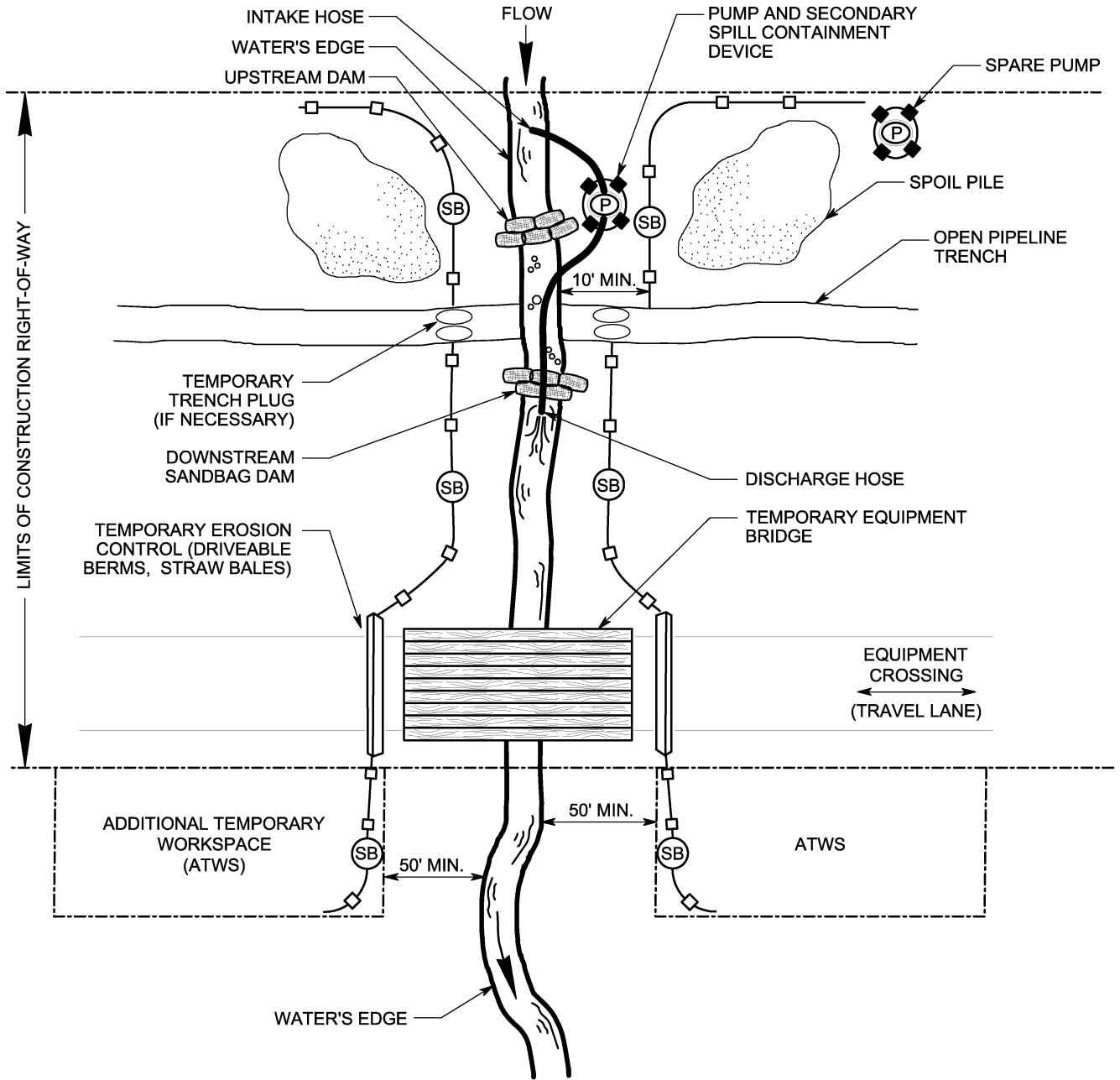

NOTES:

1. (SB) TEMPORARY SEDIMENT BARRIER OF SILT FENCE AND/ OR STRAW BALES, OR OTHER APPROPRIATE MATERIALS
2. INSTALL AND SEAL SANDBAGS UPSTREAM AND DOWNSTREAM OF THE CROSSING.
3. CREATE AN UPSTREAM SUMP USING SANDBAGS IF NATURAL SUMP IS UNAVAILABLE FOR THE INTAKE HOSE.
4. EXCAVATE ACROSS STREAM CHANNEL FOLLOWING WATER REROUTING.
5. DO NOT REFUEL OR STORE FUEL WITHIN 100 FEET OF THE WATERBODY. IF NOT FEASIBLE, ALTERNATIVE METHODS MUST BE APPROVED BY ENVIRONMENTAL INSPECTOR.
6. MONITOR PUMPS AT ALL TIMES DURING STREAM CROSSING PROCEDURE.
7. (P) USE SUFFICIENT PUMPS, INCLUDING ONSITE BACKUP PUMPS, TO MAINTAIN DOWNSTREAM FLOW.
8. SCREEN PUMP INTAKES. PREVENT SCOURING WITHIN WATERBODY BY HOSE DISCHARGE.

TYPICAL DAM-AND-PUMP  
WATERBODY CROSSING

FIGURE WC-4

DWG. ES-0035

REV.

Q:\S-U\SPE\2013-200.00\AutoCAD\Final\es0036.dwg

Wayne Sicora  
6/9/2014 4:33 PM

I.G. ES0036.DWG

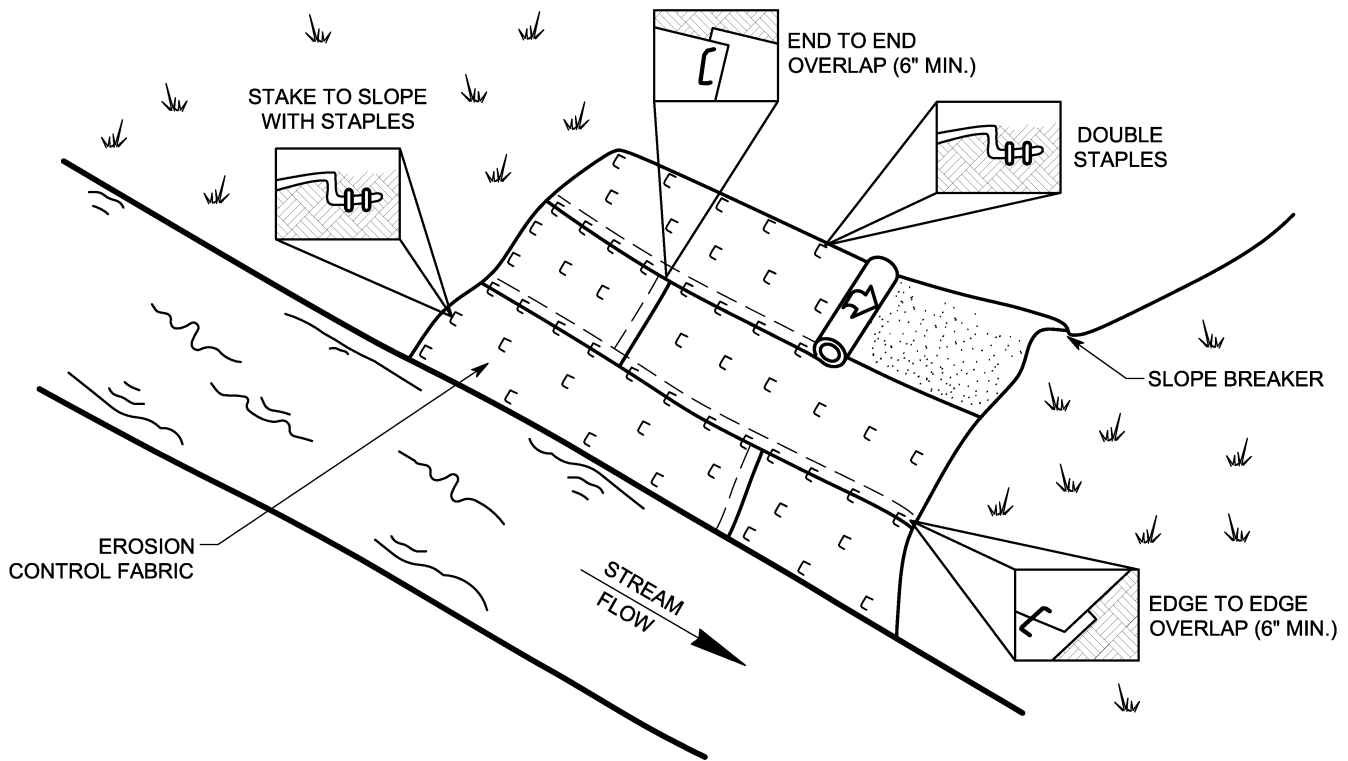

**NOTES:**

1. EROSION CONTROL BLANKETS (FABRIC) SHALL BE PLACED ON THE BANKS OF FLOWING STREAMS WHERE VEGETATION HAS BEEN REMOVED OR AS DIRECTED BY THE ENVIRONMENTAL INSPECTOR.
2. EROSION CONTROL BLANKETS SHALL MEET THE REQUIREMENTS SPECIFIED IN THE E&S PLAN AND/OR AS DIRECTED BY THE ENVIRONMENTAL INSPECTOR.
3. STAPLES SHALL BE MADE OF 11 GAUGE WIRE, U-SHAPED WITH 6" LEGS AND A 1" CROWN. STAPLES SHALL BE DRIVEN INTO THE GROUND FOR THE FULL LENGTH OF THE STAPLE LEGS. ALTERNATELY 1" WOODEN PEGS 6" LONG AND BEVELED TO SECURE MATTING.
4. BLANKETS SHALL BE INSTALLED ACCORDING TO MANUFACTURER SPECIFICATIONS OR AS STATED BELOW:
  - EXTEND TOP OF BLANKET 2 FEET PAST THE UPPER EDGE OF THE HIGH WATER MARK. IF A SLOPE BREAKER IS PRESENT ON THE APPROACH SLOPE, BEGIN THE BLANKET ON THE UPHILL SIDE OF THE SLOPE BREAKER.
  - INSTALL BLANKET(S) ACROSS THE SLOPE IN THE DIRECTION OF THE WATER FLOW.
  - ANCHOR ("KEY") THE UPSTREAM EDGE OF THE BLANKET(S) INTO THE SLOPE USING A 6" DEEP TRENCH. DOUBLE STAPLE EVERY 12" BEFORE BACKFILLING AND COMPACTING TRENCH
  - OVERLAP THE EDGES OF PARALLEL BLANKETS A MINIMUM OF 6". PLACE THE UPPER BLANKET OVER THE LOWER BLANKET (SHINGLE STYLE) AND STAPLE EVERY 12" ALONG THE LENGTH OF THE EDGE.
  - WHEN BLANKET ENDS ARE ADJOINED, PLACE THE UPSTREAM BLANKET OVER THE DOWNSTREAM BLANKET (SHINGLE STYLE) WITH APPROXIMATELY 6" OF OVERLAP AND STAPLE THROUGH THE OVERLAPPED AREA EVERY 12".
  - STAPLE DOWN THE CENTER OF THE BLANKET(S), THREE STAPLES IN EVERY SQUARE YARD.
5. IN LIVESTOCK AREAS WHERE EROSION CONTROL BLANKETS ARE APPLIED TO THE STREAMBANKS, FENCING MAY BE USED IF NECESSARY TO EXCLUDE LIVESTOCK, WITH PERMISSION OF THE LANDOWNER.
6. MONITOR WASHOUTS, STAPLE INTEGRITY OR BLANKET MOVEMENT. REPLACE OR REPAIR AS NECESSARY.
7. DO NOT USE SYNTHETIC MONOFILAMENT MESH / NETTED MATERIALS IN AREAS DESIGNATED AS SENSITIVE WILDLIFE HABITAT, UNLESS THE PRODUCT IS SPECIFICALLY DESIGNED TO MINIMIZE HARM TO WILDLIFE.

NOT TO SCALE

**TYPICAL EROSION CONTROL  
BLANKETS ON STREAMBANKS**

**FIGURE WC-5**

DWG.	ES-0036	REV.
------	---------	------

Q:\S-U\SPE\2013-200.00\AutoCAD\Final\es0037.dwg

Wayne Siorca  
5/29/2014 5:44 PM

I.G. ES0037.DWG

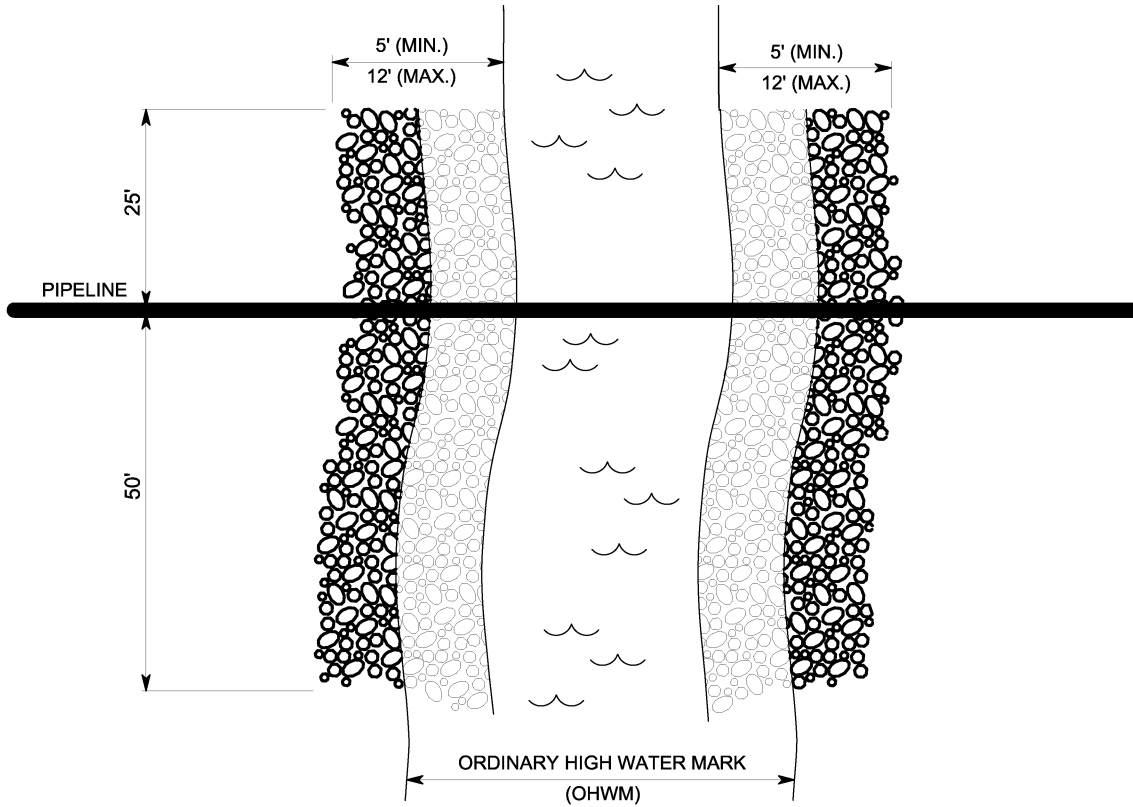

PLAN VIEW

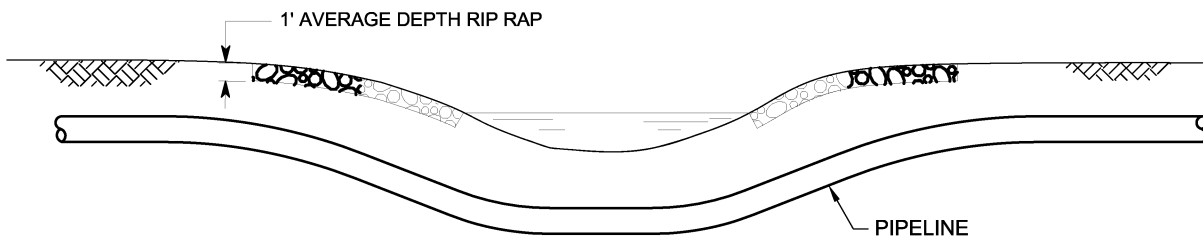

CROSS-SECTION VIEW

NOTES:

1. RIP-RAP SHALL NOT EXCEED 500 FEET IN LENGTH ALONG THE BANK.
2. RIP-RAP WILL NOT EXCEED AN AVERAGE OF ONE CUBIC YARD PER RUNNING FOOT BELOW THE OHWM.
3. RIP-RAP INSTALLATION SHALL BE IN COMPLIANCE WITH ALL APPLICABLE PERMITS.
4. RIP-RAP MUST BE CLEAN AND FREE OF SOIL AND DEBRIS.
5. RIP-RAP SHALL NOT BE PLACED IN A MANNER THAT IMPAIRS SURFACE WATER FLOW.
6. GEOTEXTILE FABRIC MAY BE INSTALLED BELOW RIP-RAP.

NOT TO SCALE

TYPICAL RIP-RAP  
PLACEMENT

FIGURE WC-6

DWG. ES-0037

REV.

Q:\S-U\SPE\2013-200.00\AutoCAD\Final\es0038.dwg

Wayne Sicora  
5/29/2014 6:08 PM

I.G. ES0038.DWG

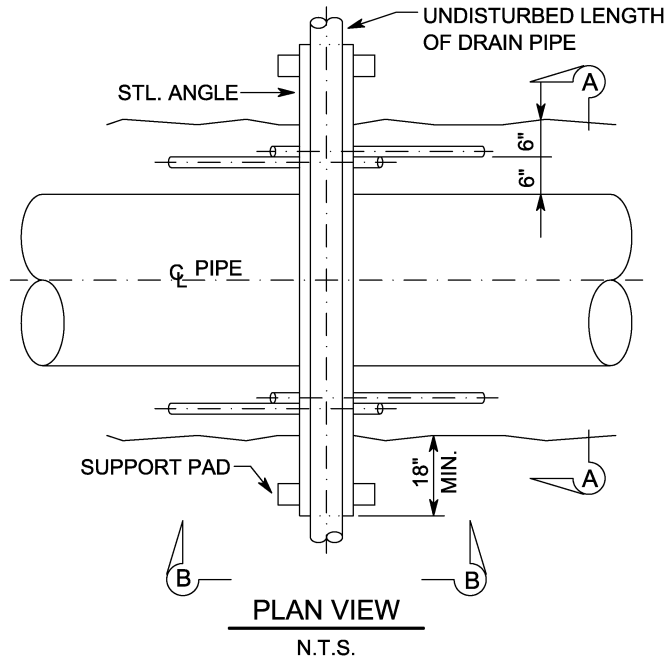

REMOVE EXPOSED OR DAMAGED TILE A MINIMUM OF 24" ON EITHER SIDE OF TRENCH TO INSURE A SATISFACTORY JOINT

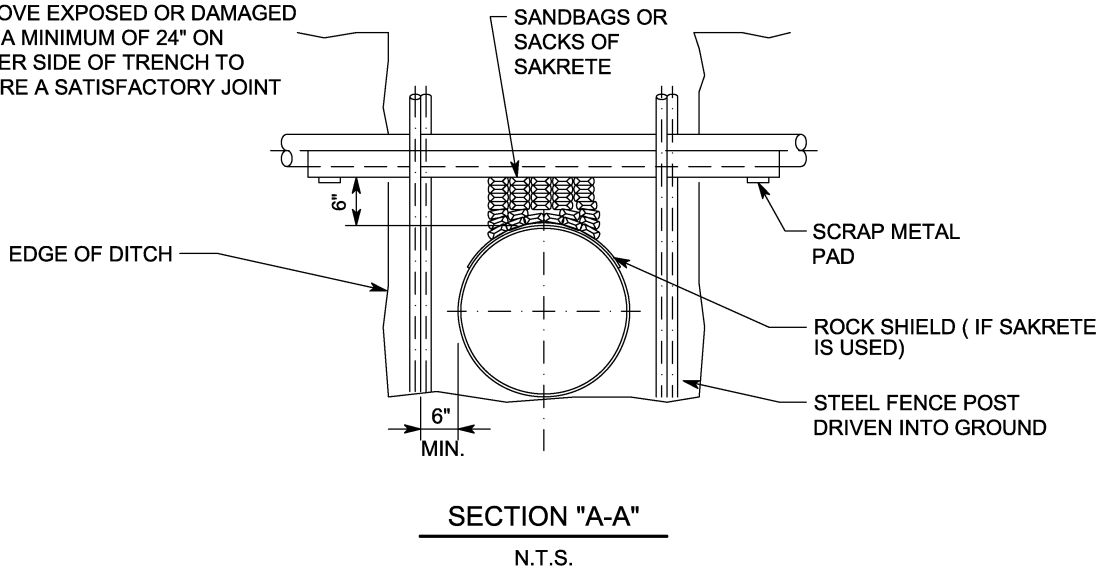

TO SUPPORT 4" & 6" TILE USE 4" x 1/4" ANGLE

"	8"	"	6" x 7/16"	"
"	10"	"	6" x 7/16"	"
"	12"	"	8" x 1/2"	"
"	16"	"	8" x 1/2"	"

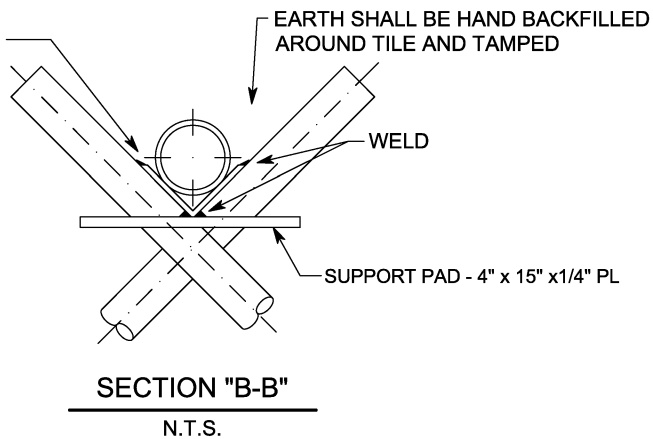

NOTE:  
USE OF SAKRETE SHALL REQUIRE PRIOR COMPANY APPROVAL.

**DRAIN TILE REPAIR  
PROCEDURE**

**FIGURE SU-1**

DWG. ES-0038

REV.

**WATERBODY REFERENCE CITING FERC REQUIREMENTS**



## APPENDIX B: Waterbody Reference Citing FERC Requirements

Waterbodies may be specifically identified or recognized by the States or authorized Indian Tribe for water use, value or quality, such as fisheries. FERC's *Wetland and Waterbody Construction and Mitigation Procedures* (Procedures) contain specific requirements with regards to state-designated fisheries which are summarized in the table below. This table is a general reference of waterbody construction techniques and restrictions required by the FERC Procedures, 2013 version. Project-specific permits obtained for a given project may be more restrictive and must be followed (Refer to project-specific Clearance Package/Permit Book).

FERC Waterbody Type <sup>a</sup>	Crossing Width <sup>b</sup>	Construction Crossing Method <sup>c</sup>	Seasonal Timing Restriction <sup>d</sup>	Waterbody Construction Duration <sup>e</sup>
<b>Not Designated Fisheries</b>				
<i>MINOR</i>	<i>≤ 10 feet</i>	Dry or Wet	No	24 hours
<i>INTERMEDIATE</i>	<i>&gt; 10 feet but ≤ 100 feet</i>	Dry or Wet	No	48 hours
<i>MAJOR</i>	<i>&gt; 100 feet</i>	Refer to site-specific plan	No	N/A
<b>Designated Fisheries</b>				
<i>MINOR</i>	<i>≤ 10 feet</i>	Dry only	Yes	N/A
<i>INTERMEDIATE</i>	<i>&gt; 10 feet but ≤ 100 feet</i>	Dry or Wet	Yes	N/A
<i>MAJOR</i>	<i>&gt; 100 feet</i>	Refer to site-specific plan	Yes	N/A
<p><sup>a)</sup> Waterbody types or classifications as defined in the FERC Procedures. Refer to Section 5.3 of E&amp;SCP.</p> <p><sup>b)</sup> Measured from the water's edge at the time of crossing.</p> <p><sup>c)</sup> "Dry" = Dry crossing includes dam-and-pump or flume crossing methods where the stream flow is isolated from the construction area. A dry crossing is generally required for crossings up to 30 feet wide for state designated fisheries or federally designated critical habitat.  "Wet" = Wet crossing generally refers to the open-cut method that allows continuous flow of the stream across the construction area.  "Refer to site-specific plan" = A plan is required for each major crossing as well as each waterbody or wetland that would be crossed using the HDD method requires a project-specific HDD Plan (refer to Section 4.4).</p> <p><sup>d)</sup> For designated fisheries, instream work must occur during the following seasonal time windows, unless expressly permitted or further restricted by the appropriate federal or state agency in writing on a site-specific basis:</p> <ul style="list-style-type: none"> <li>• coldwater fisheries construction must occur from June 1 through September 30.</li> <li>• coolwater and warmwater fisheries construction must occur from June 1 through November 30.</li> </ul> <p>NOTE: project-specific waterbody crossings may have other federal and state agency timing restrictions. Seasonal timing windows will be indicated within the project-specific waterbody crossing table and/or within the Environmental Clearance/Permit Book for the project. The FERC seasonal timing window restrictions do not apply to the installation or removal of equipment bridges.</p> <p><sup>e)</sup> The construction duration of the crossing officially begins with in-stream activities, including in-stream trenching, pipe installation, backfill, and restoration of the streambed contours. Duration does not apply to in-stream work for dry crossings, and does not apply to blasting activities.</p>				

**SEED MIX RECOMMENDATIONS**



## SEED MIX RECOMMENDATIONS: “NORTHERN ZONE”

The Northern Zone is generally defined as areas north of the northern borders of Arkansas and Tennessee.

### UPLAND AREAS

Lime	4.0 tons/acre
Fertilizer	1000 lbs./acre (10-20-20)
Mulch (Wheat Straw)	3.0 tons/acre

<b>Upland Seed Mix</b>	75 lbs./acre Pure Live Seed (PLS)
Kentucky Bluegrass	20%
Red Fescue <sup>1</sup>	20%
Kentucky 31 Tall Fescue <sup>1</sup>	15%
Redtop	10%
Perennial ryegrass	20%
White clover	5%
Birdsfoot Trefoil (Minimum 20% hard seed)	10%
<sup>1</sup> Fescue must be endophyte-free.	

<b>Pasture Mix</b>	20 lbs./acre PLS
<i>(For use only in disturbed pasture areas with landowner's permission.)</i>	
Kentucky Bluegrass	31%
Medium Red clover	26%
Norcen Trefoil	17%
Poly Perennial Rye	26%

**Recommended Seeding Dates**  
*(For the establishment of temporary or permanent vegetation.)*  
 Spring: March 15 - May 30  
 Fall: August 1 - October 15

### WINTER STABILIZATION

If restoration does not occur prior to October 15, seed the construction ROW with 1.5 bushels per acre of winter rye or similar variety of rye as requested by the landowner. Mulch the construction ROW at 3.0 tons per acre with wheat straw, including areas adjacent to streams and wetland crossings. Seed segregated topsoil piles with winter rye and mulch at a rate of 3.0 tons per acre.

### WETLAND AREAS

**DO NOT USE LIME OR FERTILIZER !!!**

Do not use fertilizer, lime, or mulch within wetlands unless required in writing by the appropriate federal or state agency (as identified in the Clearance Package/Permit Book). Mulch consists of weed-free straw, wood fiber hydromulch or some functional equivalent as approved by the EI and Chief Inspector. When used, apply mulch (wheat straw) at a rate of 3.0 tons/acre.

<b><u>Wetland Seed Mix</u></b>	
Annual Ryegrass	40 lbs./acre PLS



## SEED MIX RECOMMENDATIONS: “SOUTHERN ZONE”

The Southern Zone is generally defined as areas south of the northern borders of Arkansas and Tennessee.

### UPLAND AREAS

Lime (agricultural limestone)	2.5 tons/acre
Fertilizer (6-12-12)	950 lbs./acre
Mulch (Oats, Wheat or Bermudagrass Straw)	3.0 tons/acre

### Seed Mixture<sup>1</sup>

Sorghum, Sudangrass, or Sudangrass Hybrids <sup>2</sup>	40 lbs/acre Pure Live Seed (PLS)
Kentucky 31 Tall Fescue <sup>3</sup>	10 lbs/acre PLS
Big Bluestem	10 lbs/acre PLS
Indiangrass	10 lbs/acre PLS
Bermudagrass	10 lbs/acre PLS
Sericea Lespedeza <sup>4</sup>	10 lbs/acre PLS
White Clover <sup>4</sup>	5 lbs/acre PLS
Birdsfoot Trefoil <sup>4</sup>	10 lbs/acre PLS

<sup>1</sup> An alternative seed mixture may be requested by the landowner(s).

<sup>2</sup> These species may be sold under the following trade names: DeKalb SX17, Greentreat II, Greentreat III, Tastemaker DR, Tastemaker III, FFR202, or Sordan 79.

<sup>3</sup> Fescue must be endophyte-free.

<sup>4</sup> Legumes should be treated with a species specific inoculate prior to seeding. Legume seed and soil should be scarified.

### Recommended seeding dates

*(For establishment of temporary or permanent vegetation.)*

Spring: March 15 - May 30

Fall: August 1 - October 15

### WINTER STABILIZATION

If restoration does not occur prior to October 15, seed the construction ROW with 1.5 bushels per acre of winter rye or similar variety of rye as requested by the landowner. Mulch construction ROW at 3.0 tons per acre with wheat straw, including areas adjacent to stream and wetland crossings. Seed segregated topsoil piles with winter rye and mulch at a rate of 3.0 tons per acre.

### WETLAND AREAS

### **DO NOT USE LIME OR FERTILIZER !!!**

Do not use fertilizer, lime, or mulch within wetlands unless required in writing by the appropriate federal or state agency (as identified in the Clearance Package/Permit Book). Mulch consists of weed-free straw, wood fiber hydromulch or some functional equivalent as approved by the EI and Chief Inspector. When used, apply mulch (Oats, Wheat, or Bermudagrass straw) at a rate of 3.0 tons/acre.

### Wetland Seed Mix:

Annual Ryegrass	40 lbs/acre PLS
-----------------	-----------------